

Keysight Technologies

N3300 Series

DC Electronic Loads

Data Sheet

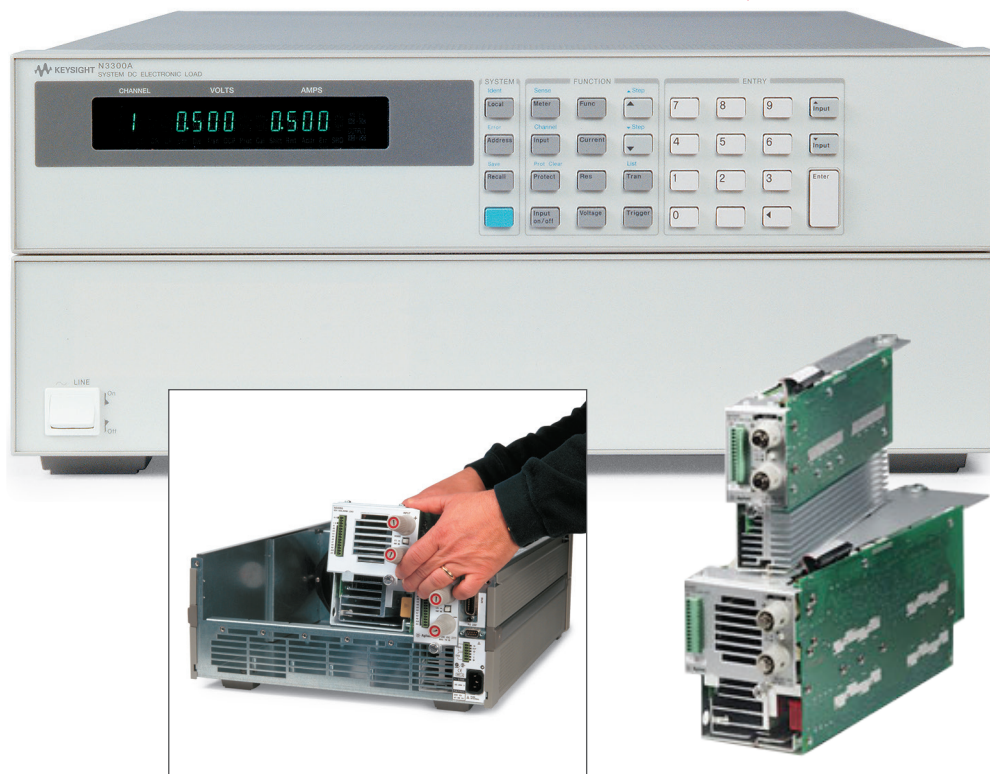

Increase your manufacturing test throughput with fast electronic loads

- Increase test system throughput
- Lower cost of ownership
- Decrease system development time
- Increase system reliability
- Increase system flexibility
- Stable operation down to zero volts
- DC connection terminal for ATE applications

Increase Test Throughput

Today's high volume manufacturing requires optimization of test system throughput, to maximize production volume without increasing floorspace. The N3300 Series electronic loads can help you in a number of ways to achieve this goal.

Reduced command processing time:

Commands are processed more than 10 times faster than previous electronic loads.

Automatically execute stored command sequences:

"Lists" of downloaded command sequences can execute independent of the computer, greatly reducing the electronic load command processing time and computer interaction time during product testing.

Programmable delay allows for either simultaneous or sequential load changes:

This is the most multiple output DC power supplies, simulating real-life loading patterns, with a minimum of programming commands.

Buffer measurement data:

Voltage, current, and power measurements can be buffered for later readback to the computer, reducing computer interaction.

Control measurement speed vs. accuracy:

Decrease the number of measurement samples to achieve greater measurement speed, or increase the number of samples to achieve higher measurement accuracy. You can optimize your measurements for each test.

Control rising and falling slew rates separately:

Reduce rate of loading change when necessary for DUT stability or to simulate real life conditions, but otherwise change load values at maximum rate.

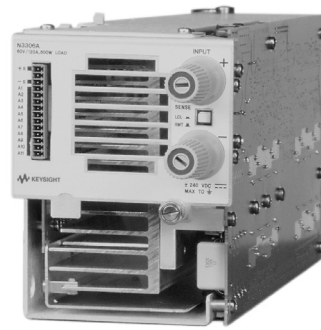

Standard DC connectors



Option UJ1 8 mm screw connectors

Increase System Flexibility...for Both Present and Future Requirements

Most power supply and battery charger test systems designed today need to test a variety of products and/or assemblies. In the future, additional products or assemblies may be needed. A flexible family of electronic loads makes present system design and future growth much easier.

Test low voltage power supplies:

The N3300 Series electronic loads operate with full stability down to zero volts. Many other electronic loads available today have been found to become unstable in the operating region below one volt. When designing power supply test platforms, the trend towards lower voltage requirements should be taken into account. Refer to the specification and supplemental characteristic tables for details of lower voltage operating characteristics.

Choose DC load connection method:

Automatic test systems need consistency and reliability. Option UJ1 8 mm screw connectors provide a simple screw onto which your wires, terminated with insulated ring terminals, may be securely mounted. This optional connector is specifically designed for test systems. Wires may exit the plastic cover in any direction, and multiple wires may be placed on each screw terminal for easy parallel load connections. Up to AWG 4 wire may be used.

Applications which require repeated connections/disconnections are better suited to the standard connector. The standard connector accepts an unterminated wire, and may be hand-tightened. This connector is specifically designed for bench applications and short-term automated tests.

Design a system to test a variety of products:

This series consists of 2 mainframes and 6 modules. The N3300A mainframe is full rack width. It has 6 slots. The N3301A mainframe is half rack width. It has 2 slots. Any assortment of the 6 different modules can be configured into these mainframes, up to the slot capacity. The N3302A (150 watts), N3303A (250 watts), N3307A (250 Watts) and N3304A (300 watts) each require one slot. The N3305A (500 watts) and the N3306A (600 watts) each require 2 slots. The electronic load can be configured to supply exactly what you need now, and this modular design also allows for easy future reconfiguration.

Test high current power supplies:

Electronic load modules can be operated in parallel to provide additional current sinking capability.

Control the electronic load how you want to:

GPIB, RS232, and manual use of the front panel all provide complete control of these electronic loads. There are also analog programming and monitoring ports for those applications that utilize nonstandard interfaces, require custom waveforms, or utilize process control signals. Custom waveforms can also be created by downloading a "List" of load parameters. In addition, there is a built-in transient generator, which operates in all modes.

Quickly create powerful and consistent software:

All Keysight Technologies, Inc. electronic loads use the SCPI (Standard Commands for Programmable Instruments) command set. This makes learning the commands easy, because they are the same format as all other SCPI instruments. The resulting code is virtually self-documenting, and therefore easier to troubleshoot and modify in the future. Plug-n-Play drivers are also available to help you to integrate the loads into your standard software packages.

Make Measurements Easily and Accurately

The 16-bit voltage, current and power measurement system provides both accuracy and convenience. The alternative is using a DMM (digital multimeter) and MUX (multiplexer) along with a precision current shunt and a lot of extra wiring. Avoiding this complexity increases system reliability and makes the system easier to design and support. Current measurements in particular are more consistently accurate using the electronic load's internal system, because the wiring associated with an external precision current shunt may pick up noise.

Measure with all load modules simultaneously:

Testing multiple output DC power supplies and DC to DC converters can be very time consuming if each output must be tested sequentially. If measurements are being made through a MUX using one DMM, this is what will happen. Using the built-in measurement capabilities of the N3300 electronic loads, all outputs can be measured simultaneously. Alternatively, multiple single output power sources can be tested simultaneously.

Measure voltage and current simultaneously:

The N3300 measurement system has individual but linked current and voltage measurement systems. This means that voltage and current measurements are taken exactly simultaneously, which gives a true picture of the power supply under test's output at a particular moment in time. Some other electronic loads which feature internal measurement systems actually take current and voltage measurements sequentially, and therefore do not give as accurate a picture of momentary power.

Specifications

Table A-1 lists the specifications for the different load models. Specifications indicate warranted performance in the 25 °C ± 5 °C region of the operating temperature range. Specifications apply to normal and transient modes unless otherwise noted.

Table A-1

	N3302A	N3303A	N3304A	N3304-J01 Special order option	N3305A	N3306A	N3307A
Input ratings							
Current	0–30 A	0–10 A	0–60 A	0–60 A	0–60 A	0–120 A	0–30 A
Voltage	0–60 V	0–240 V	0–60 V	0–80 V	0–150 V	0–60 V	0–150 V
Maximum power @ 40 °C ¹	150 W	250 W	300 W	300 W	500 W	600 W	250 W
Input characteristic							

Operating contour

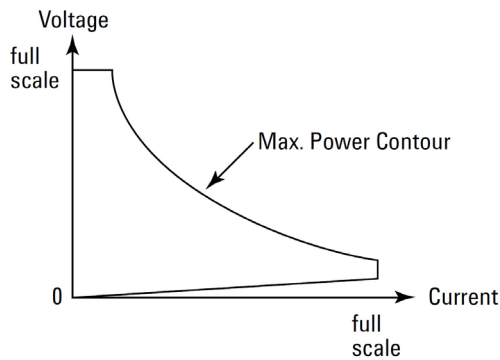

Derated current detail

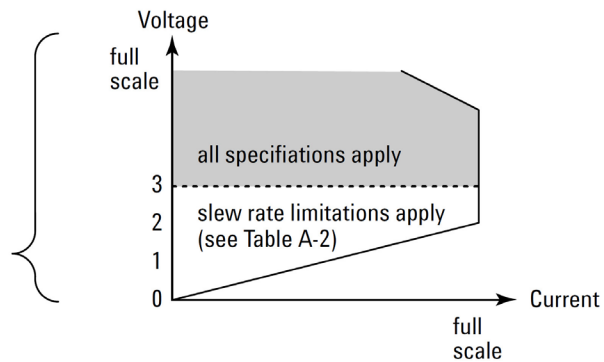

	N3302A	N3303A	N3304A	N3304-J01 Special order option	N3305A	N3306A	N3307A
Specified current @ low voltage operation							
2.0 V	30 A	10 A	60 A	60 A	60 A	120 A	30 A
1.5 V	22.5 A	7.5 A	45 A	45 A	45 A	90 A	22.5 A
1.0 V	15 A	5 A	30 A	30 A	30 A	60 A	15 A
0.5 V	7.5 A	2.5 A	15 A	15 A	15 A	30 A	7.5 A
0 V	0 A	0 A	0 A	0 A	0 A	0 A	0 A

1. Maximum continuous power available is derated linearly from 100% of maximum at 40 °C, to 75% of maximum at 55 °C.

Table A-1 states that maximum current is available down to 2 volts. Typically, however under normal operating conditions, the load can sink the maximum current down to the following voltages:

	N3302A	N3303A	N3304A	N3304-J01 Special order option	N3305A	N3306A	N3307A
Typical minimum operating voltage @ full scale current							
	1.2 V	1.2 V	1.2 V	1.2 V	1.4 V	1.4 V	1.4 V

Specifications (continued)

Table A-1

		N3302A	N3303A	N3304A	N3304-J01 Special order option	N3305A	N3306A	N3307A
Constant current mode¹								
Low range/High range		3 A/30 A	1 A/10 A	6 A/60 A	6 A/60 A	6 A/60 A	12 A/120 A	3 A/30 A
Regulation		10 mA	8 mA	10 mA	10 mA	10 mA	10 mA	10 mA
Low range accuracy	0.1% +	5 mA	4 mA	7.5 mA	7.5 mA	7.5 mA	15 mA	7.5 mA
High range accuracy	0.1% +	10 mA	7.5 mA	15 mA	15 mA	15 mA	37.5 mA	15 mA
Constant voltage mode¹								
Low range/High range		6 V/60 V	24 V/240 V	6 V/60 V	8 V/80 V	15 V/150 V	6 V/60 V	15 V/150 V
Regulation		5 mV	10 mV	10 mV	10 mV	10 mV	20 mV	10 mV
Low range accuracy	0.1% +	3 mV	10 mV	3 mV	5 mV	10 mV	3 mV	10 mV
High range accuracy	0.1% +	8 mV	40 mV	8 mV	12 mV	20 mV	8 mV	20 mV
Constant resistance mode¹								
Range 1 (I > 10% of current rating)		0.067–4 Ω	0.2–48 Ω	0.033–2 Ω	0.033–2.6 Ω	0.033–5 Ω	0.017–1 Ω	0.067–10 Ω
Range 2 (I > 1% of current rating)		3.6–40 Ω	44–480 Ω	1.8–20 Ω	2.4–26 Ω	4.5–50 Ω	0.9–10 Ω	9–100 Ω
Range 3 (I > 0.1% of current rating)		36–400 Ω	440–4800 Ω	18–200 Ω	24–260 Ω	45–500 Ω	9–100 Ω	90–1000 Ω
Range 4 (I > 0.01% of current rating)		360– 2000 Ω	4400– 12000 Ω	180– 2000 Ω	240– 2600 Ω	450– 2500 Ω	90– 1000 Ω	900– 2500 Ω
Current measurement¹								
Low range/High range		3 A/30 A	1 A/10 A	6 A/60 A	6 A/60 A	6 A/60 A	12 A/120 A	3 A/30 A
Low range accuracy ²	0.05% +	3 mA	2.5 mA	5 mA	5 mA	5 mA	10 mA	3 mA
High range accuracy ²	0.05% +	6 mA	5 mA	10 mA	10 mA	10 mA	20 mA	6 mA
Voltage measurement¹								
Low range/High range		6 V/60 V	24 V/240 V	6 V/60 V	8 V/80 V	15 V/150 V	6 V/60 V	15 V/150 V
Low range accuracy	0.05% +	3 mV	10 mV	3 mV	5 mV	8 mV	3 mV	8 mV
High range accuracy	0.05% +	8 mV	20 mV	8 mV	12 mV	16 mV	8 mV	16 mV
Power measurement¹								
Accuracy	0.1% +	0.4 W	1.2 W	0.6 W	0.8 W	1.6 W	1.3 W	0.9 W

1. Specification is \pm (% of reading + fixed offset). Measurement is 1000 samples. Specification may degrade when the unit is subject to an RF field of 3 V/meter, the unit is subject to line spikes of 500 V, or an 8 kV electrostatic discharge.

2. DC current accuracy specifications apply 30 seconds after input current is applied.

Supplemental Characteristics

Table A-2 lists the supplemental characteristics, which are not warranted but are descriptions of typical performance determined either by design or type testing.

Table A-2

		N3302A	N3303A	N3304A	N3304A-J01 Special order option	N3305A	N3306A	N3307A
Programming resolution								
Constant current mode		0.05/0.5 mA	0.02/0.2 mA	0.1/1 mA	0.1/1 mA	0.1/1 mA	0.2/2 mA	0.05/0.5 mA
Constant voltage mode		0.1/1 mV	0.4/4 mV	0.1/1 mV	0.135/1.35 mV	0.25/2.5 mV	0.1/1 mV	0.25/2.5 mV
Constant resistance mode		0.07/0.7/7/ 70 mΩ	0.82/8.2/ 82 mΩ	0.035/0.35/ 3.5/35 mΩ	0.05/0.5/5/ 50 mΩ	0.085/0.85/ 8.5/ 85 mΩ	0.0175/0.175/ 1.75/17.5 mΩ	0.17/1.7/ 17/170 mΩ
Readback resolution								
Current		0.05/0.5 mA	0.02/0.2 mA	0.1/1 mA	0.1/1 mA	0.1/1 mA	0.2/2 mA	0.05/0.5 mA
Voltage		0.1/1 mV	0.4/4 mV	0.1/1 mV	0.135/1.35 mV	0.25/2.5 mV	0.1/1 mV	0.25/2.5 mV
Programmable slew rate¹								
Current ranges	Slow band	500–25 kA/s	167–8330 A/s	1 k–50 kA/s	1 k–50 kA/s	1 k–50 kA/s	2–100 kA/s	500–25 kA/s
	Fast band ≥3 V	50 k–2.5 MA/s	16.7 k–833 kA/s	100 k–5 MA/s	100 k–5 MA/s	100 k–5 MA/s	200 k–10 MA/s	50 k–2.5 MA/s
	Fast band <3 V	50 k–250 kA/s	16.7 k–83.3 kA/s	100 k–500 kA/s	100 k–500 kA/s	100 k–500 kA/s	200 k–1 MA/s	50 k–250 kA/s
Voltage ranges	Slow band	1 k–50 kV/s	4 k–200 kV/s	1 k–50 kV/s	1.33 k–66.6 kV/s	2.5 k–125 kV/s	1 k–50 kV/s	2.5 k–125 kV/s
	Fast band ≥3 V	100 k– 500 kV/s	400 k– 2 MV/s	100 k– 500 kV/s	133 k– 666 kV/s	250 k– 1.25 MV/s	100 k– 500 kV/s	250 k– 1.25 MV/s
	Fast band <3 V	100 k–50 kV/s	400 k–200 kV/s	100 k–50 kV/s	133 k–66.6 kV/s	250 k–125 kV/s	100 k–50 kV/s	250 k–125 kV/s
Resistance range 1	Slow band	44–1125 Ω/s	540–13.5 kΩ/s	22–560 Ω/s	30–745 Ω/s	55–1400 Ω/s	11–280 Ω/s	110–2800 Ω/s
	Fast band ≥3 V	2250–34 kΩ/s	27 k–408 kΩ/s	1120–17 kΩ/s	1500–22.6 kΩ/s	2800–42.5 kΩ/s	560–8.5 kΩ/s	5600–85 kΩ/s
	Fast band <3 V	2250–3.4 kΩ/s	27 k–40.8 kΩ/s	1120–1.7 kΩ/s	1500–2.26 kΩ/s	2800–4.25 kΩ/s	560–850 Ω/s	5600–8.5 kΩ/s
Resistance range 2	Slow band	440–11.25 kΩ/s	5.4 k–135 kΩ/s	220–5600 Ω/s	300–7450 Ω/s	550–14 kΩ/s	110–2800 Ω/s	1.1 k–28 kΩ/s
	Fast band ≥3 V	22.5 k– 340 kΩ/s	270 k– 4.08 MΩ/s	11.2 k– 170 kΩ/s	15 k– 226 kΩ/s	28 k– 425 kΩ/s	5600– 85 kΩ/s	56 k–850 kΩ/s
	Fast band <3 V	22.5 k– 34 kΩ/s	270 k– 408 kΩ/s	11.2 k– 17 kΩ/s	15 k– 22.6 kΩ/s	28 k– 42.5 kΩ/s	5600– 8.5 kΩ/s	56 k– 85 kΩ/s
Resistance range 3	Slow band	4.4 k– 112.5 kΩ/s	54 k– 1.35 MΩ/s	2.2 k– 56 kΩ/s	3 k– 74.5 kΩ/s	5.5 k– 140 kΩ/s	1.1 k– 28 kΩ/s	11 k– 280 kΩ/s
	Fast band ≥3 V	225 k– 3.4 MΩ/s	2.7 M– 40.8 MΩ/s	112 k– 1.7 MΩ/s	150 k– 2.26 MΩ/s	280 k– 4.25 MΩ/s	56 k– 850 kΩ/s	560 k– 8.5 MΩ/s
	Fast band <3 V	225 k– 340 kΩ/s	2.7 M– 4.08 MΩ/s	112 k– 170 kΩ/s	150 k– 226 kΩ/s	280 k– 425 kΩ/s	56 k– 85 kΩ/s	560 k– 850 kΩ/s
Resistance range 4	Slow band	44 k– 1.125 MΩ/s	540 k– 13.5 MΩ/s	22 k– 560 kΩ/s	30 k– 745 kΩ/s	55 k– 1.4 MΩ/s	11 k– 280 kΩ/s	110 k– 2.8 MΩ/s
	Fast band ≥3 V	2.2 M– 34 MΩ/s	27 M– 408 MΩ/s	1.12 M– 17 MΩ/s	1.5 M– 22.6 MΩ/s	2.8 M– 42.5 MΩ/s	560 k– 8.5 MΩ/s	5.6 M– 85 MΩ/s
	Fast band <3 V	2.25 M– 3.4 MΩ/s	27 M– 40.8 MΩ/s	1.12 M– 1.7 MΩ/s	1.5 M– 2.26 MΩ/s	2.8 M– 4.25 MΩ/s	560 k– 850 kΩ/s	5.6 M– 8.5 MΩ/s
Programmable short								
Maximum		66 mΩ	200 mΩ	33 mΩ	33 mΩ	33 mΩ	17 mΩ	33 mΩ
Typical		40 mΩ	100 mΩ	20 mΩ	20 mΩ	25 mΩ	12 mΩ	20 mΩ
Programmable open								
		≥ 20 kΩ	≥ 80 kΩ	≥ 20 kΩ	≥ 20 kΩ	≥ 20 kΩ	≥ 20 kΩ	≥ 80 kΩ

- Slew rate bands are the ranges of programmable slew rates available. When you program a slew rate value outside the indicated bands, the electronic load will automatically adjust the slew rate to fit within the band that is closest to the programmed value. It is not necessary to specify the band, only the slew rate itself. Below 3 volts, the maximum bandwidth of the electronic load is reduced by a factor of ten to one. For example, in the current range for Model N3302A, the maximum slew rate is specified as 2.5 MA/s, below 3 volts the maximum slew rate would be 250 kA/s. Any slew rate programmed between 2.5 MA/s and 250 kA/s would produce a slew rate of 250 k/s. Slew rates programmed slower than 250 kA/s would still correctly reflect their programmed value. Note that if you are using transient mode to generate a high frequency pulse train, a reduced slew rate might cause the load to never reach the upper programmed value before beginning the transition to the lower programmed value. So even though the transient mode is still operational at lower voltages, a fast pulse train with large transitions may not be achievable.

Supplemental Characteristics

Table A-2 (continued)

		N3302A	N3303A	N3304A/ N3304A-J01	N3305A	N3306A	N3307A
Ripple and noise (20 Hz-10 MHz)							
Current (rms/peak to peak)		2 mA/ 20 mA	1 mA/ 10 mA	4 mA/ 40 mA	4 mA/ 40 mA	6 mA/ 60 mA	2 mA/ 20 mA
Voltage (rms)		5 mV rms	12 mV rms	6 mV rms ²	10 mV rms	8 mV rms	10 mV rms
External analog programming							
Voltage programming accuracy¹	0.5% +	12 mV	48 mV	12 mV	30 mV	12 mV	30 mV
Current programming accuracy¹	0.25% +	4.5 mA	1.5 mA	9 mA	9 mA	18 mA	4.5 mA
External monitor ports							
Voltage monitor accuracy	0.25% +	12 mV	48 mV	12 mV	30 mV	12 mV	30 mV
Current monitor accuracy	0.1% +	4.5 mA	1.5 mA	9 mA	9 mA	18 mA	4.5 mA

1. Applies to all ranges.

2. Ripple and noise for N3304-J01 = 8 mV rms.

Table A-3 lists the supplemental characteristics for the different mainframes

Table A-3

	N3300A	N3301A
Operating temperature range	0 °C to 55 °C	0 °C to 55 °C
Input ratings		
Operating range	100–250 VAC; 48–63 Hz	100–250 VAC; 48–63 Hz
Input current	4.2 A @ 100–127 VAC; 2.2 A @ 200–250 VAC	2.3 A @ 100–250 VAC
Input VA	440 VA	230 VA
Inrush current	38 A	18 A @ 115 VAC; 36 A @ 230 VAC

Table A-4 Measurement time

Number of samples or points	Measurement time	Additional fixed offset (in addition to measurement accuracy)
1000 samples (default)	20 ms	none
200 samples	10 ms	< 6%
100 samples	9 ms	< 10%
20 points	7 ms	< 30%
< 20 points	7 ms	> 30%

Supplemental Characteristics for All Model Numbers

Command processing time:

Average time for the output voltage to change after getting a GPIB command is 3 ms for discrete commands, 1 ms for list commands

List dwell characteristics:

Range: 0 - 10 s
Resolution: 1 ms
Accuracy: 5 ms

Transient generator:

Frequency range: 0.25 Hz - 10 kHz
Frequency accuracy: 0.5%
Duty cycle range:
3 to 97% (0.25 Hz - 1 kHz);
6 to 94% (1 kHz - 10 kHz)
Duty cycle accuracy: 1%
Pulse width: 50 μ s \pm 1% to
4 seconds \pm 1%

Analog programming bandwidth:

10 kHz rms (-3 db frequency)

Analog programming voltage:

Voltage: 0 - 10 V
Current: 0 - 10 V

Analog monitor ports:

Voltage: 0 - 10 V
Current: 0 - 10 V

DC floating voltage:

Output terminals can be floated up to \pm 300 VDC from chassis ground

Remote sensing:

5 V DC between sense and load input

Digital/Trigger inputs:

Vil = 0.9 V max at Iil = -1 mA
Vih = 3.15 V min (pull-up resistor on input)

Digital/Trigger outputs:

Vol = 0.72 V max at Iol = 1 mA
Voh = 4.4 V min at Ioh = -20 μ A

GPIB interface capabilities:

SH1, AH1, T6, L4, SR1, RL1 DT1, CD1

Software driver:

VXI*plug&play*

Regulatory compliance:

UL 61010B-1, IEC 61010-1/EN 61010-1,
CSA C22.2 No. 1010.1

Net weight:

N3300A: 13.2 kg (29 lb);
N3301A: 7.3 kg (16 lb);
N3302A, N3303A, N3304A,
N3304A-J08 or N3307A: 2.7 kg (6 lb);
N3305A or N3306A: 4.6 kg (10 lb)

Shipping weight:

N3300A: 17 kg (38 lb);
N3301A: 9.1 kg (20 lb)
N3302A, N3303A, N3304A,
N3304A-J08 or N3307A: 4.1 kg (9 lb)
N3305A or N3306A: 6.8 kg (15 lb)

Calibration interval:

One year for modules, mainframes do not require calibration

Ordering Information

N3300A & N3301A mainframes ship with product reference CD-ROM including: VXI*plug&play* drivers, user's guide, programming guide, and application notes

Module options:

Opt. A6J: Certificate of calibration
Opt. UK6: Commercial calibration
Opt. UJ1: 8 mm screw terminal connector

Chassis options:

Opt. 0L1: Printed user's guide and programming guide

Note: no service manual available for this product

Accessories

1CM020A¹ (N3300A)

Rackmount flange kit 88.1 mm H (2U) - four brackets (4U total); 1.75 inch hole spacing

1CP012A¹ (N3300A)

Rackmount flange and handle kit 88.1 mm H (2U) - four brackets (4U total); front handles

1CM001A1 (N3301A)

Rackmount flange kit 177.0 mm H (4U) - one bracket, one half-module bracket

1CM034A¹ (N3301A)

Rackmount flange kit 177.0 mm H (4U) - two flange brackets and lock link kit for mounting two units side by side. Equivalent to 1CM023A plus p/n 5061-9694 lock link kit.

E3663AC

Support rails for Keysight rack cabinets

1. Support rails or slides are required.

Keysight N3300A

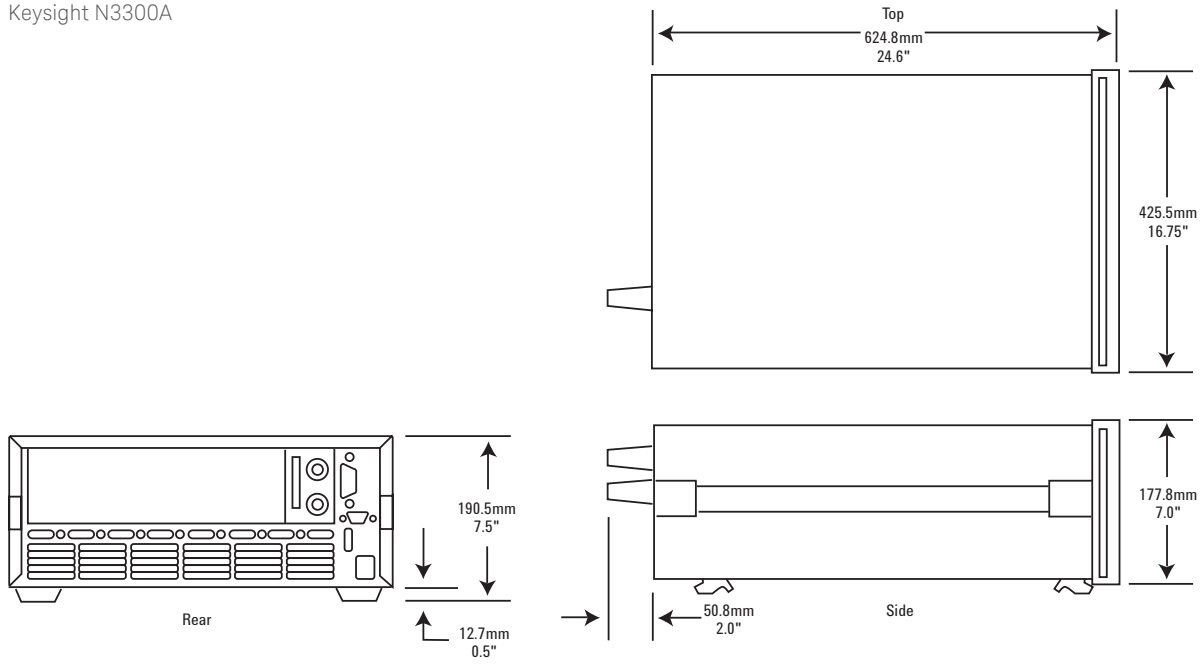

Keysight N3301A

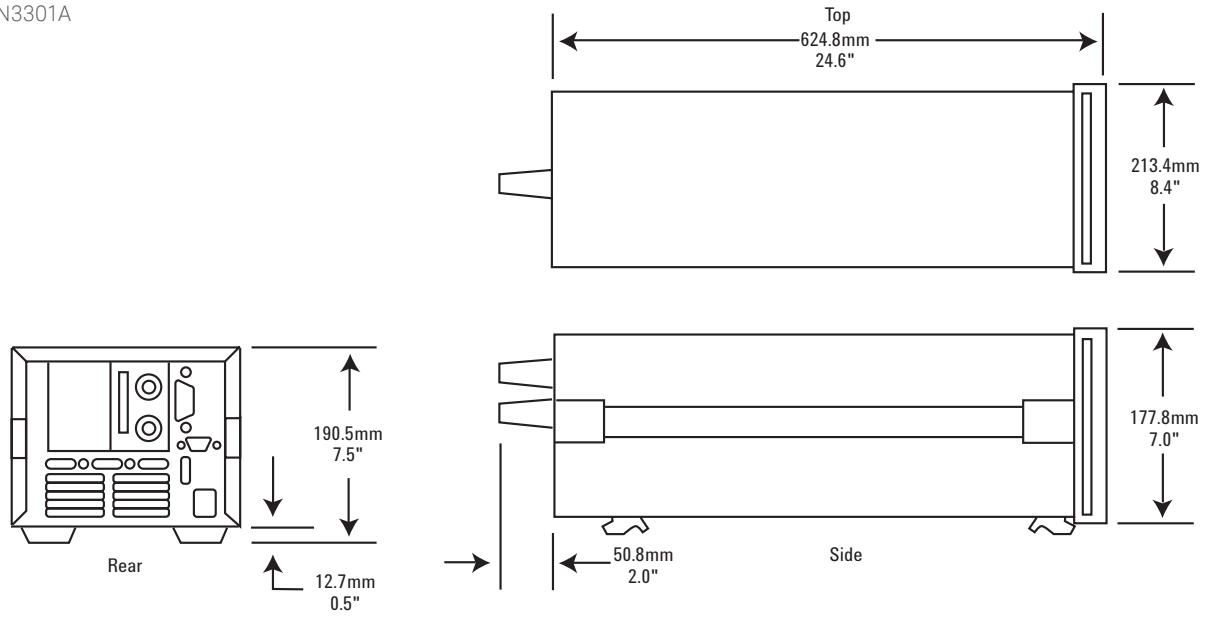

Evolving Since 1939

Our unique combination of hardware, software, services, and people can help you reach your next breakthrough. We are unlocking the future of technology.

From Hewlett-Packard to Agilent to Keysight.

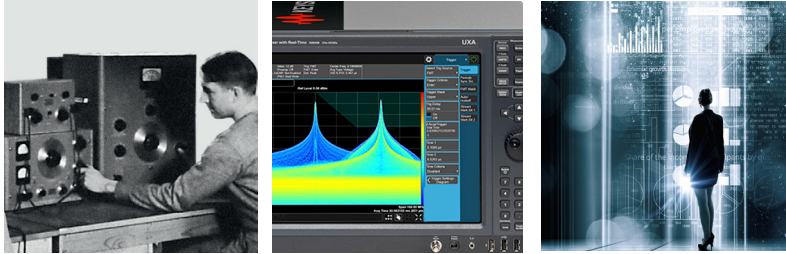

For more information on Keysight Technologies' products, applications or services, please contact your local Keysight office. The complete list is available at:

www.keysight.com/find/contactus

Americas

Canada	(877) 894 4414
Brazil	55 11 3351 7010
Mexico	001 800 254 2440
United States	(800) 829 4444

Asia Pacific

Australia	1 800 629 485
China	800 810 0189
Hong Kong	800 938 693
India	1 800 11 2626
Japan	0120 (421) 345
Korea	080 769 0800
Malaysia	1 800 888 848
Singapore	1 800 375 8100
Taiwan	0800 047 866
Other AP Countries	(65) 6375 8100

Europe & Middle East

Austria	0800 001122
Belgium	0800 58580
Finland	0800 523252
France	0805 980333
Germany	0800 6270999
Ireland	1800 832700
Israel	1 809 343051
Italy	800 599100
Luxembourg	+32 800 58580
Netherlands	0800 0233200
Russia	8800 5009286
Spain	800 000154
Sweden	0200 882255
Switzerland	0800 805353
	Opt. 1 (DE)
	Opt. 2 (FR)
	Opt. 3 (IT)
United Kingdom	0800 0260637

For other unlisted countries:

www.keysight.com/find/contactus
(BP-9-7-17)

DEKRA Certified
ISO 9001 Quality Management System

www.keysight.com/go/quality
Keysight Technologies, Inc.
DEKRA Certified ISO 9001:2015
Quality Management System

myKeysight

myKeysight

www.keysight.com/find/mykeysight

A personalized view into the information most relevant to you.

http://www.keysight.com/find/emt_product_registration

Register your products to get up-to-date product information and find warranty information.

KEYSIGHT SERVICES
Accelerate Technology Adoption.
Lower costs.

Keysight Services

www.keysight.com/find/service

Keysight Services can help from acquisition to renewal across your instrument's lifecycle. Our comprehensive service offerings—one-stop calibration, repair, asset management, technology refresh, consulting, training and more—helps you improve product quality and lower costs.

Keysight Assurance Plans

www.keysight.com/find/AssurancePlans

Up to ten years of protection and no budgetary surprises to ensure your instruments are operating to specification, so you can rely on accurate measurements.

Keysight Channel Partners

www.keysight.com/find/channelpartners

Get the best of both worlds: Keysight's measurement expertise and product breadth, combined with channel partner convenience.



This information is subject to change without notice.
© Keysight Technologies, 2017
Published in USA, December 1, 2017
5980-0232E
www.keysight.com