

**GENERAL DESCRIPTION**

The F2923 is a low insertion loss 50Ω SP2T absorptive RF Switch designed for a multitude of wireless and other RF applications. This device covers a broad frequency range from 300 kHz to 8000 MHz. In addition to providing low insertion loss, industry leading isolation at 2 GHz and excellent linearity, the F2923 also includes a patent pending constant impedance ( $K_z$ ) feature.  $K_z$  minimizes LO pulling in VCOs and reduces phase and amplitude variations in distribution networks. It is also ideal for dynamic switching/selection between two or more amplifiers while avoiding damage to upstream/downstream sensitive devices such as PAs and ADCs.

The F2923 uses a single positive supply voltage of 3.3 V supporting three states using either 3.3 V or 1.8 V control logic. An added feature includes a ModeCTL pin allowing the user to control the device with either 1-pin or 2-pin control.

**COMPETITIVE ADVANTAGE**

The F2923 provides constant impedance on all ports during transitions without compromising isolation, linearity, or insertion loss.

- ✓ Constant impedance  $K_{|z|}$  during switching transition
  - ✓ VSWR RF\_Com port 1.4:1 vs. 9:1 for Standard Switch
  - ✓ Insertion Loss = 0.48 dB\*
  - ✓ IIP3: +66 dBm\*
  - ✓ RF1/RF2 to RF\_COM Isolation = 74 dB\*
  - ✓ Extended temperature: -55 °C to +105 °C
  - ✓ Negative supply voltage not required
- \*2 GHz

**APPLICATIONS**

- Base Station 2G, 3G, 4G
- Portable Wireless
- Repeaters and E911 systems
- Digital Pre-Distortion
- Point to Point Infrastructure
- Public Safety Infrastructure
- WIMAX Receivers and Transmitters
- Military Systems, JTRS radios
- RFID handheld and portable readers
- Cable Infrastructure
- Wireless LAN
- Test / ATE Equipment

**FEATURES**

- Constant Impedance  $K_{|z|}$  during transition
- Very low insertion loss: 0.48 dB @ 2 GHz
- High Input IP3: 66 dB @ 2 GHz
- RF1/RF2 to RF\_Com Isolation: 74 dB @ 2 GHz
- 1-pin or 2-pin device control option
- Low DC current: 127 μA using 3.3 V logic
- Supply voltage: 3.3 V
- Supports 1.8 V and 3.3 V control logic
- Extended temperature: -55 °C to +105 °C
- 4 mm x 4 mm, 20-pin TQFN package
- Pin compatible with F2912

**FUNCTIONAL BLOCK DIAGRAM**

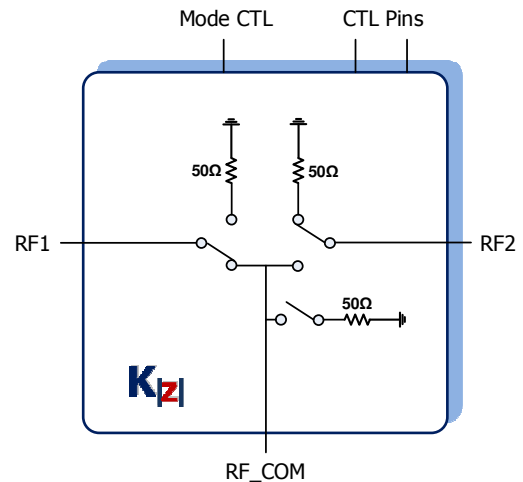

**ORDERING INFORMATION**



## ABSOLUTE MAXIMUM RATINGS

Parameter / Condition	Symbol	Min	Max	Unit
V <sub>CC</sub> to GND	V <sub>CC</sub>	-0.3	+3.9	V
CTL1, CTL2	V <sub>CNTL</sub>	-0.3	V <sub>CC</sub> + 0.3	V
ModeCTL to GND	V <sub>MODE</sub>	-0.3	V <sub>CC</sub> + 0.3	V
RF1, RF2, RF_COM	V <sub>RF</sub>	-0.3	+0.3	V
Maximum Junction Temperature	T <sub>Jmax</sub>		+140	°C
Storage Temperature Range	T <sub>ST</sub>	-65	+150	°C
Lead Temperature (soldering, 10s)	T <sub>LEAD</sub>		+260	°C
ESD Voltage– HBM (Per JESD22-A114)	V <sub>ESDHBM</sub>		Class 2	
ESD Voltage – CDM (Per JESD22-C101)	V <sub>ESDCDM</sub>		Class III	

### ABS MAX RF POWER AT 2 GHz WITH T<sub>c</sub> = +85 °C \*

RF1, RF2, RF_COM (RF1 or RF2 is connected to RF_COM, IL States)	+33dBm
RF1, RF2, RF_COM (When port is internally terminated)	+24dBm

### ABS MAX RF POWER AT 2 GHz WITH T<sub>c</sub> = +105 °C \*

RF1, RF2, RF_COM (RF1 or RF2 is connected to RF_COM, IL States)	+33dBm
RF1, RF2, RF_COM (When port is internally terminated)	+21dBm

\* Temperature of exposed paddle

*Stresses above those listed above may cause permanent damage to the device. Functional operation of the device at these or any other conditions above those indicated in the operational section of this specification is not implied. Exposure to absolute maximum rating conditions for extended periods may affect device reliability.*

## PACKAGE THERMAL AND MOISTURE CHARACTERISTICS

θ <sub>JA</sub> (Junction – Ambient)	60 °C/W
θ <sub>JC</sub> (Junction – Case) The Case is defined as the exposed paddle	3.9 °C/W
Moisture Sensitivity Rating (Per J-STD-020)	MSL1

**F2923 RECOMMENDED OPERATING CONDITIONS**

Parameter	Symbol	Conditions	Min	Typ	Max	Units
Supply Voltage	$V_{CC}$		3.1		3.5	V
Operating Temperature Range	$T_{CASE}$	Case Temperature	-55		+105	°C
RF Frequency Range	$F_{RF}$		0.3		8000	MHz
RF Continuous Input Power (CW) <sup>1</sup>	$P_{RF}$	Selected Port (I.L. State)			27	dBm
		Unselected Port <sup>2</sup> (Term State)			18	
RF1 Port Impedance	$Z_{RF1}$			50		Ω
RF2 Port Impedance	$Z_{RF2}$			50		
RF_COM Port Impedance	$Z_{RF\_COM}$			50		

Note 1– See Figure 1 below for RF power handling levels for various conditions.

Note 2– States 1, 2, or 3.

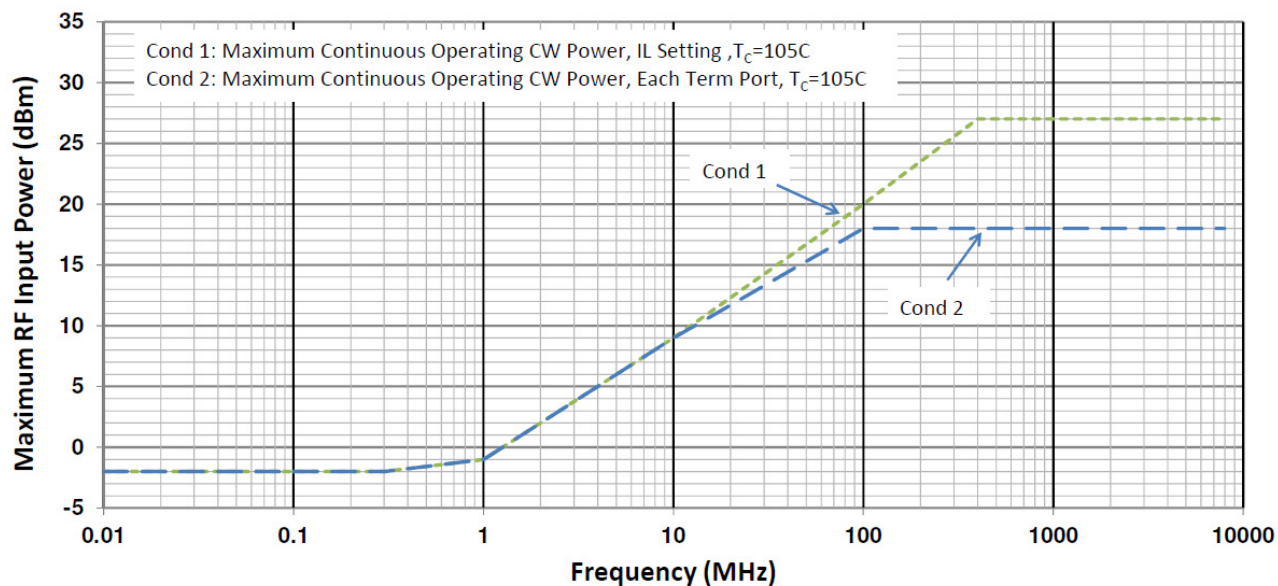

**FIGURE 1: MAXIMUM OPERATING RF INPUT POWER VS. RF FREQUENCY**

## F2923 SPECIFICATION

Typical Application Circuit,  $V_{CC} = +3.3\text{ V}$ ,  $T_C = +25\text{ }^\circ\text{C}$ ,  $F_{RF} = 2\text{ GHz}$ , input power = 0 dBm unless otherwise stated. PCB board trace and connector losses are de-embedded unless otherwise noted.

Parameter	Symbol	Conditions	Min	Typ	Max	Units
Logic Input High Threshold	$V_{IH}$	CTL1 and CTL2 pins	<b>1.1</b>		<b>3.6</b>	V
Logic Input Low Threshold	$V_{IL}$	CTL1 and CTL2 pins			<b>0.6</b>	V
ModeCTL Input High				$V_{CC}$		V
ModeCTL Input Low				GND		V
Logic Current	$I_{IH}, I_{IL}$	CTL1, CTL2, ModeCTL pins			<b>1000</b>	nA
DC Current ( $V_{CC}$ )	$I_{CC}$	State 2 or State 3		127	<b>150</b>	$\mu\text{A}$
VSWR during transition	$VSWR_T$	RF1/RF2 to RF_COM		1.4:1		-
Insertion Loss RF1/RF2 to RF_COM (State 2 or 3)	IL	RF = 1 GHz		0.43		dB
		RF = 2 GHz		0.48	<b>0.8<sup>1</sup></b>	
		RF = 4 GHz		0.63		
		RF = 6 GHz		0.89		
		RF = 8 GHz		1.12		
Isolation RF1 / RF2 to RF_COM (State 2 or 3)	ISO1	RF = 1 GHz		77		dB
		RF = 2 GHz	<b>71<sup>2</sup></b>	74		
		RF = 4 GHz		51		
		RF = 6 GHz		40		
		RF = 8 GHz		37		
Isolation RF1 to RF2 (State 2 or 3)	ISO2	RF = 1 GHz		73		dB
		RF = 2 GHz	<b>61</b>	63		
		RF = 4 GHz		51		
		RF = 6 GHz		35		
		RF = 8 GHz		29		
Return Loss RF_COM (State 1)	RL1	RF = 1 GHz		23.8		dB
		RF = 2 GHz		25.2		
		RF = 4 GHz		26.7		
		RF = 6 GHz		18.4		
		RF = 8 GHz		16.6		
Return Loss RF_COM (State 2 or 3)	RL2	RF = 1 GHz		29.6		dB
		RF = 2 GHz		25.4		
		RF = 4 GHz		26.1		
		RF = 6 GHz		17.6		
		RF = 8 GHz		14.1		

Note 1– Items in min/max columns in **bold italics** are Guaranteed by Test.

Note 2– Items in min/max columns NOT in bold italics are Guaranteed by Design Characterization.

## F2923 SPECIFICATION (CONT.)

Typical Application Circuit,  $V_{CC} = +3.3\text{ V}$ ,  $T_C = +25\text{ }^\circ\text{C}$ ,  $F_{RF} = 2\text{ GHz}$ , input power = 0 dBm unless otherwise stated. PCB board trace and connector losses are de-embedded unless otherwise noted.

Parameter	Symbol	Conditions	Min	Typ	Max	Units
Return Loss RF1, RF2 (State 1)	RL3	RF = 1 GHz		22.6		dB
		RF = 2 GHz		23.4		
		RF = 4 GHz		25.2		
		RF = 6 GHz		19.9		
		RF = 8 GHz		11.2		
Return Loss RF1, RF2 when selected (State 2 or 3)	RL4	RF = 1 GHz		33.7		dB
		RF = 2 GHz		28.4		
		RF = 4 GHz		28.0		
		RF = 6 GHz		17.7		
		RF = 8 GHz		15.0		
Input IP2 RF1 / RF2 (State 2 or 3)	IIP2	$P_{IN} = +13\text{ dBm}$ per tone	RF = 1 GHz		116	dBm
			RF = 2 GHz		106	
			RF = 3 GHz		105	
Input IP3 RF1 / RF2 (State 2 or 3)	IIP3	$P_{IN} = +13\text{ dBm}$ per tone	RF = 1 GHz		66	dBm
			RF = 2 GHz		66	
			RF = 3 GHz		65	
			RF = 4 GHz		65	
			RF = 6 GHz		52	
Input 1dB compression RF1 / RF2 (State 2 or 3) <sup>3</sup>	IP1dB	RF = 2 GHz		32		dBm
Switching Time <sup>4</sup>	$T_{SW}$	50% control to 90% RF		0.6		$\mu\text{s}$
		50% control to 10% RF		0.5		
		50% control to RF settled to within +/- 0.1 dB of I.L. value.		0.675		
Maximum Switching Rate	$SW_{RATE}$			25		kHz
Maximum spurious level on any RF port <sup>5</sup>	$Spur_{MAX}$	RF ports terminated into 50 $\Omega$		-137		dBm

Note 1– Items in min/max columns in ***bold italics*** are Guaranteed by Test.

Note 2– Items in min/max columns NOT in bold italics are Guaranteed by Design Characterization.

Note 3– The input 1dB compression point is a linearity figure of merit. Refer to Figure 1 above and Recommended Operating Conditions sections for the maximum RF input powers.

Note 4–  $F_{RF} = 2\text{ GHz}$ .

Note 5– Spurious due to on-chip negative voltage generator. Typical generator fundamental frequency is 2.2 MHz.

Table 1 includes 3 states and provides the truth table for 2-pin control input.

**Table 1 - Switch Control Truth Table for 3 states using 2 control pins; pin 16 and pin 17**

State	Control pin input		RF1, RF2 input / output	
	CTL1 (Pin 17)	CTL2 (Pin 16)	RF1 to RF Com	RF2 to RF Com
1	Low	Low	OFF	OFF
2	Low	High	OFF	ON
3	High	Low	ON	OFF
4	High	High	N/A	N/A

Table 2 includes 2 states and provides the truth table for 1-pin control input.

**Table 2 - Switch Control Truth Table for 2 states using a single control pin 16**

State	Control pin input		RF1, RF2 input / output	
	CTL1 (Pin 17)	CTL2 (Pin 16)	RF1 to RF Com	RF2 to RF Com
2	don't care	High	OFF	ON
3	don't care	Low	ON	OFF

Table 3 provides the truth table for selecting the use of either 1 or 2 control pins.

**Table 3 - Mode Control (pin 19) Truth table to use either 1 or 2 control pins**

Pin Control Mode	ModeCTL (Pin 19)
2-pin control: CTL1 and CTL2	GND
1-pin control: CTL2	VCC

Notes:

1. When RF1 and RF2 ports are both open (State 1), all 3 RF ports are terminated to an internal 50  $\Omega$  termination resistor.
2. When RF1 or RF2 port is open (State 2 or State 3 OFF condition), the open port is connected to an internal 50 $\Omega$  termination resistor.
3. When RF1 or RF2 port is closed (State 2 or State 3 ON condition), the closed port is connected to the RF\_COM port.

## TYPICAL OPERATING CURVE CONDITIONS

Unless otherwise noted, the following conditions apply:

- EVKit loss de-embedded for only insertion loss plots.
- Vcc = 3.3 V
- $F_{RF} = 2$  GHz
- $T_{AMB} = 25$  °C
- Small signal parameters measured with  $P_{IN} = 0$ dBm.
- Two tone tests  $P_{IN} = +13$  dBm/tone with 50 MHz tone spacing.

TYPICAL OPERATING CONDITIONS (- 1 -)

Insertion Loss vs. Temperature

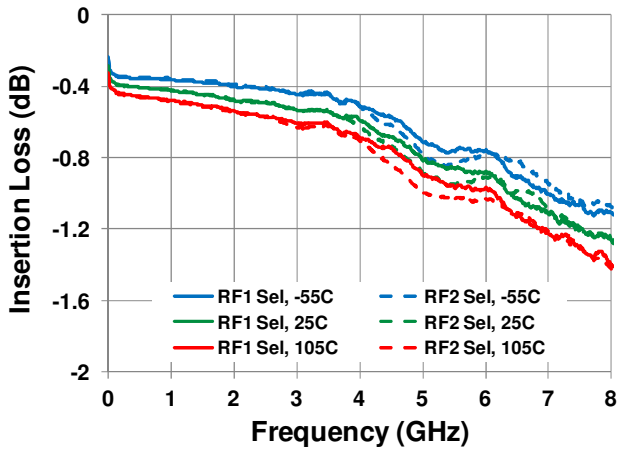

Insertion Loss vs. Voltage

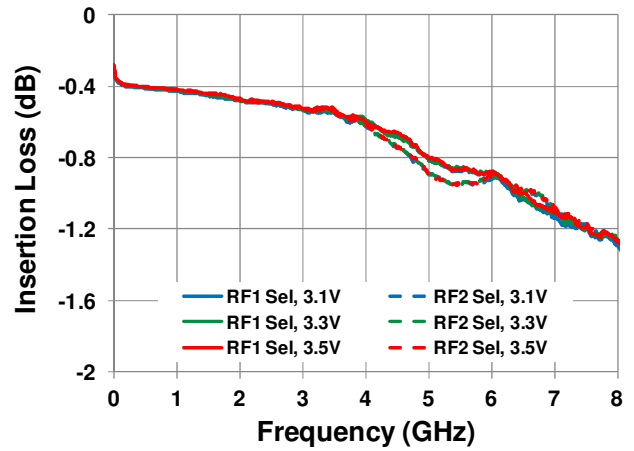

Isolation vs. Temp [RF\_COM → RF1 / RF2]

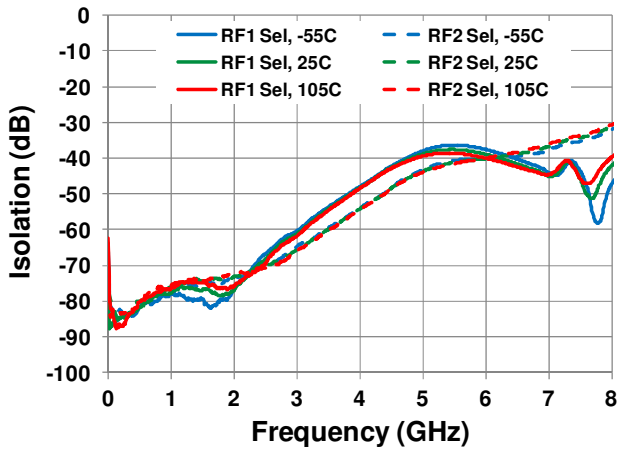

Isolation vs. Voltage [RF\_COM → RF1 / RF2]

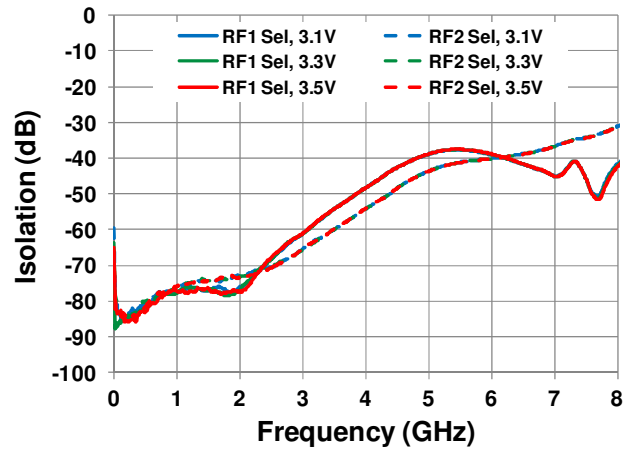

Isolation vs. Temp [RF1 → RF2, RF2 → RF1]

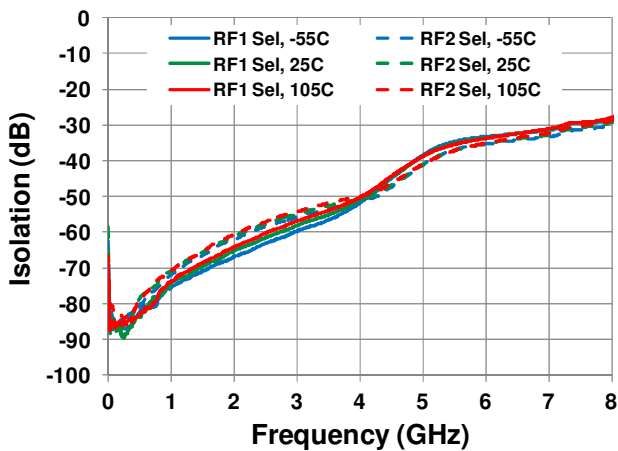

Isolation vs. Voltage [RF1 → RF2, RF2 → RF1]

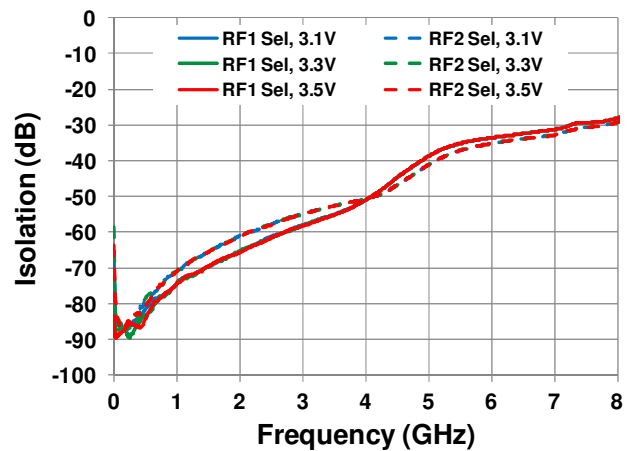

TYPICAL OPERATING CONDITIONS (- 2 -)

RF1 Return Loss vs. Temperature

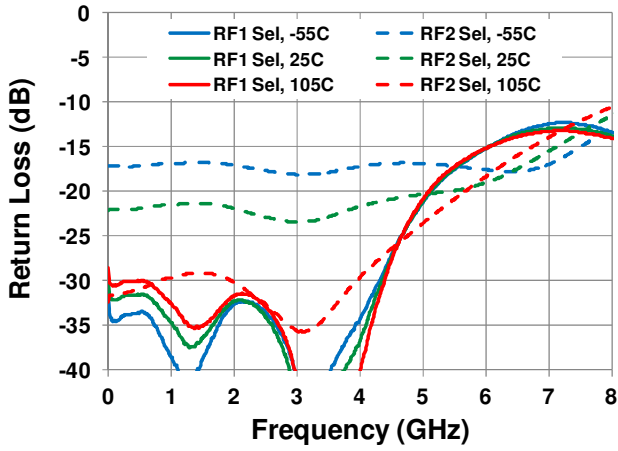

RF1 Return Loss vs. Voltage

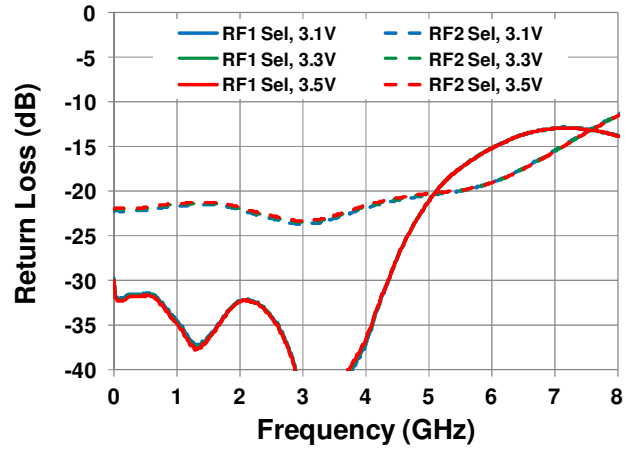

RF2 Return Loss vs. Temperature

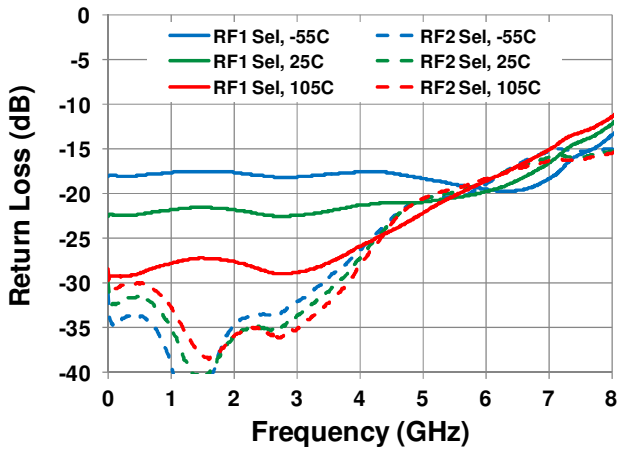

RF2 Return Loss vs. Voltage

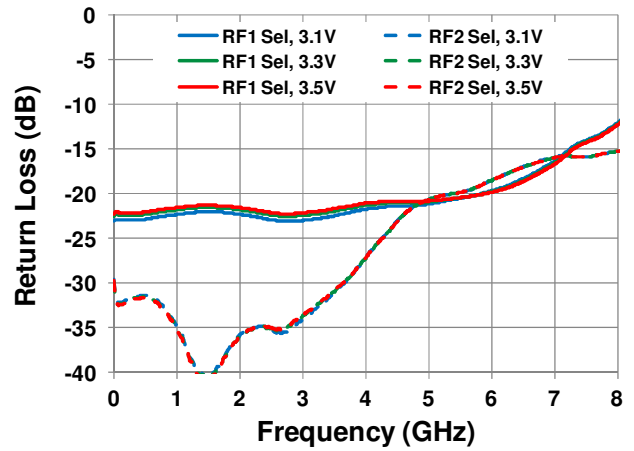

RF\_COM Return Loss vs. Temperature

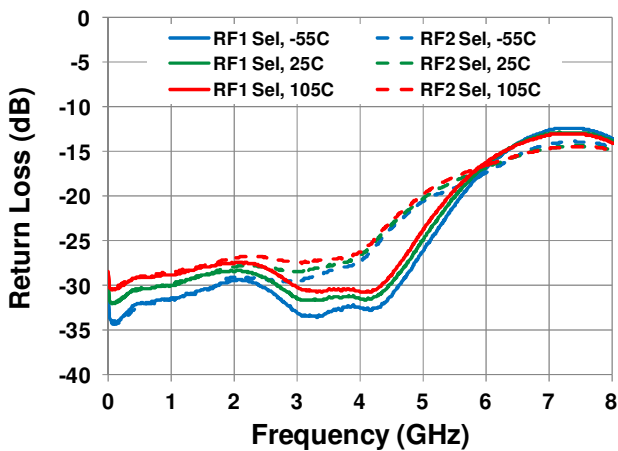

RF\_COM Return Loss vs. Voltage

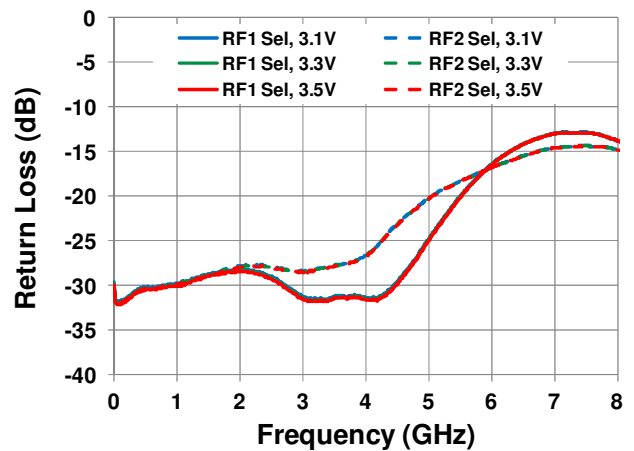



TYPICAL OPERATING CONDITIONS (- 3 -)

Isolation vs. Temp [All Off State, RF\_COM Driven]

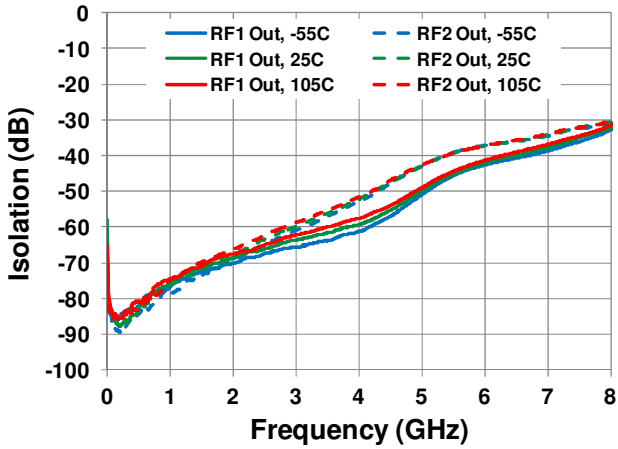

Isolation vs. Voltage [All Off State, RF\_COM Driven]

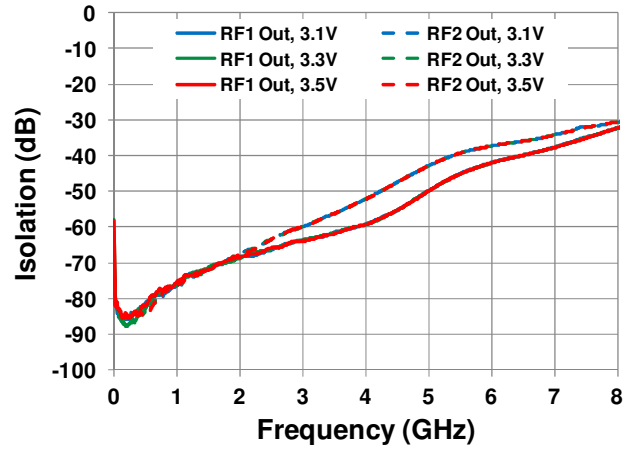

RF\_COM Return Loss [All Off State] vs. Temp

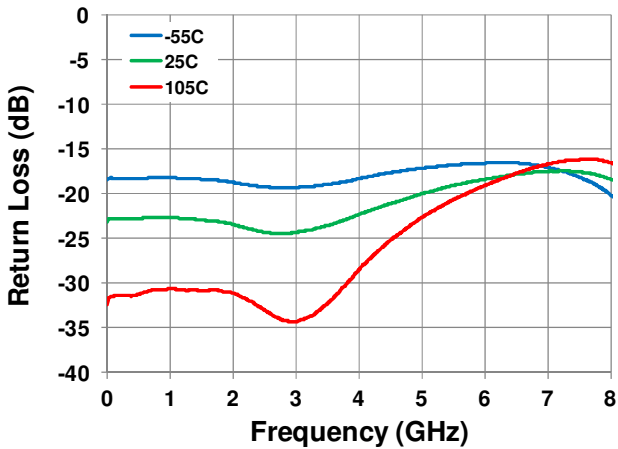

RF\_COM Return Loss [All Off State] vs. Voltage

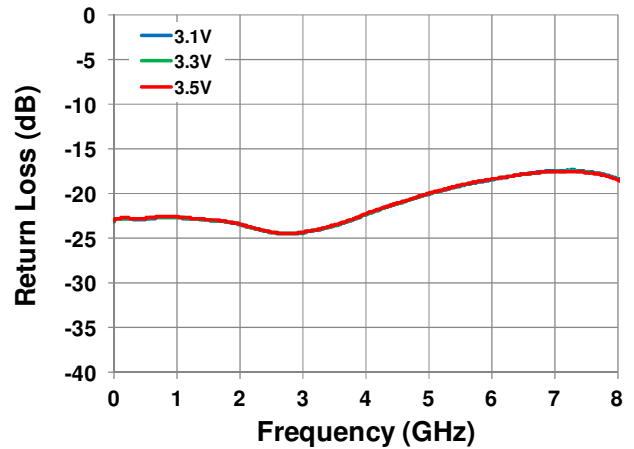

Return Loss (During Switching) vs. Time

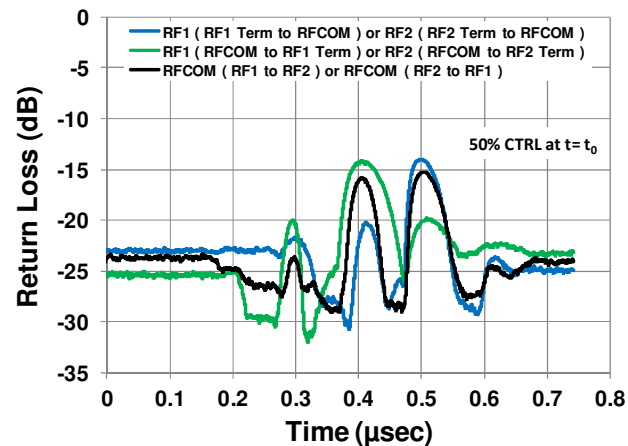

VSWR (During Switching) vs. Time

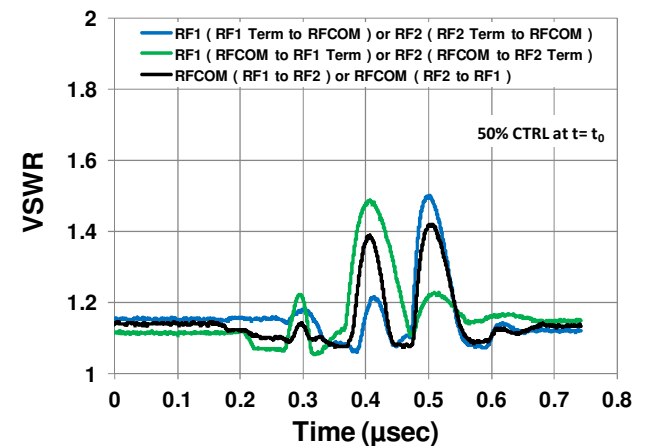

TYPICAL OPERATING CONDITIONS (- 4 -)

Switching Time  $T_c=25C$  [RF\_COM Driven, RF1 to RF2]

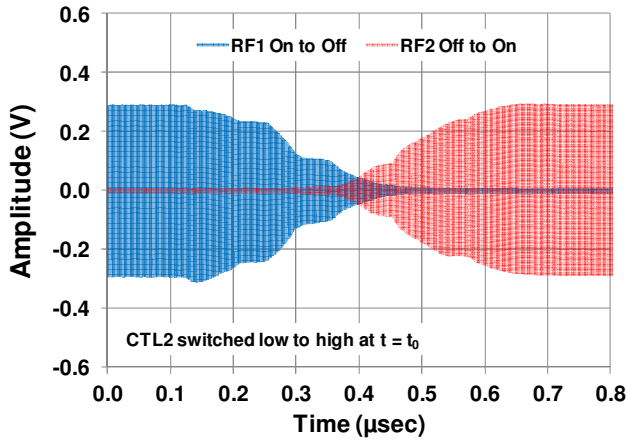

Switching Time  $T_c=25C$  [RF\_COM Driven, RF2 to RF1]

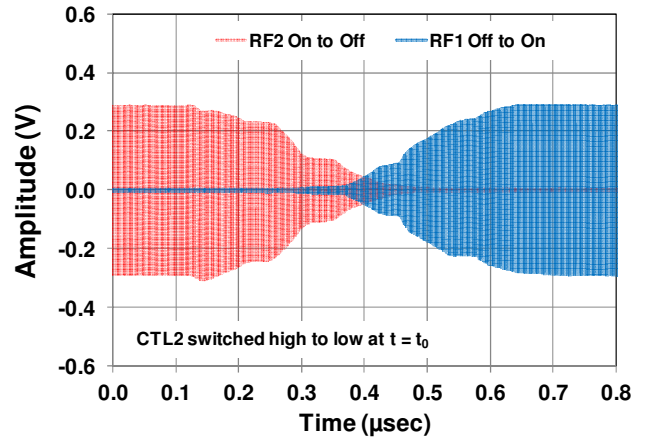

Switching Time  $T_c=-40C$  [RF\_COM Driven, RF1 to RF2]

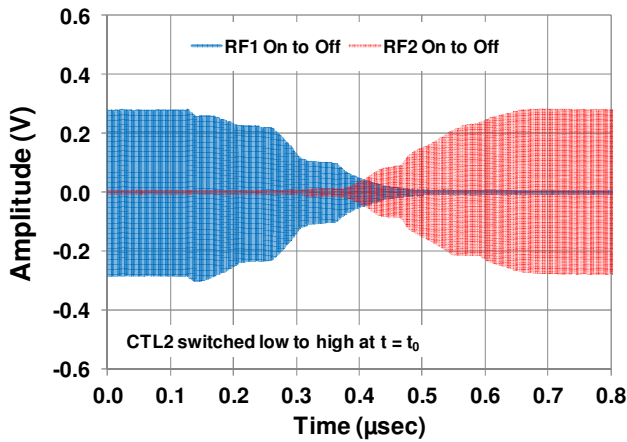

Switching Time  $T_c=-40C$  [RF\_COM Driven, RF2 to RF1]

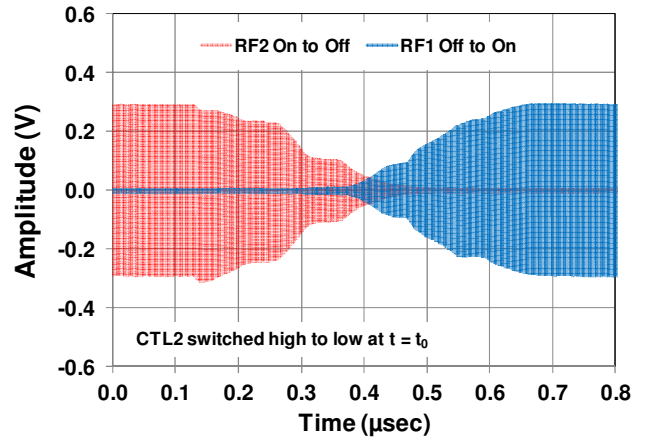

Compression [1 GHz, 2 GHz, RF1, RF2]

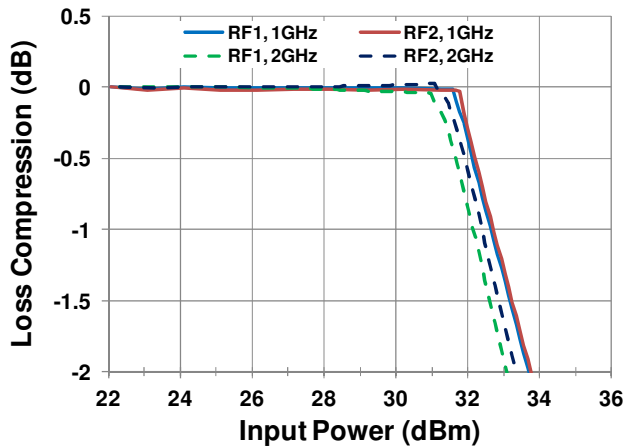

Input IP3 [1 GHz]

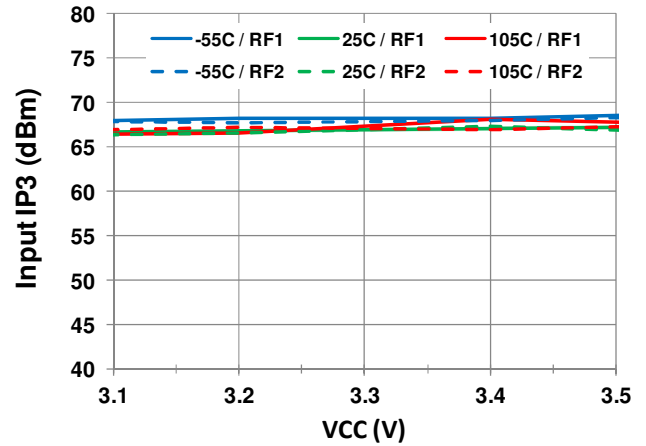

TYPICAL OPERATING CONDITIONS (- 5 -)

Input IP3 [2 GHz]

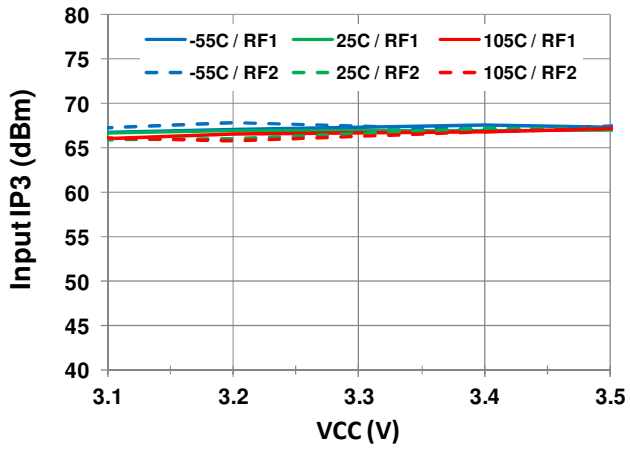

Input IP3 [3 GHz]

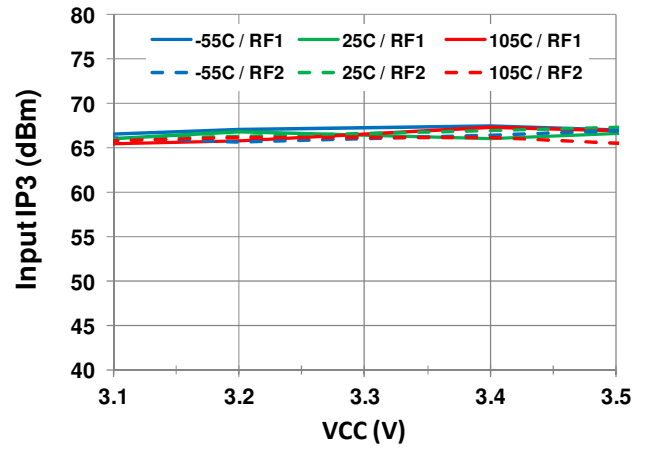

PACKAGE DRAWING

(4 mm x 4 mm 20-pin TQFN), NCG20

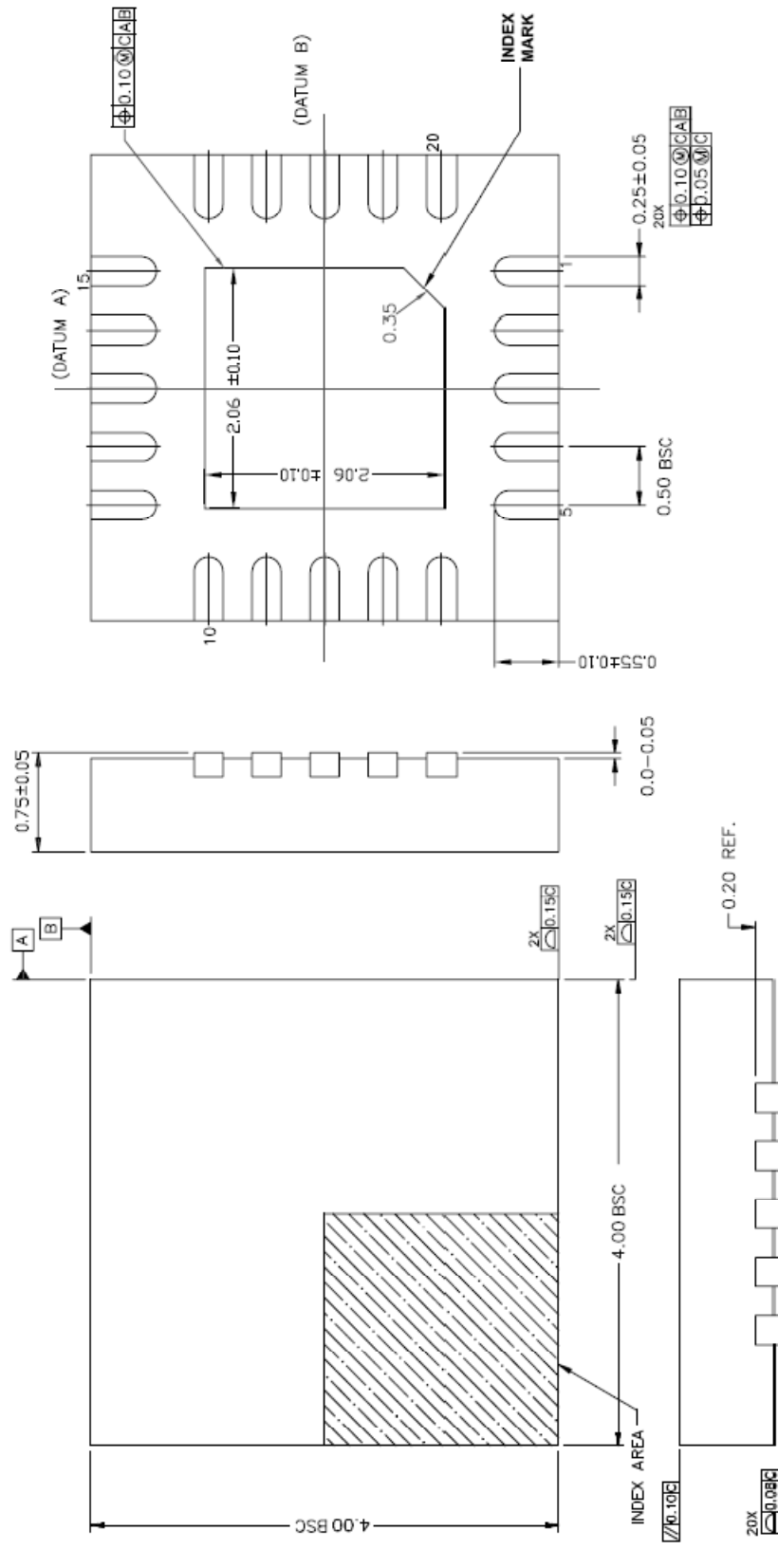

LAND PATTERN DIMENSION

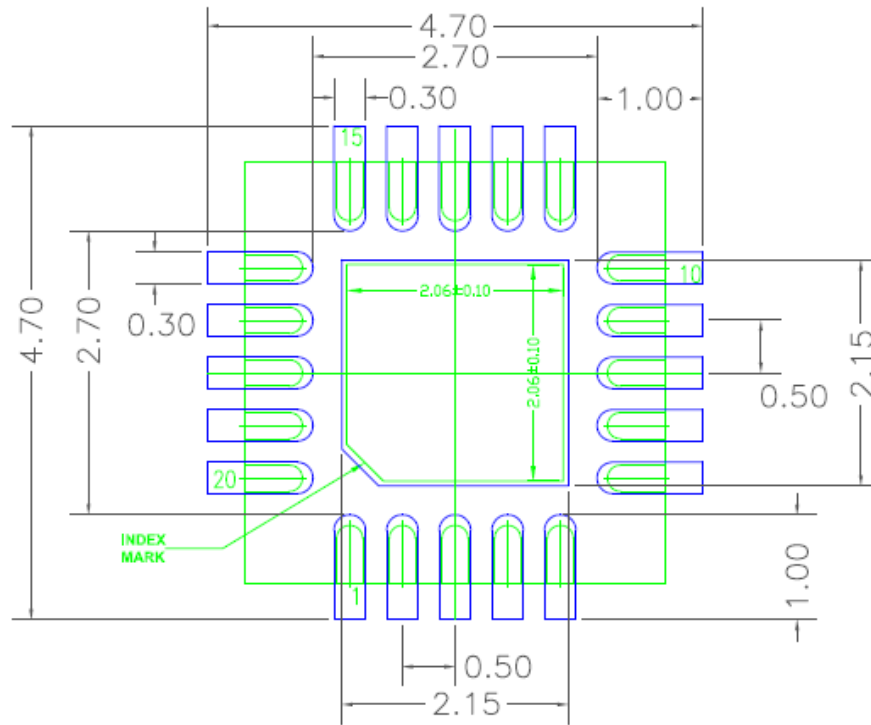

RECOMMENDED LAND PATTERN DIMENSION

NOTES:

1. ALL DIMENSION ARE IN mm. ANGLES IN DEGREES.
2. TOP DOWN VIEW. AS VIEWED ON PCB.
3. COMPONENT OUTLINE SHOW FOR REFERENCE IN GREEN.
4. LAND PATTERN IN BLUE. NSMD PATTERN ASSUMED.
5. LAND PATTERN RECOMMENDATION PER IPC-7351B GENERIC REQUIREMENT FOR SURFACE MOUNT DESIGN AND LAND PATTERN.

**PIN DIAGRAM**

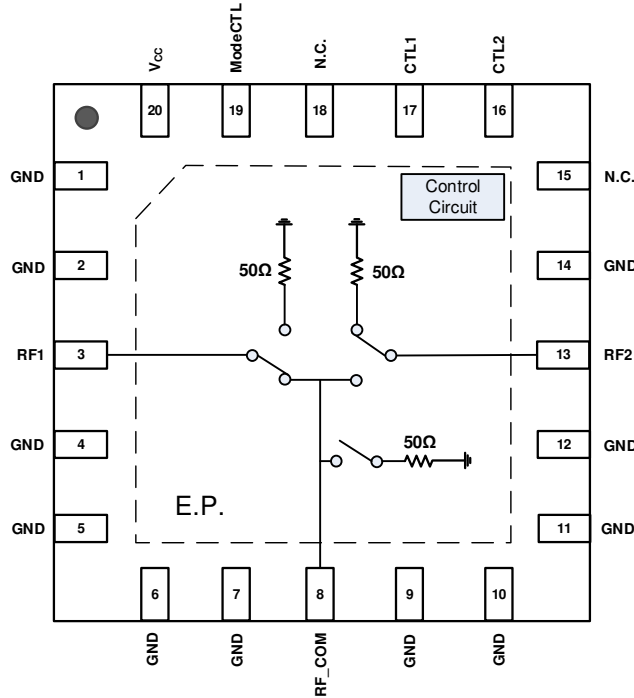

**PIN DESCRIPTION**

Pin	Name	Function
1, 2, 4, 5, 6, 7, 9, 10, 11, 12, 14	GND	Ground these pins.
3	RF1	RF1 Port. Matched to 50Ω. If this pin is not 0V DC, then an external coupling capacitor must be used.
8	RF_COM	RF Common Port. Matched to 50Ω. If this pin is not 0V DC, then an external coupling capacitor must be used.
13	RF2	RF2 Port. Matched to 50Ω. If this pin is not 0V DC, then an external coupling capacitor must be used.
15	N.C.	No internal connection. This pin can be left open or connected to ground.
16	CTL2	Control 2 – See Table 1 and Table 2 Switch Control Truth Tables for proper logic setting.
17	CTL1	Control 1 – See Table 1 and Table 2 Switch Control Truth Tables for proper logic setting.
18	N.C.	No internal connection.
19	ModeCTL	Mode Control – See Table 3 Mode Control Truth Table. Apply VCC to select 1-pin control or GND for 2-pin control.
20	Vcc	Power Supply. Bypass to GND with capacitors shown in the Typical Application Circuit as close as possible to pin.
21	— EP	Exposed Pad. Internally connected to GND. Solder this exposed pad to a PCB pad that uses multiple ground vias to provide heat transfer out of the device into the PCB ground planes. These multiple ground vias are also required to achieve the specified RF performance.

## APPLICATIONS INFORMATION

### Default Start-up

Control pins include no internal pull-down resistors to logic LOW or pull-up resistors to logic HIGH. Upon start-up, all control pins should be set to logic LOW (0) thereby enabling 2-pin switch control, opening both RF1 and RF2 paths, and setting logic control voltage to 3.3 V (see above tables for LOW logic states).

### Power Supplies

A common VCC power supply should be used for all pins requiring DC power. All supply pins should be bypassed with external capacitors to minimize noise and fast transients. Supply noise can degrade noise figure and fast transients can trigger ESD clamps and cause them to fail. Supply voltage change or transients should have a slew rate smaller than  $1 \text{ V} / 20 \mu\text{s}$ . In addition, all control pins should remain at 0 V ( $\pm 0.3 \text{ V}$ ) while the supply voltage ramps or while it returns to zero.

### Control Pin Interface

If control signal integrity is a concern and clean signals cannot be guaranteed due to overshoot, undershoot, ringing, etc., the following circuit at the input of each control pin is recommended. This applies to control pins 16, 17, and 19 as shown below.

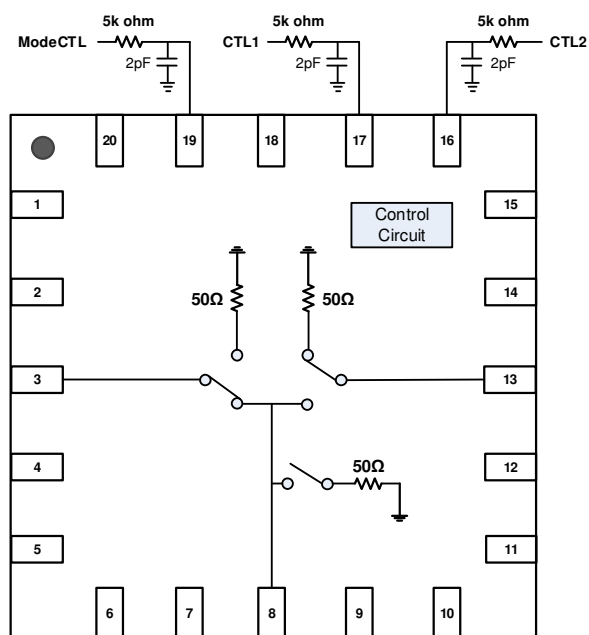

EVKIT PICTURE

Top View

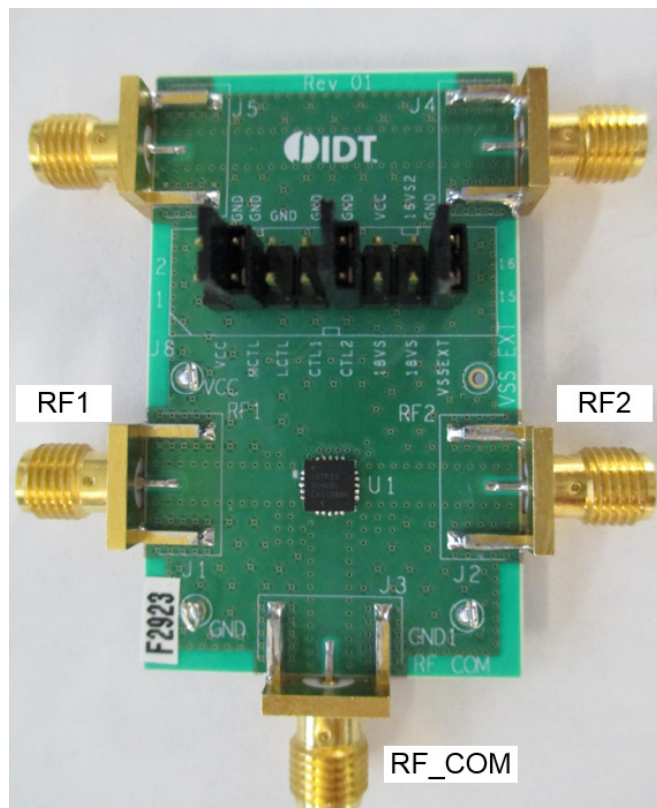

Bottom View

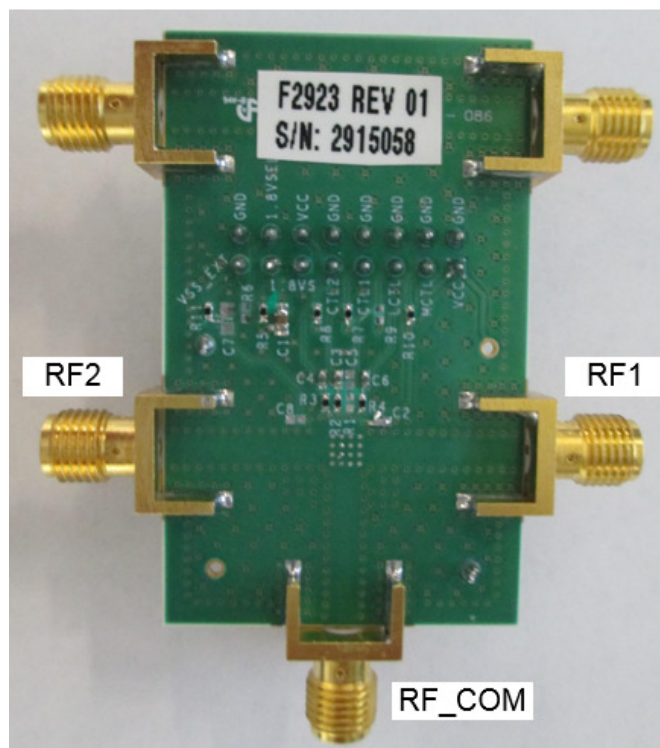



EVKIT / APPLICATIONS CIRCUIT

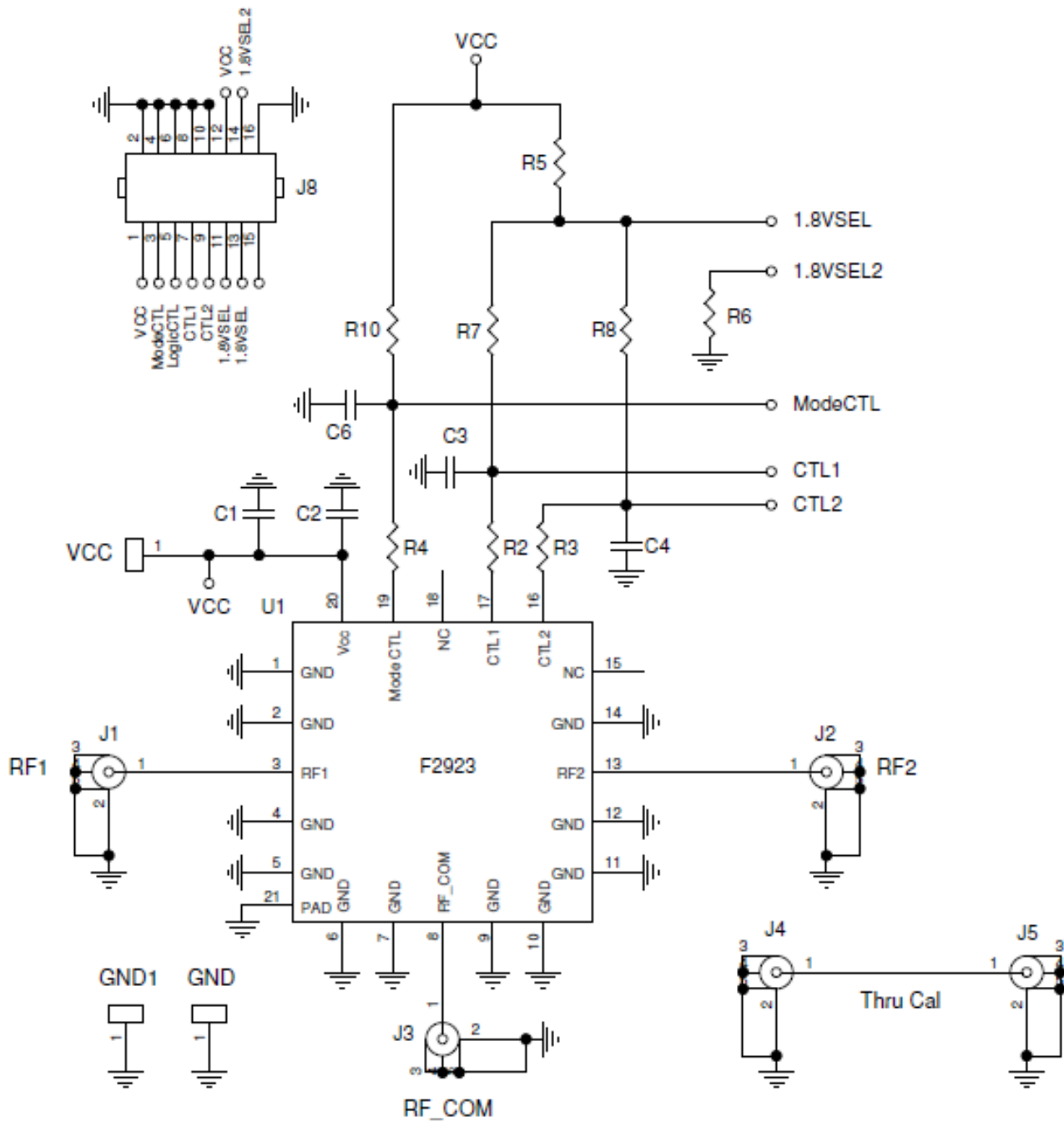

## EVKIT BOM

Part Reference	QTY	DESCRIPTION	Mfr. Part #	Mfr.
C1	1	100 nF ±10%, 50V, X7R Ceramic Capacitor (0603)	GRM188R71H104K	Murata
C2	1	1000 pF ±5%, 50V, C0G, Ceramic Capacitor (0402)	GRM1555C1H102J	Murata
C3, C4, C6	3	100 pF ±5%, 50V, C0G, Ceramic Capacitor (0402)	GRM1555C1H101J	Murata
R2, R3, R4, R5	4	0 Ω, 1/10W, Resistor (0402)	ERJ-2GE0R00X	Panasonic
R6	0	Not Installed (0402)		
R7, R8, R10	3	100k Ω ±1%, 1/10W, Resistor (0402)	ERJ-2RKF1003X	Panasonic
J1-J5	5	Edge Launch SMA (0.375 inch pitch ground tabs)	142-0701-851	Emerson Johnson
J8	1	CONN HEADER VERT DBL 8 X 2 POS GOLD	67997-116HLF	FCI
VCC, GND, GND1	3	Test Point	5021	Keystone Electronics
U1	1	SP2T Switch 4 mm x 4 mm QFN20-EP	F2923NCGI	IDT
	1	Printed Circuit Board	F2923 EVKIT Rev 01	IDT

## TOP MARKINGS

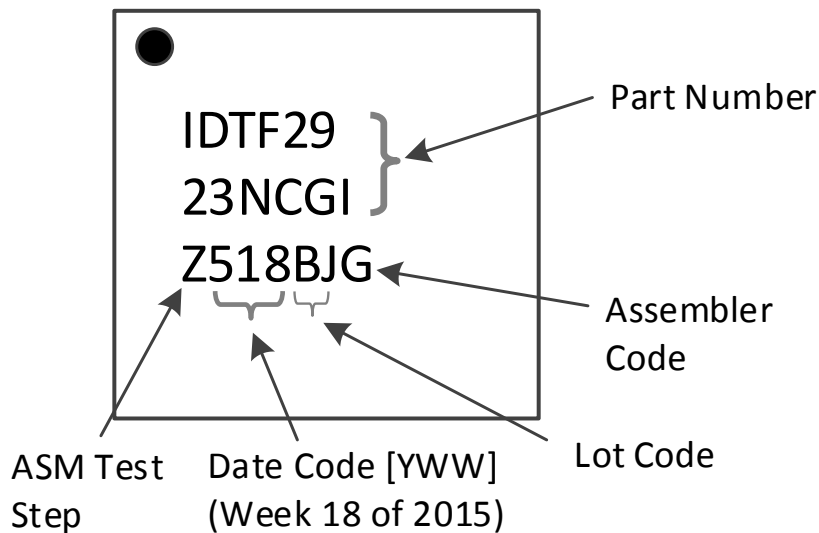

## **EVKIT OPERATION**

### **PCB RF Connectors**

The F2923 EVkit is a thin multilayer board (0.032" total thickness) designed using Rogers' 4350 high RF performance material. Since this substrate is not as rigid as standard FR4, one must take care when making connections to the board to avoid physically damaging the board. It is suggested that the body of the connector be restrained while tightening the RF connectors so to not put stress on the PCB material.

### **External Supply Setup**

Set up a VCC power supply in the voltage range of 3.1 V to 3.5 V and disable the power supply output.

### **Logic Control Setup**

#### **Using the EVKIT to manually set the Control Logic:**

To setup the part for two pin logic control connect a 2-pin shunt from pin 3 (ModeCTL) to pin 4 (GND) on connector J8.

For one pin logic control leave J8 pin 3 open. An on-board pull-up resistor R10 will connect the ModeCTL pin to Vcc to provide the logic high for one pin control.

The PCB includes 2 pull-up resistors (R7, R8) to Vcc to provide a logic high for CTL1 and CTL2 respectively. Installing a 2-pin shunt from pin 7 (CTL1) to pin 8 (GND) of J8 will provide a logic low for manual control of the CTL1 pin. Placing a 2-pin shunt from pin 9 (CTL2) to pin 10 (GND) of J8 will result in a logic low for the CTL2 pin. See Tables 1, 2 and 3 for control details.

Resistor R6 along with the 1.8VSEL, 1.8VSEL2, and LogicCTL pins are not used on the F2923 EVKIT.

#### **Using External Control Logic:**

To setup the part for two pin logic control connect a 2-pin shunt from pin 3 (ModeCTL) to pin 4 (GND) on connector J8.

For one pin control leave pin 3 (ModeCTL) of J8 open. In this configuration the ModeCTL pin will be pulled up to Vcc on the PCB through resistor R10.

### **Turn on Procedure**

Setup the supplies and Eval Board as noted in the **External Supply Setup** and **Logic Control Setup** sections above.

Connect the preset/ disabled VCC power supply to the VCC and GND loops on the PCB. If controlling CTL1 and CTL2 with external logic then set these to logic low.

Enable the VCC supply.

Set the desired logic setting using CTL1, and CTL2 Table 1 or Table 2 setting. Note that external control logic should not be applied without VCC being applied first.

For manual logic control the J8 connector CTL1 and CTL2 pins can be grounded to a neighboring ground for a logic low or left open for a logic high.

### **Turn off Procedure**

If using external control logic for CTL1, CTL2 then set them to a logic low. Disable the VCC supply.

**REVISION HISTORY SHEET**

<b>Rev</b>	<b>Date</b>	<b>Page</b>	<b>Description of Change</b>
0	2015-Nov-9		Initial Release



## IMPORTANT NOTICE AND DISCLAIMER

RENESAS ELECTRONICS CORPORATION AND ITS SUBSIDIARIES (“RENESAS”) PROVIDES TECHNICAL SPECIFICATIONS AND RELIABILITY DATA (INCLUDING DATASHEETS), DESIGN RESOURCES (INCLUDING REFERENCE DESIGNS), APPLICATION OR OTHER DESIGN ADVICE, WEB TOOLS, SAFETY INFORMATION, AND OTHER RESOURCES “AS IS” AND WITH ALL FAULTS, AND DISCLAIMS ALL WARRANTIES, EXPRESS OR IMPLIED, INCLUDING, WITHOUT LIMITATION, ANY IMPLIED WARRANTIES OF MERCHANTABILITY, FITNESS FOR A PARTICULAR PURPOSE, OR NON-INFRINGEMENT OF THIRD PARTY INTELLECTUAL PROPERTY RIGHTS.

These resources are intended for developers skilled in the art designing with Renesas products. You are solely responsible for (1) selecting the appropriate products for your application, (2) designing, validating, and testing your application, and (3) ensuring your application meets applicable standards, and any other safety, security, or other requirements. These resources are subject to change without notice. Renesas grants you permission to use these resources only for development of an application that uses Renesas products. Other reproduction or use of these resources is strictly prohibited. No license is granted to any other Renesas intellectual property or to any third party intellectual property. Renesas disclaims responsibility for, and you will fully indemnify Renesas and its representatives against, any claims, damages, costs, losses, or liabilities arising out of your use of these resources. Renesas' products are provided only subject to Renesas' Terms and Conditions of Sale or other applicable terms agreed to in writing. No use of any Renesas resources expands or otherwise alters any applicable warranties or warranty disclaimers for these products.

(Rev.1.0 Mar 2020)

### Corporate Headquarters

TOYOSU FORESIA, 3-2-24 Toyosu,  
Koto-ku, Tokyo 135-0061, Japan  
[www.renesas.com](http://www.renesas.com)

### Contact Information

For further information on a product, technology, the most up-to-date version of a document, or your nearest sales office, please visit:  
[www.renesas.com/contact/](http://www.renesas.com/contact/)

### Trademarks

Renesas and the Renesas logo are trademarks of Renesas Electronics Corporation. All trademarks and registered trademarks are the property of their respective owners.