

A768, Polymer Aluminum, 68 uF, 20%, 40 VDC, -55/+125°C

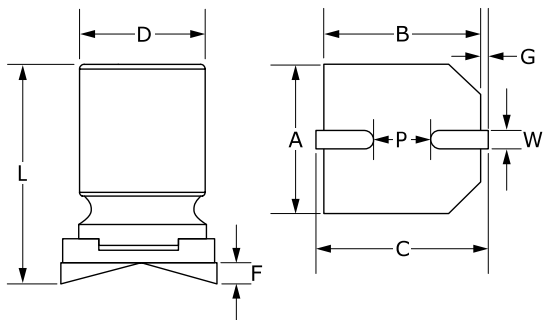

General Information	
Series:	A768
Dielectric:	Polymer Aluminum
Style:	SMD Can
Description:	Surface Mount, Polymer Aluminum
RoHS:	Yes
Lead:	V-Chip
AEC-Q200:	No
Halogen Free:	Yes

Dimensions	
D	8mm +/-0.5mm
L	6.7mm +/-0.3mm
W	0.8 - 1.1mm
F	0.2mm MAX
A	8.3mm +/-0.2mm
B	8.3mm +/-0.2mm
C	9mm +/-0.2mm
G	0.35mm +/-0.2mm
P	3.1mm NOM

Specifications	
Capacitance:	68 uF
Capacitance Tolerance:	20%
Voltage DC:	40 VDC, 46 VDC (Surge)
Temperature Range:	-55/+125°C
Rated Temperature:	125°C
Life:	2000 Hrs
Resistance:	38 mOhms (100kHz 20C)
Ripple Current:	1350 mAmps (100kHz 125C)
Leakage Current:	544 uA (2min 20°C)
High Temperature Solder:	No

Packaging Specifications	
Packaging:	T&R, 380mm
Packaging Quantity:	1000

Statements of suitability for certain applications are based on our knowledge of typical operating conditions for such applications, but are not intended to constitute - and we specifically disclaim - any warranty concerning suitability for a specific customer application or use. This Information is intended for use only by customers who have the requisite experience and capability to determine the correct products for their application. Any technical advice inferred from this Information or otherwise provided by us with reference to the use of our products is given gratis, and we assume no obligation or liability for the advice given or results obtained.