

**Description**

The 2316 designed by the trench processing techniques to achieve extremely low on-resistance. And fast switching speed and improved transfer effective . These features combine to make this design an extremely efficient and reliable device for variety of DC-DC applications.

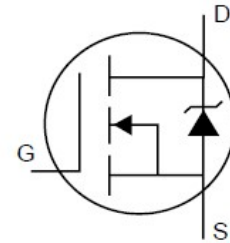

Schematic diagram

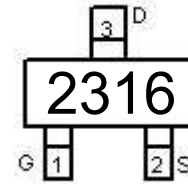

Marking and pin Assignment

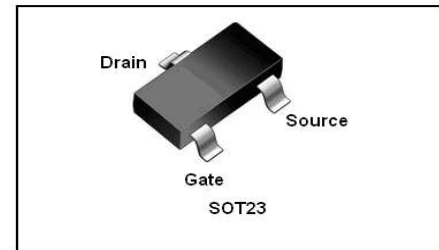

**Features**

- ◆ Ron(typ.)=50 mΩ @VGS=4.5V
- ◆ Ron(typ.)=44 mΩ @VGS=10V
- ◆ Low On-Resistance
- ◆ 150°C Operating Temperature
- ◆ Fast Switching
- ◆ Lead-Free, RoHS Compliant

**Application**

- Battery protection
- Load switch
- Power management

Symbol	Parameter		Rating	Unit
<b>Common Ratings (T<sub>c</sub>=25°C Unless Otherwise Noted)</b>				
V <sub>GS</sub>	Gate-Source Voltage		±12	V
V <sub>(BR)DSS</sub>	Drain-Source Breakdown Voltage		30	V
T <sub>J</sub>	Maximum Junction Temperature		150	°C
T <sub>STG</sub>	Storage Temperature Range		-50 to 155	°C
I <sub>S</sub>	Diode Continuous Forward Current	T <sub>c</sub> =25°C	4.0	A
<b>Mounted on Large Heat Sink</b>				
I <sub>DM</sub>	Pulse Drain Current Tested	T <sub>c</sub> =25°C	15	A
I <sub>D</sub>	Continuous Drain Current(VGS=10V)	T <sub>c</sub> =25°C	4.0	A
		T <sub>c</sub> =100°C	3.0	
P <sub>D</sub>	Maximum Power Dissipation	T <sub>c</sub> =25°C	1.25	W
R <sub>θJA</sub>	Thermal Resistance Junction-Ambient		135	°C/W

## N-Channel Power MOSFET

Symbol	Parameter	Condition	Min	Typ	Max	Unit
<b>Static Electrical Characteristics @ T<sub>J</sub> = 25°C (unless otherwise stated)</b>						
V <sub>(BR)DSS</sub>	Drain-Source Breakdown Voltage	V <sub>GS</sub> =0V, I <sub>D</sub> =250μA	30	--	--	V
I <sub>DSS</sub>	Zero Gate Voltage Drain Current (T <sub>c</sub> =25°C)	V <sub>DS</sub> =30V, V <sub>GS</sub> =0V	--	--	1	μA
	Zero Gate Voltage Drain Current (T <sub>c</sub> =125°C)	V <sub>DS</sub> =30V, V <sub>GS</sub> =0V	--	--	100	μA
I <sub>GSS</sub>	Gate-Body Leakage Current	V <sub>GS</sub> =±12V, V <sub>DS</sub> =0V	--	--	±100	nA
V <sub>GS(TH)</sub>	Gate Threshold Voltage	V <sub>DS</sub> =V <sub>GS</sub> , I <sub>D</sub> =250μA	0.5	0.9	1.5	V
R <sub>DS(ON)</sub>	Drain-Source On-State Resistance	V <sub>GS</sub> =4.5V, I <sub>D</sub> =3.0A	--	50	60	mΩ
R <sub>DS(ON)</sub>	Drain-Source On-State Resistance	V <sub>GS</sub> =10V, I <sub>D</sub> =4A	--	44	52	mΩ
<b>Dynamic Electrical Characteristics @ T<sub>J</sub> = 25°C (unless otherwise stated)</b>						
C <sub>iss</sub>	Input Capacitance	V <sub>DS</sub> =15V, V <sub>GS</sub> =0V, f=1MHz	--	245	--	pF
C <sub>oss</sub>	Output Capacitance		--	35	--	pF
C <sub>rss</sub>	Reverse Transfer Capacitance		--	18	--	pF
Q <sub>g</sub>	Total Gate Charge	V <sub>DS</sub> =15V, I <sub>D</sub> =2.8A, V <sub>GS</sub> =4.5V	--	4.8	--	nC
Q <sub>gs</sub>	Gate-Source Charge		--	1.1	--	nC
Q <sub>gd</sub>	Gate-Drain Charge		--	1.7	--	nC
<b>Switching Characteristics</b>						
t <sub>d(on)</sub>	Turn-on Delay Time	V <sub>DD</sub> =15V, I <sub>D</sub> =1A, R <sub>G</sub> =6Ω, V <sub>GS</sub> =4.5V, R <sub>L</sub> =5Ω,	--	3.5	--	nS
t <sub>r</sub>	Turn-on Rise Time		--	1.5	--	nS
t <sub>d(off)</sub>	Turn-Off Delay Time		--	18	--	nS
t <sub>f</sub>	Turn-Off Fall Time		--	2.5	--	nS
<b>Source- Drain Diode Characteristics</b>						
I <sub>SD</sub>	Source-drain current(Body Diode)	T <sub>c</sub> =25°C	--	--	4.0 <sup>①</sup>	A
I <sub>SDM</sub>	Pulsed Source-drain current (Body Diode)		--	--	15 <sup>①</sup>	A
V <sub>SD</sub>	Forward on voltage	T <sub>J</sub> =25°C, I <sub>SD</sub> =2.8A, V <sub>GS</sub> =0V	--	0.85	1.3	V

**Typical Electrical and Thermal Characteristics**

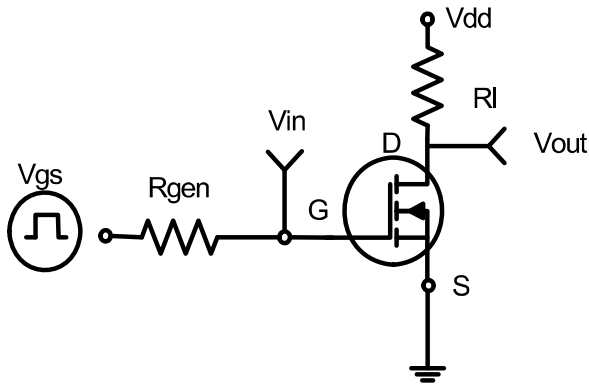

**Figure 1: Switching Test Circuit**

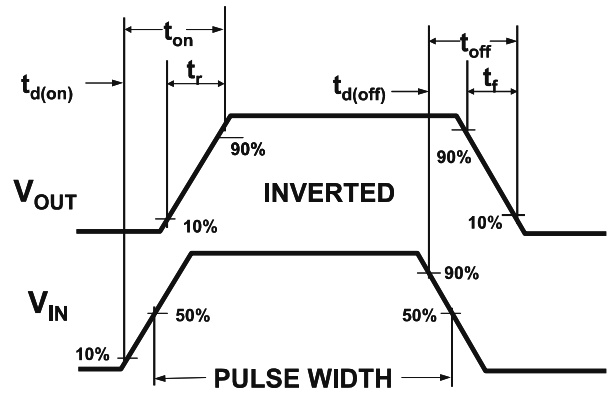

**Figure 2: Switching Waveforms**

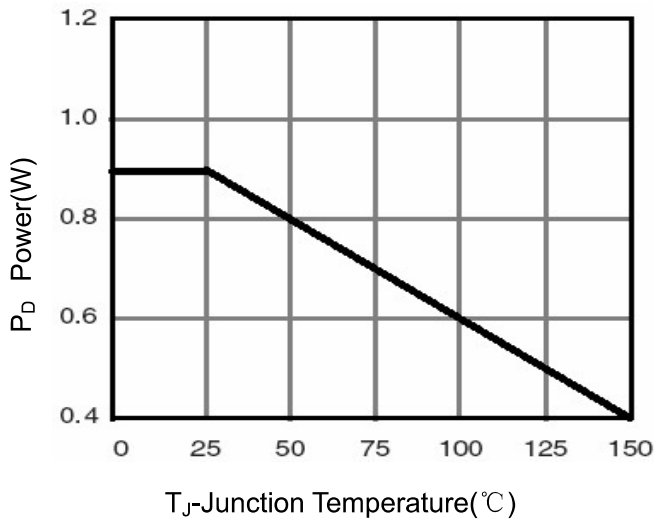

**Figure 3 Power Dissipation**

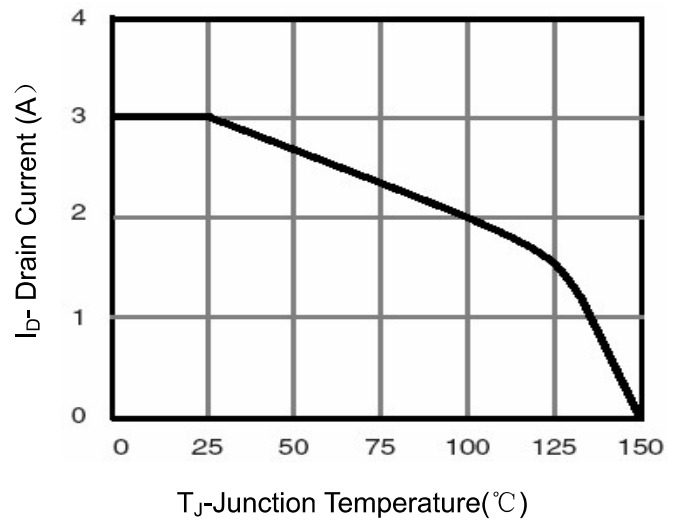

**Figure 4 Drain Current**

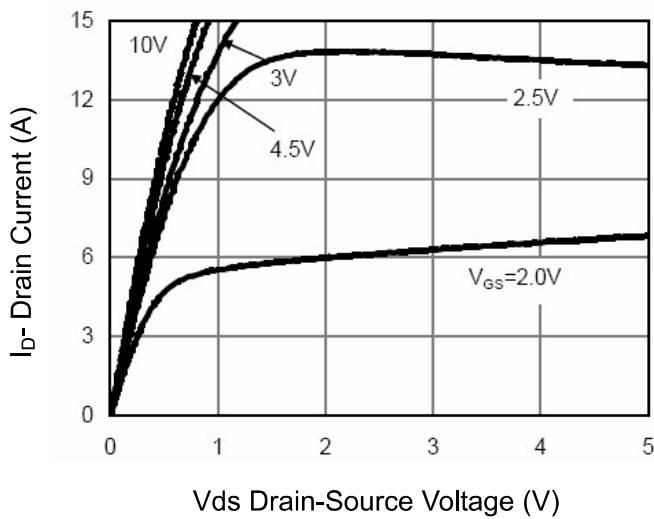

**Figure 5 Output Characteristics**

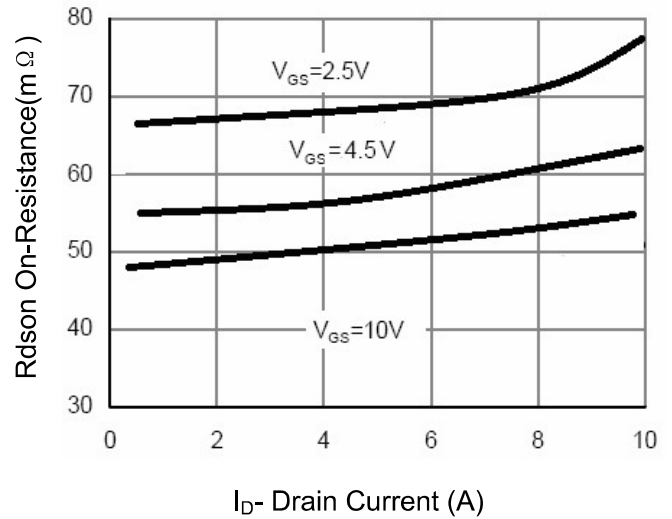

**Figure 6 Drain-Source On-Resistance**

**AP2316**

**N-Channel Power MOSFET**

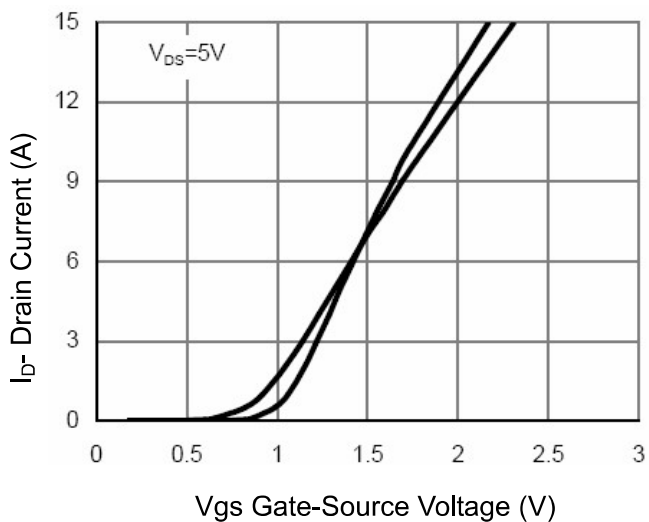

**Figure 7 Transfer Characteristics**

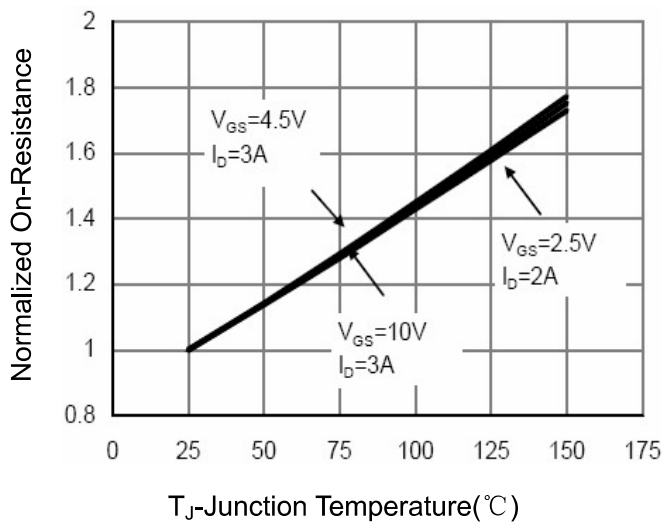

**Figure 8 Drain-Source On-Resistance**

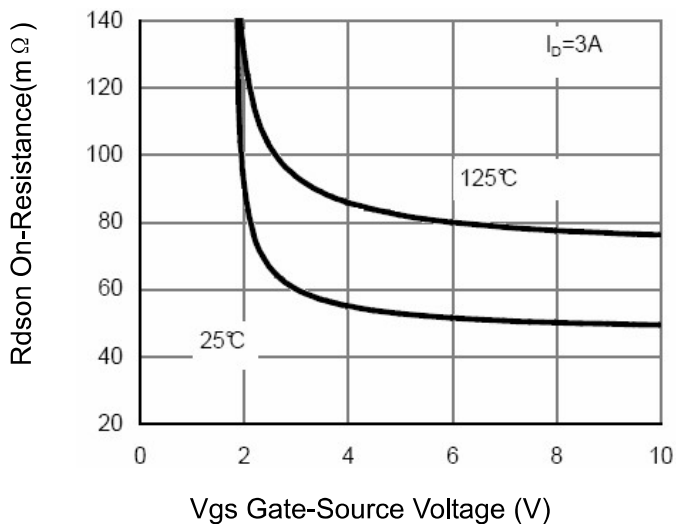

**Figure 9 Rdson vs Vgs**

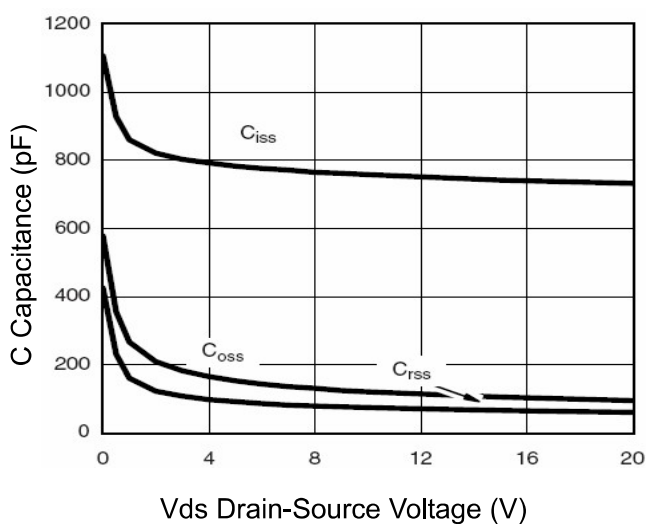

**Figure 10 Capacitance vs Vds**

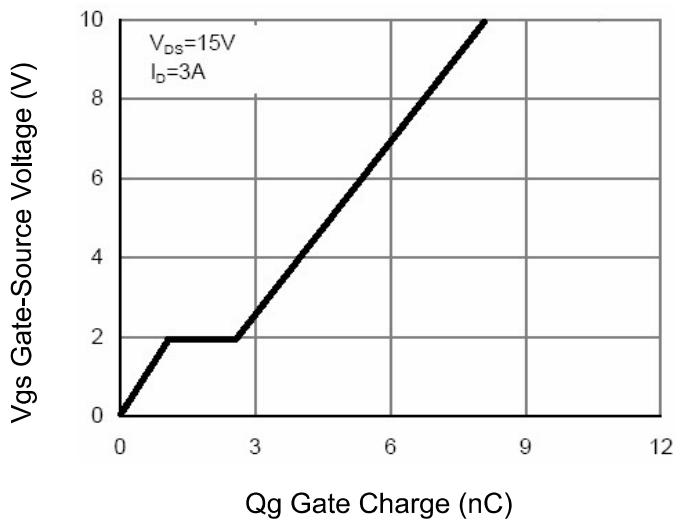

**Figure 11 Gate Charge**

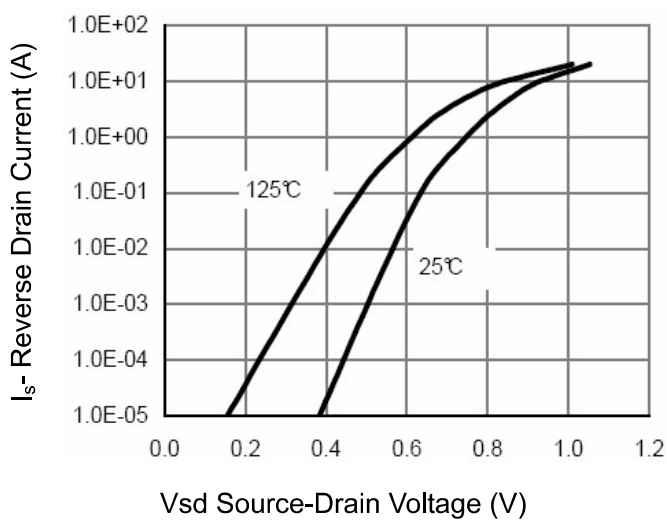

**Figure 12 Source- Drain Diode Forward**

**AP2316**  
**N-Channel Power MOSFET**

**SOT-23 Package Information**

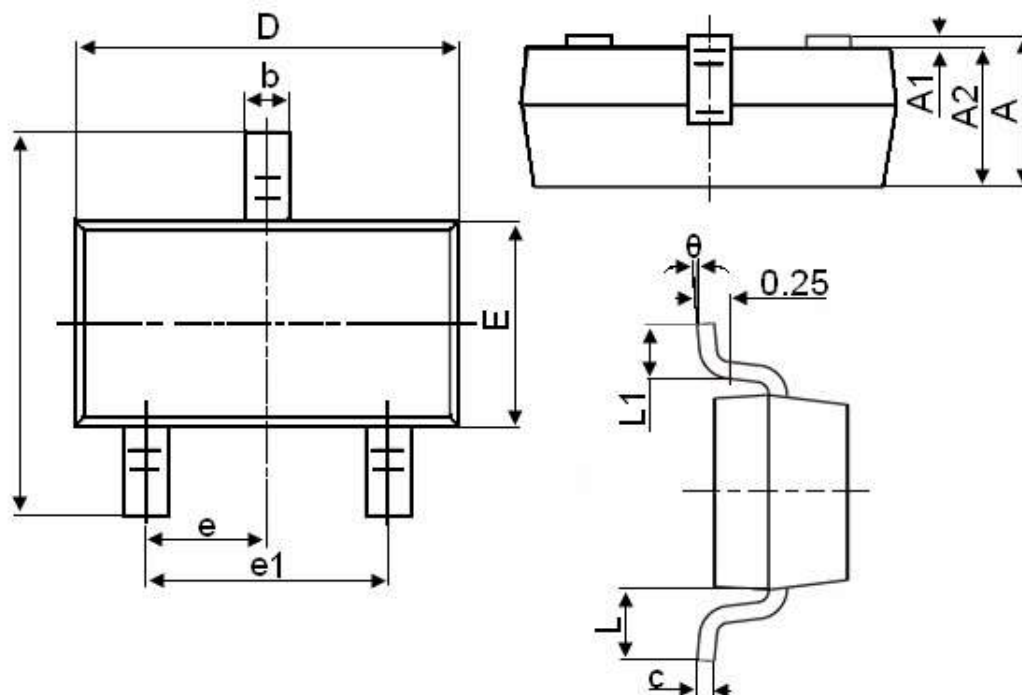

Symbol	Dimensions in Millimeters	
	MIN.	MAX.
A	0.900	1.150
A1	0.000	0.100
A2	0.900	1.050
b	0.300	0.500
c	0.080	0.150
D	2.800	3.000
E	1.200	1.400
E1	2.250	2.550
e	0.950TYP	
e1	1.800	2.000
L	0.550REF	
L1	0.300	0.500
$\theta$	0°	8°