

400 mA Low Noise and Low Supply Current LDO Regulator

NO.EA-403-200804

OVERVIEW

The RP122x is an LDO regulator that provides low output noise, high ripple rejection and fast response characteristics, achieved by low supply current. This device is suitable not only for noise-sensitive applications such as high-performance analog circuits, but also for various applications.

KEY BENEFITS

- Achieves Low Noise, High PSRR and Fast Response.
- Provides Saving Space by Adopting of 4-pin Small Package without Noise Bypass Capacitor.
- Provides Long-Duration of Operation for Battery-powered Equipment by Low Supply Current of 9.5 μ A (Typ.), despite the low-noise LDO.

KEY SPECIFICATIONS

- Input Voltage Range (Max.Rating): 1.9 V to 5.5 V (6.0 V)
- Output Voltage Range: 1.2 V to 4.8 V (0.1 V step)
- Output Voltage Accuracy: $\pm 0.8\%$ ($V_{SET} \geq 1.8$ V, $T_a = 25^\circ\text{C}$)
- Supply Current: Typ. 9.5 μ A
- Output Noise: Typ. 8 μ V_{rms} ($I_{OUT} = 250$ mA)
- Ripple Rejection: Typ. 90 dB ($f = 1$ kHz)
Typ. 85 dB ($f = 10$ kHz)
Typ. 65 dB ($f = 100$ kHz)
- Dropout Voltage: Typ. 0.145 V ($I_{OUT} = 400$ mA, $V_{SET} = 2.8$ V, RP122Z)
Typ. 0.170 V ($I_{OUT} = 400$ mA, $V_{SET} = 2.8$ V, RP122K)
- Protection Features: Thermal Shutdown Protection (Detection Temp. Typ. 165°C)
Inrush Current Limit at Typ. 250mA for appr. 700 μ s period after startup
- Ceramic Capacitor (C_{IN} , C_{OUT}): 1.0 μ F or more (No Need of Noise Bypass Capacitor)

TYPICAL APPLICATIONS

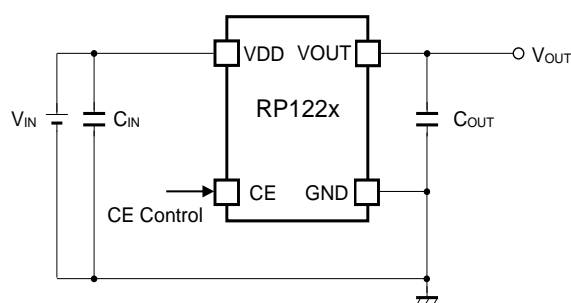

Without a bypass capacitor for noise

PACKAGE

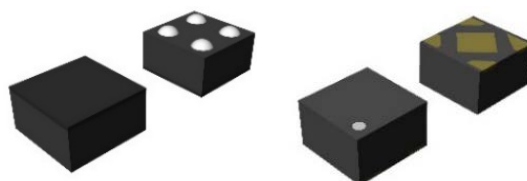

WLCSP-4-P8

0.64 mm x 0.64 mm,
t = 0.4 mm (Max.)

DFN(PLP)1010-4

1.00 mm x 1.00 mm,
t = 0.6 mm (Max.)

APPLICATIONS

- Mobile Phones and Tablets, Digital Cameras, Audio Devices, and Battery-powered Equipment
- RF Modules
- Clock Generator: VCO, PLL, etc.
- Noise-sensitive Devices: ADC, DAC

RP122x

NO.EA-403-200804

SELECTION GUIDE

The set output voltage and the auto-discharge function⁽¹⁾ are user-selectable.

Product Name	Package	Quantity per Reel	Pb Free	Halogen Free
RP122Zxx1*-TR-F	WLCSP-4-P8	5,000 pcs	Yes	Yes
RP122Kxx1*-TR	DFN(PLP)1010-4	10,000 pcs	Yes	Yes

xx: Specify the set output voltage (V_{SET}) within the range of 1.2 V to 4.8 V in 0.1 V steps.

The voltage in 0.05 V step is shown as follows.

Ex. 1.85 V: RP122x181*5

* : Specify whether with the auto-discharge or not.

B: without the auto-discharge function

D: with the auto-discharge function

BLOCK DIAGRAMS

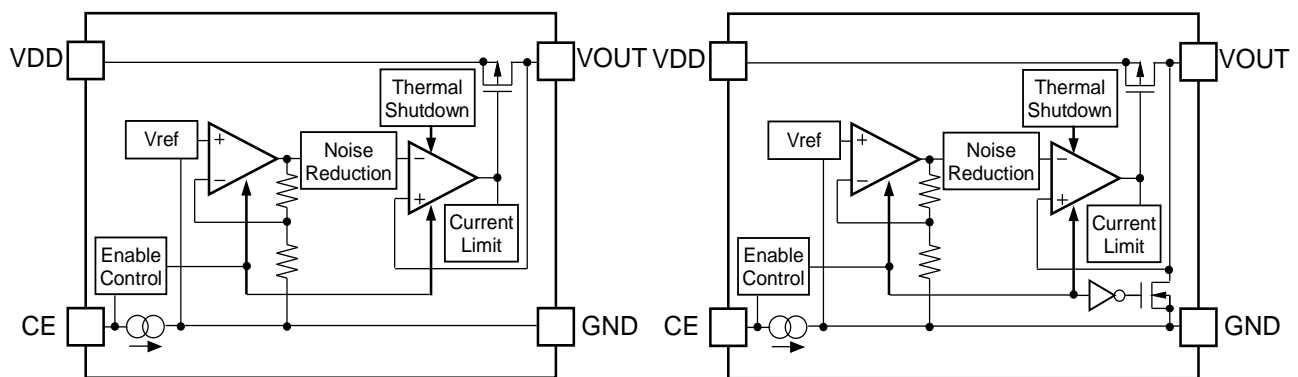

RP122xxx1B Block Diagram

RP122xxx1D Block Diagram

⁽¹⁾ Auto-discharge function quickly lowers the output voltage to 0 V, when the chip enable signal is switched from the active mode to the standby mode, by releasing the electrical charge accumulated in the external capacitor.

PIN DESCRIPTIONS

Top View

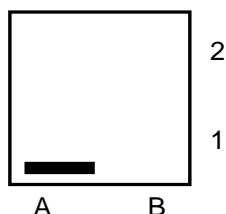

Bottom View

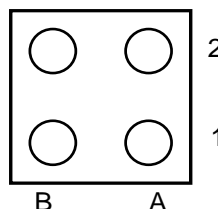

RP122Z (WLCSP-4-P8) Pin Configuration

Top View

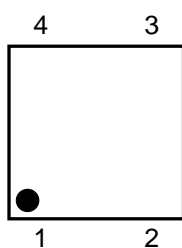

Bottom View

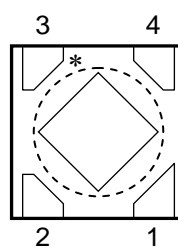

RP122K (DFN(PLP)1010-4) Pin Configuration

RP122Z Pin Description

Pin No.	Symbol	Description
A1	VDD	Input Pin
A2	VOUT	Output Pin
B1	CE	Chip Enable Pin, Active-high
B2	GND	Ground Pin

RP122K Pin Description

Pin. No.	Symbol	Description
1	VOUT	Output Pin
2	GND	Ground Pin
3	CE	Chip Enable Pin, Active-high
4	VDD	Input Pin

* The tab on the bottom of the package must be electrically connected to GND (substrate level) when mounted on the board.

RP122x

NO.EA-403-200804

ABSOLUTE MAXIMUM RATINGS

Symbol	Item	Rating	Unit	
V_{IN}	Input Voltage	-0.3 to 6.0	V	
V_{CE}	Input Voltage (CE pin)	-0.3 to 6.0	V	
V_{OUT}	Output Voltage	-0.3 to $V_{IN} + 0.3$	V	
I_{OUT}	Output Current	600	mA	
P_D	Power Dissipation ⁽¹⁾	WLCSP-4-P8, JEDEC STD.51-9	520	mW
		DFN(PLP) 1010-4, JEDEC STD.51-7	550	mW
T_j	Junction Temperature Range	-40 to 125	°C	
T_{stg}	Storage Temperature Range	-55 to 125	°C	

ABSOLUTE MAXIMUM RATINGS

Electronic and mechanical stress momentarily exceeded absolute maximum ratings may cause permanent damage and may degrade the life time and safety for both device and system using the device in the field. The functional operation at or over these absolute maximum ratings are not assured.

RECOMMENDED OPERATING CONDITIONS

Symbol	Item	Rating	Unit
V_{IN}	Input Voltage	1.9 to 5.5	V
T_a	Operating Temperature Range	-40 to 85	°C

RECOMMENDED OPERATING CONDITIONS

All of electronic equipment should be designed that the mounted semiconductor devices operate within the recommended operating conditions. The semiconductor devices cannot operate normally over the recommended operating conditions, even if they are used over such ratings by momentary electronic noise or surge. And the semiconductor devices may receive serious damage when they continue to operate over the recommended operating conditions.

⁽¹⁾ Refer to *POWER DISSIPATION* for detailed information.

ELECTRICAL CHARACTERISTICS

$V_{IN} = V_{SET} + 1\text{ V}$ ($V_{IN} = 5.5\text{ V}$ when $V_{SET} \geq 4.5\text{ V}$), $I_{OUT} = 1\text{ mA}$, $C_{IN} = C_{OUT} = 1\mu\text{F}$, unless otherwise specified.

The specifications surrounded by are guaranteed by design engineering at $-40^{\circ}\text{C} \leq T_a \leq 85^{\circ}\text{C}$.

RP122xxx1x Electrical Characteristics

($T_a = 25^{\circ}\text{C}$)

Symbol	Parameter		Conditions	Min.	Typ.	Max.	Unit	
V_{OUT}	Output Voltage		$T_a = 25^{\circ}\text{C}$	$V_{SET} \geq 1.8\text{V}$	x0.992	x1.008	V	
				$V_{SET} < 1.8\text{V}$	-14	+14	mV	
			$-40^{\circ}\text{C} \leq T_a \leq 85^{\circ}\text{C}$	$V_{SET} \geq 1.8\text{V}$	x0.987		x1.012	V
				$V_{SET} < 1.8\text{V}$	Refer to <i>PRODUCT-SPECIFIC ELECTRICAL CHARACTERISTICS</i>			
I_{OUT}	Output Current			400			mA	
$\Delta V_{OUT}/\Delta I_{OUT}$	Load Regulation	RP122Z	$1\text{ mA} \leq I_{OUT} \leq 400\text{ mA}$ $V_{IN} = V_{SET} + 0.5\text{ V}$, $V_{IN} \geq 1.9\text{ V}$		3	25	mV	
		RP122K	$1\text{ mA} \leq I_{OUT} \leq 400\text{ mA}$		13	40		
V_{DIF}	Dropout Voltage		$I_{OUT} = 400\text{ mA}$	Refer to <i>PRODUCT-SPECIFIC ELECTRICAL CHARACTERISTICS</i>				
I_{SS}	Supply Current		$I_{OUT} = 0\text{ mA}$		9.5	25	μA	
$I_{STANDBY}$	Standby Current		$V_{CE} = 0\text{ V}$		0.01	0.3	μA	
$\Delta V_{OUT}/\Delta V_{IN}$	Line Regulation		$1.2\text{V} \leq V_{SET} < 1.4\text{V}$	$1.9\text{V} \leq V_{IN} \leq 5.5\text{V}$	0.02	0.10	%V	
			$1.4\text{V} \leq V_{SET} < 4.3\text{V}$	$V_{SET} + 0.5\text{V} \leq V_{IN} \leq 5.5\text{V}$				
			$4.3\text{V} \leq V_{SET} \leq 4.8\text{V}$	$V_{SET} + 0.3\text{V} \leq V_{IN} \leq 5.5\text{V}$				
RR	Ripple Rejection		Ripple 0.2 Vp-p, $I_{OUT} = 20\text{ mA}$	$f = 1\text{ kHz}$	90		dB	
				$f = 10\text{ kHz}$	85			
				$f = 100\text{ kHz}$	65			
I_{SC}	Short Current Limit		$V_{OUT} = 0\text{ V}$		70		mA	
I_{PD}	CE Pull-down Current				0.25	0.50	μA	
V_{CEH}	CE Input Voltage, high			1.0			V	
V_{CEL}	CE Input Voltage, low					0.4	V	
en	Output Noise		BW=10Hz to 100kHz	$I_{OUT} = 1\text{ mA}$	12		μVrms	
				$I_{OUT} = 250\text{ mA}$	8			
T_{TSD}	Thermal Shutdown Temperature, detection		Junction Temperature		165		$^{\circ}\text{C}$	
T_{TSR}	Thermal Shutdown Temperature, released		Junction Temperature		110		$^{\circ}\text{C}$	
R_{LOW}	Auto-discharge NMOS On-resistance (RP122xxx1D only)		$V_{IN} = 5.0\text{ V}$, $CE = 0\text{ V}$,		50		Ω	

All test items listed under Electrical Characteristics are done under the pulse load condition ($T_j \approx T_a = 25^{\circ}\text{C}$) except Ripple Rejection and Output Noise.

RP122x

NO.EA-403-200804

The specifications surrounded by are guaranteed by design engineering at $-40^{\circ}\text{C} \leq T_a \leq 85^{\circ}\text{C}$

RP122Kxx1x Product-specific Electrical Characteristics

Product Name	V_{OUT} [V]						V_{DIF} [V]			
	$T_a = 25^{\circ}\text{C}$			$-40^{\circ}\text{C} \leq T_a \leq 85^{\circ}\text{C}$			RP122Z		RP122K	
	Min.	Typ.	Max.	Min.	Typ.	Max.	Typ.	Max.	Typ.	Max.
RP122x121x	1.186	1.200	1.214	1.180	1.200	1.218	(1)	(1)	(1)	(1)
RP122x121x5	1.236	1.250	1.264	1.230	1.250	1.268	(1)	(1)	(1)	(1)
RP122x131x	1.286	1.300	1.314	1.280	1.300	1.319	(1)	(1)	(1)	(1)
RP122x141x	1.386	1.400	1.414	1.379	1.400	1.419	(1)	0.450 ⁽²⁾	(1)	0.500 ⁽²⁾
RP122x151x	1.486	1.500	1.514	1.479	1.500	1.519	(1)	0.430	(1)	0.470
RP122x161x	1.586	1.600	1.614	1.578	1.600	1.620	0.240 ⁽²⁾	0.385	0.270 ⁽²⁾	0.425
RP122x171x	1.686	1.700	1.714	1.678	1.700	1.720	0.235	0.350	0.260	0.390
RP122x181x	1.786	1.800	1.814	1.777	1.800	1.821	0.215	0.325	0.240	0.365
RP122x181x5	1.836	1.850	1.864	1.826	1.850	1.872	0.215	0.325	0.240	0.365
RP122x191x	1.885	1.900	1.915	1.876	1.900	1.922	0.200	0.305	0.225	0.345
RP122x201x	1.984	2.000	2.016	1.974	2.000	2.024	0.190	0.290	0.215	0.330
RP122x211x	2.084	2.100	2.116	2.073	2.100	2.125	0.180	0.270	0.205	0.310
RP122x221x	2.183	2.200	2.217	2.172	2.200	2.226	0.170	0.260	0.195	0.300
RP122x231x	2.282	2.300	2.318	2.271	2.300	2.327	0.170	0.260	0.195	0.300
RP122x241x	2.381	2.400	2.419	2.369	2.400	2.428	0.170	0.260	0.195	0.300
RP122x251x	2.480	2.500	2.520	2.468	2.500	2.530	0.155	0.240	0.180	0.280
RP122x261x	2.580	2.600	2.620	2.567	2.600	2.631	0.155	0.240	0.180	0.280
RP122x271x	2.679	2.700	2.721	2.665	2.700	2.732	0.155	0.240	0.180	0.280
RP122x281x	2.778	2.800	2.822	2.764	2.800	2.833	0.145	0.225	0.170	0.265
RP122x281x5	2.828	2.850	2.872	2.813	2.850	2.884	0.145	0.225	0.170	0.265
RP122x291x	2.877	2.900	2.923	2.863	2.900	2.934	0.145	0.225	0.170	0.265
RP122x291x5	2.927	2.950	2.973	2.912	2.950	2.985	0.145	0.225	0.170	0.265
RP122x301x	2.976	3.000	3.024	2.961	3.000	3.036	0.145	0.225	0.170	0.265
RP122x301x5	3.026	3.050	3.074	3.011	3.050	3.086	0.145	0.225	0.170	0.265
RP122x311x	3.076	3.100	3.124	3.060	3.100	3.137	0.145	0.225	0.170	0.265
RP122x311x5	3.125	3.150	3.175	3.110	3.150	3.187	0.145	0.225	0.170	0.265
RP122x321x	3.175	3.200	3.225	3.159	3.200	3.238	0.145	0.225	0.170	0.265
RP122x331x	3.274	3.300	3.326	3.258	3.300	3.339	0.130	0.205	0.155	0.245
RP122x341x	3.373	3.400	3.427	3.356	3.400	3.440	0.130	0.205	0.155	0.245
RP122x351x	3.472	3.500	3.528	3.455	3.500	3.542	0.130	0.205	0.155	0.245

⁽¹⁾ Input voltage should be equal or more than the minimum operating voltage of 1.9 V.

⁽²⁾ When "Output voltage + Dropout Voltage" < 1.9 V, input voltage must be equal or more than the minimum operating voltage of 1.9 V.

The specifications surrounded by are guaranteed by design engineering at $-40^{\circ}\text{C} \leq T_a \leq 85^{\circ}\text{C}$

RP122Kxx1x Product-specific Electrical Characteristics

Product Name	V_{OUT} [V]						V_{DIF} [V]			
	$T_a = 25^{\circ}\text{C}$			$-40^{\circ}\text{C} \leq T_a \leq 85^{\circ}\text{C}$			RP122Z		RP122K	
	Min.	Typ.	Max.	Min.	Typ.	Max.	Typ.	Max.	Typ.	Max.
RP122x361x	3.572	3.600	3.628	3.554	3.600	3.643	0.120	0.195	0.145	0.235
RP122x371x	3.671	3.700	3.729	3.652	3.700	3.744	0.120	0.195	0.145	0.235
RP122x381x	3.770	3.800	3.830	3.751	3.800	3.845	0.120	0.195	0.145	0.235
RP122x391x	3.869	3.900	3.931	3.850	3.900	3.946	0.120	0.195	0.145	0.235
RP122x401x	3.968	4.000	4.032	3.948	4.000	4.048	0.115	0.185	0.140	0.225
RP122x411x	4.068	4.100	4.132	4.047	4.100	4.149	0.115	0.185	0.140	0.225
RP122x421x	4.167	4.200	4.233	4.146	4.200	4.250	0.115	0.185	0.140	0.225
RP122x421x5	4.216	4.250	4.284	4.195	4.250	4.301	0.115	0.185	0.140	0.225
RP122x431x	4.266	4.300	4.334	4.245	4.300	4.351	0.115	0.185	0.140	0.225
RP122x441x	4.365	4.400	4.435	4.343	4.400	4.452	0.115	0.185	0.140	0.225
RP122x451x	4.464	4.500	4.536	4.442	4.500	4.554	0.115	0.185	0.140	0.225
RP122x451x5	4.514	4.550	4.586	4.491	4.550	4.604	0.115	0.185	0.140	0.225
RP122x461x	4.564	4.600	4.636	4.541	4.600	4.655	0.115	0.185	0.140	0.225
RP122x471x	4.663	4.700	4.737	4.639	4.700	4.756	0.115	0.185	0.140	0.225
RP122x481x	4.762	4.800	4.838	4.738	4.800	4.857	0.115	0.185	0.140	0.225

THEORY OF OPERATION

Inrush Current Limit

The inrush current limit value at start-up increases in proportion to the capacitance of C_{OUT} . If not flow the load current (I_{LOAD}) except the charge current to C_{OUT} , the inrush current reaches 250mA when the effective capacitance of C_{OUT} becomes appr.6.0 μ F or more, and the inrush current limit protection runs. During appr.700 μ s after the CE pin becomes "H", the inrush current, which occurs at charging the capacitor of C_{OUT} , is limited at appr.250 mA. The power-on time (t_{ON}) can be calculated from the following equation. If the capacitance value of C_{OUT} is too much, the time-out occurs and the inrush current increases.

$$t_{ON} = t_D + C_{OUT} \cdot V_{SET} / I_{LIM_START}$$

t_D : Delay Time at Start-up Typ.50 μ s

V_{SET} : Set Output Voltage

I_{LIM_START} : Limit Current at Start-up Typ.250 mA

If flow the load current (I_{LOAD}) except the charge current to C_{OUT} during start-up, the start-up time becomes longer. The load current over I_{LIM_START} cannot be applied.

Minimum Operating Voltage

The RP122x does not include an UVLO circuit. To make the internal circuit operate normally and to ensure good output regulation, V_{IN} has to be: $V_{IN} \geq V_{SET} + V_{DIF}$ (Min.1.9 V). To bring out the best characteristics of the output noise voltage, the ripple rejection and the load transient response, V_{IN} has to be $V_{IN} = V_{SET} + 1.0$ V.

Thermal Shutdown Protection

Thermal shutdown deactivates a circuit when the junction temperature exceeds the thermal shutdown threshold (T_{TSD}) of Typ. 165°C, and reactivates it when the junction temperature falls below the thermal shutdown release threshold (T_{TSR}) of Typ. 110°C. During the reactivation, the inrush current limit is in operation. Note that deactivation and activation cycle can be repeated due to load, heat dissipation and ambient temperature conditions. Thermal shutdown cannot be used for the purpose of heat sink, so the repetitive cycles of deactivation and activation may affect the reliability of the device.

APPLICATION INFORMATION

Typical Application Circuit

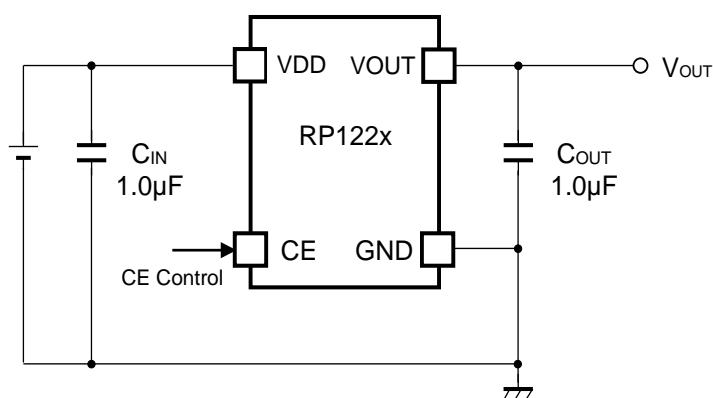

RP122x Typical Application Circuit

Technical Notes Related to External Components

- Ensure the VDD and GND lines are sufficiently robust. If their impedances are too high, noise pickup or unstable operation may result. Connect a 1.0 µF or more input capacitor (C_{IN}) between the VDD and GND pins with shortest-distance wiring. It is recommended to use a ceramic capacitor of 6.3 V and more such as the X7R and the X5R having small temperature dependence to ESR, ESL, and capacitance.
- Phase compensation is provided to secure stable operation even when the load current is varied. For this purpose, use a ceramic capacitor of 1.0 µF or more with ESR (Equivalent Series Resistance) of up to 300 mΩ to connect an output capacitor (C_{OUT}) between the VOUT and GND pins with shortest-distance wiring. Besides, set for the output capacitor to ensure the following effective capacitance in consideration of the dependence of temperature, DC bias, and package size.

Set Output Voltage (V_{SET})	Effective Capacitance
$1.2\text{ V} \leq V_{SET} < 2.0\text{ V}$	0.75 µF and more
$2.0\text{ V} \leq V_{SET} < 3.4\text{ V}$	0.70 µF and more
$3.4\text{ V} \leq V_{SET} \leq 4.8\text{ V}$	0.60 µF and more

In case of using a tantalum type capacitor with a large ESR, the output might become unstable. Evaluate your circuit including consideration of frequency characteristics with a parallel connection the above ceramic and the tantalum type capacitors.

TYPICAL CHARACTERISTICS

Typical Characteristics are intended to be used as reference data, they are not guaranteed.

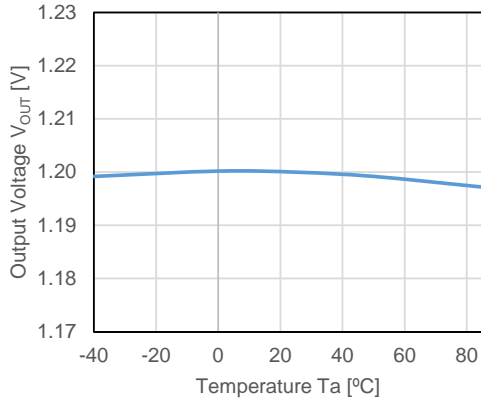
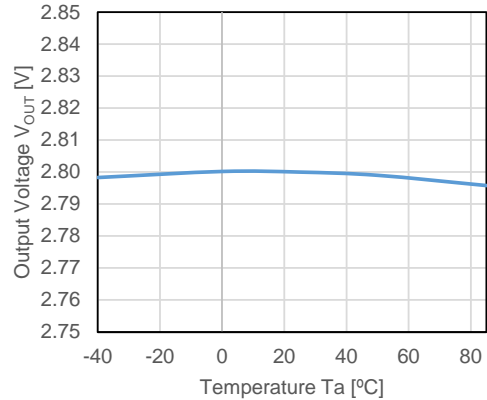
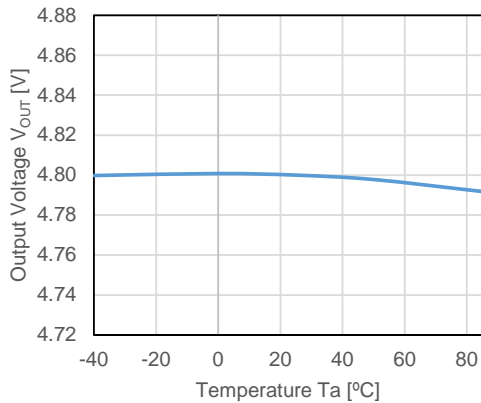
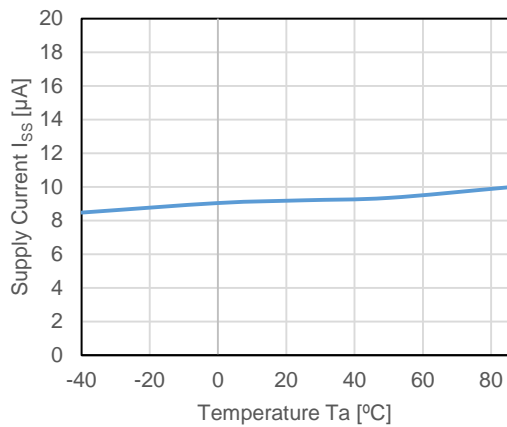
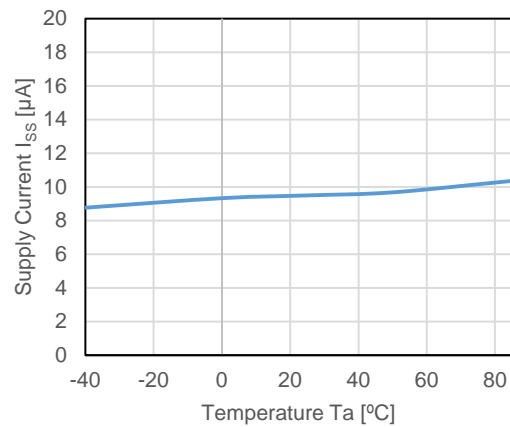
1) Output Voltage vs. Temperature ($C_{IN} = \text{Ceramic } 1.0 \mu\text{F}$, $C_{OUT} = \text{Ceramic } 1.0 \mu\text{F}$)RP122x121x, $V_{IN} = 2.2 \text{ V}$, $I_{OUT} = 1 \text{ mA}$ RP122x281x, $V_{IN} = 3.8 \text{ V}$, $I_{OUT} = 1 \text{ mA}$ RP122x481x, $V_{IN} = 5.5 \text{ V}$, $I_{OUT} = 1 \text{ mA}$ **2) Supply Current vs. Temperature ($C_{IN} = \text{Ceramic } 1.0 \mu\text{F}$, $C_{OUT} = \text{Ceramic } 1.0 \mu\text{F}$)**RP122x121x, $V_{IN} = 2.2 \text{ V}$ RP122x281x, $V_{IN} = 3.8 \text{ V}$ 

RP122x481x, $V_{IN} = 5.5\text{ V}$

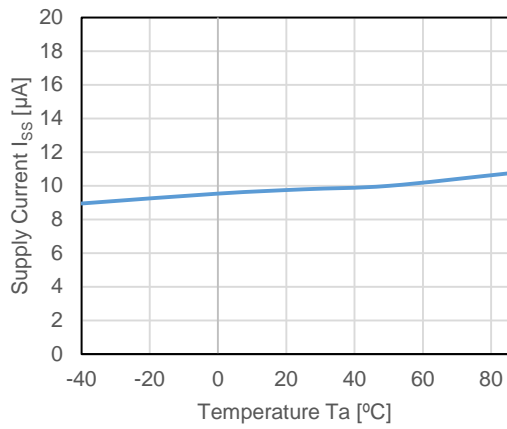

3) Dropout Voltage vs. Output Current ($C_{IN} = \text{Ceramic } 1.0\ \mu\text{F}$, $C_{OUT} = \text{Ceramic } 1.0\ \mu\text{F}$)

RP122Z181x

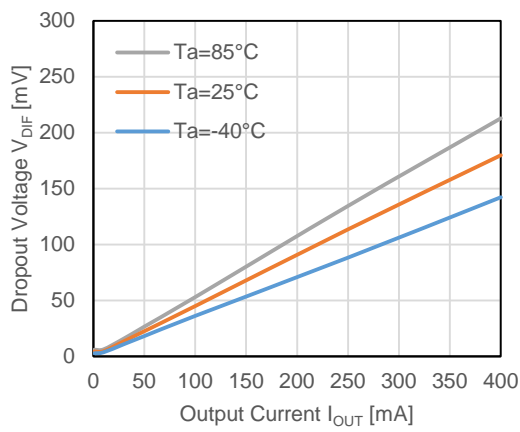

RP122K181x

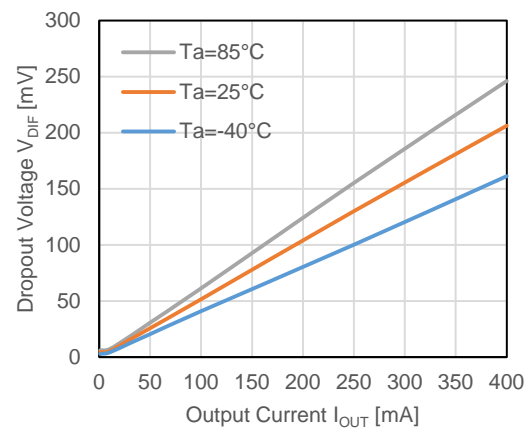

RP122Z281x

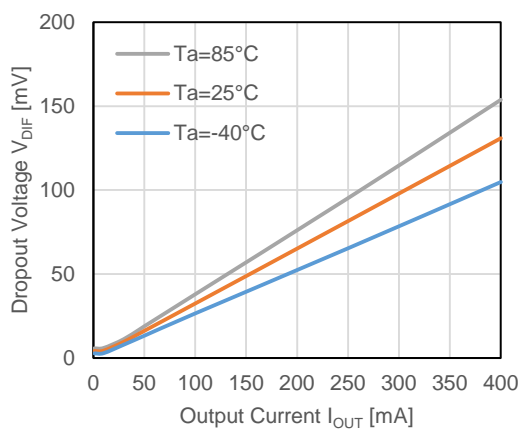

RP122K281x

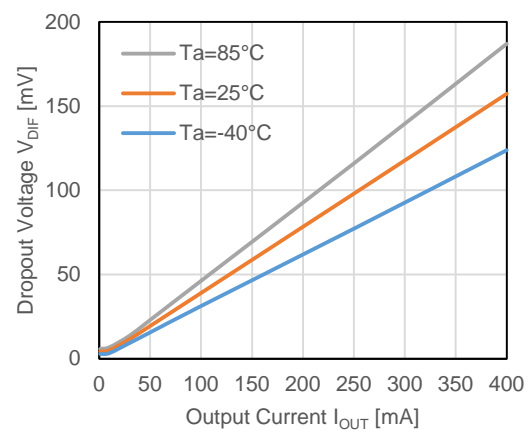

RP122x

NO.EA-403-200804

RP122Z481x

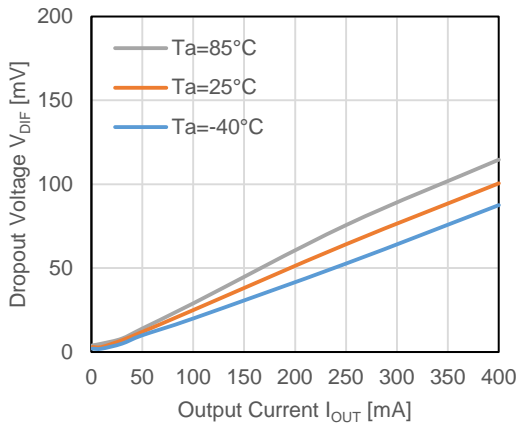

RP122K481x

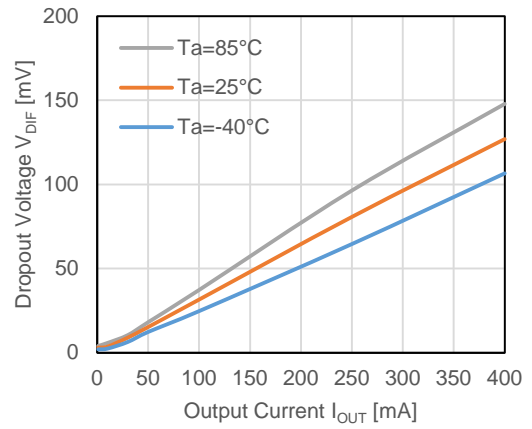

4) Dropout Voltage vs. Temperature (C_{IN} = Ceramic 1.0 μF , C_{OUT} = Ceramic 1.0 μF)

RP122Z181x

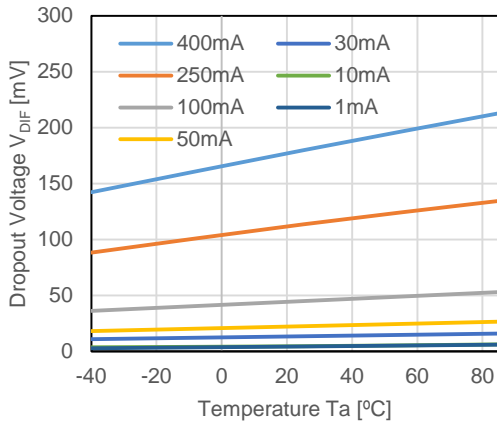

RP122K181x

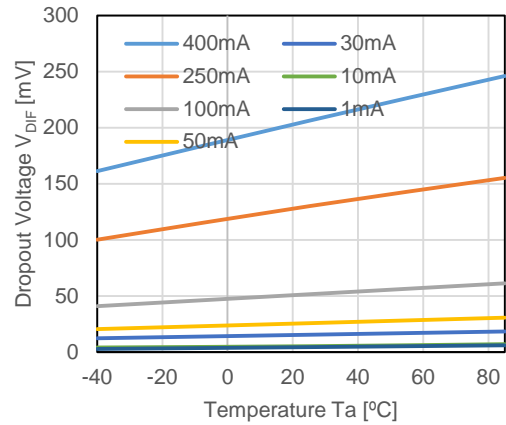

RP122Z281x

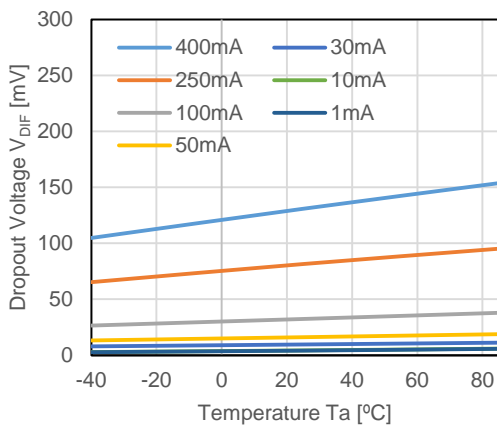

RP122K281x

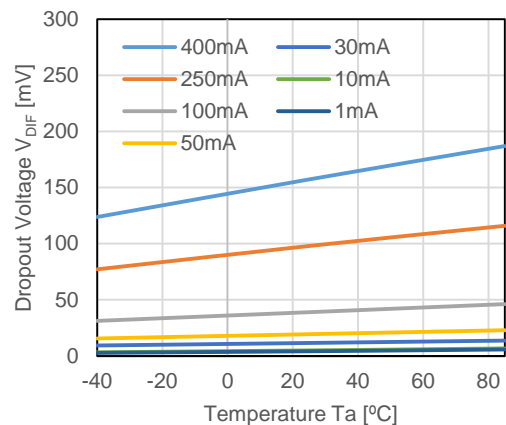

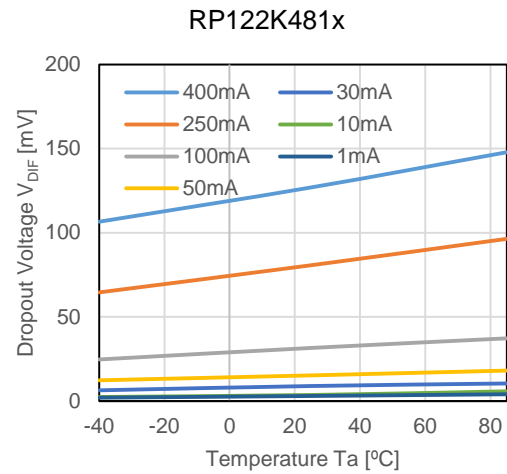
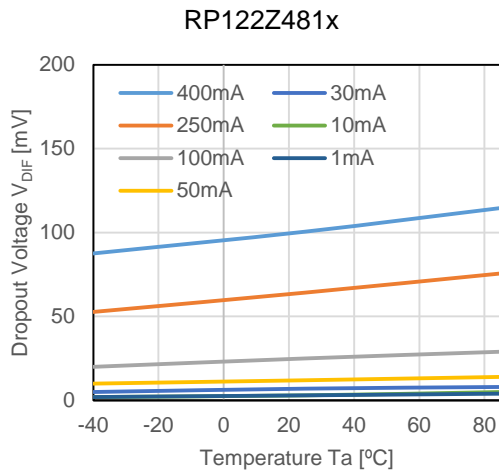

5) Dropout Voltage vs. Set Output Voltage (C_{IN} = Ceramic 1.0 μ F, C_{OUT} = Ceramic 1.0 μ F, T_a = 25°C)

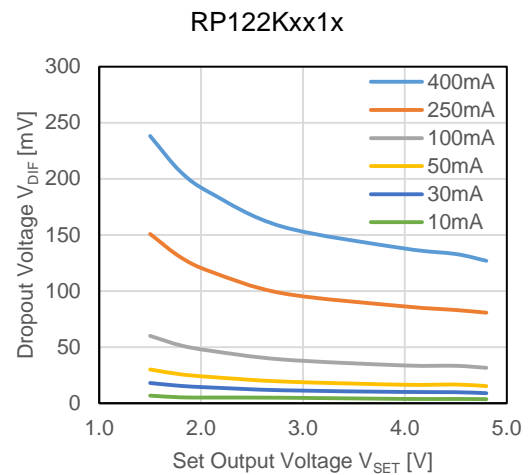
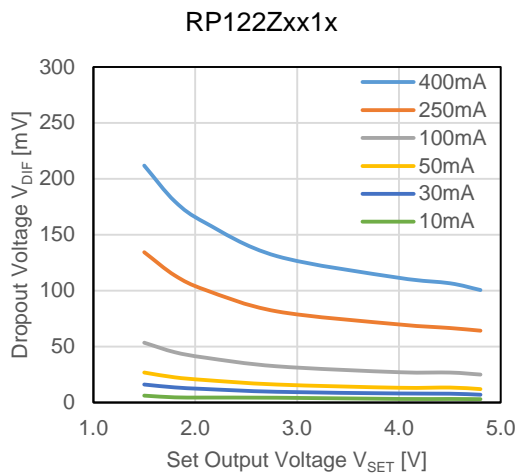

6) Output Voltage vs. Output Current (C_{IN} = Ceramic 1.0 μ F, C_{OUT} = Ceramic 1.0 μ F, T_a = 25°C)

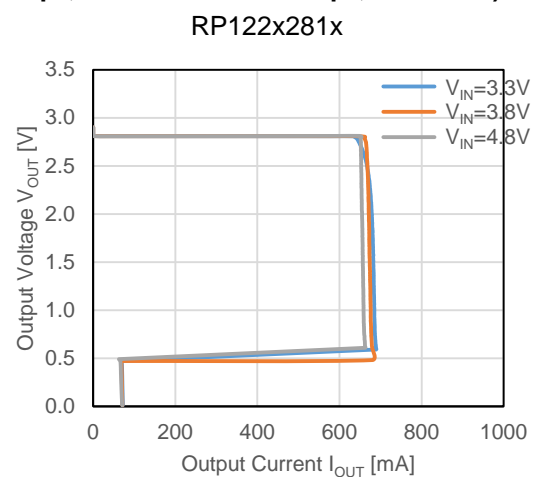
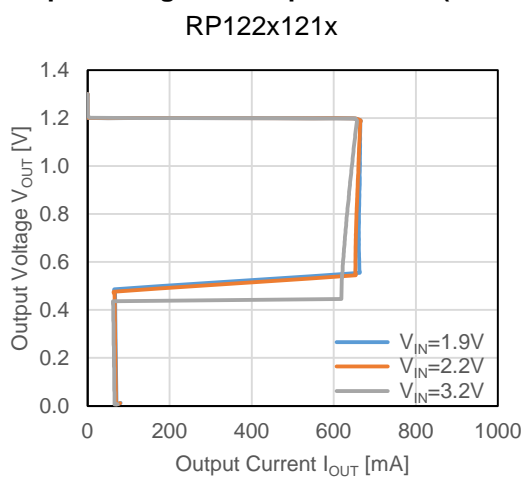

RP122x

NO.EA-403-200804

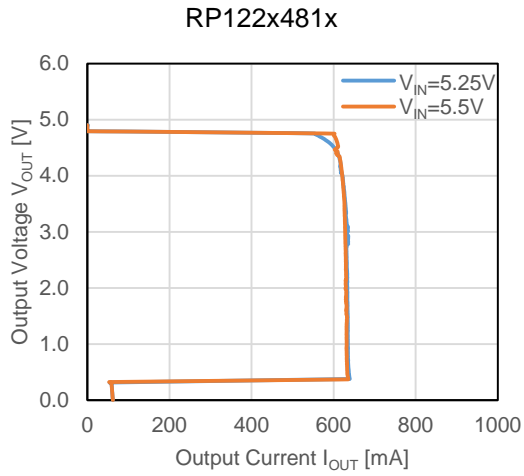

7) Output Voltage vs. Input Voltage (C_{IN} = Ceramic 1.0 μF , C_{OUT} = Ceramic 1.0 μF , T_a = 25°C)

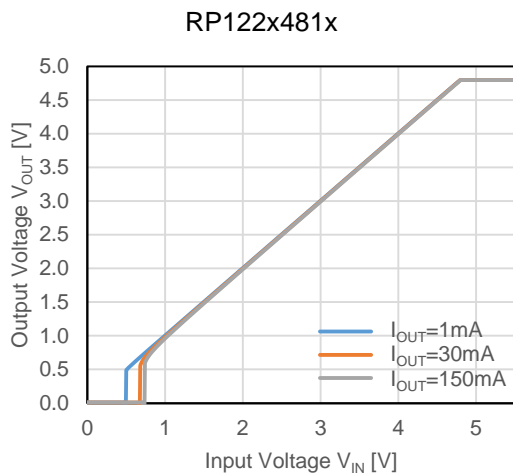
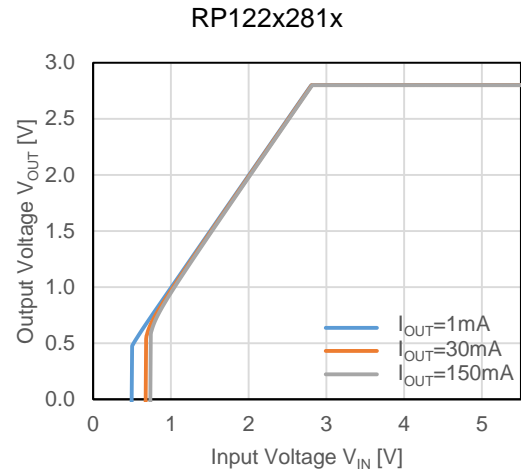
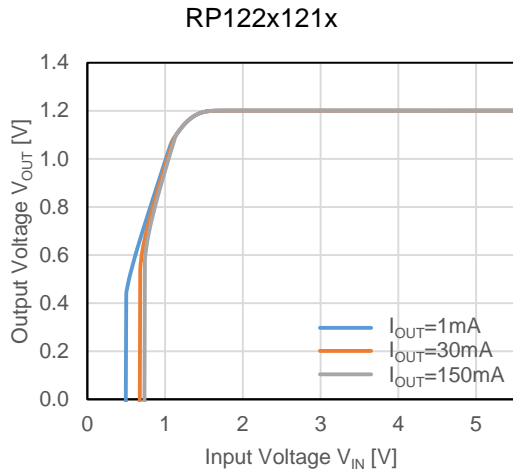

8) Supply Current vs. Input Voltage ($C_{IN} = \text{Ceramic } 1.0 \mu\text{F}$, $C_{OUT} = \text{Ceramic } 1.0 \mu\text{F}$, $T_a = 25^\circ\text{C}$)

RP122x121x

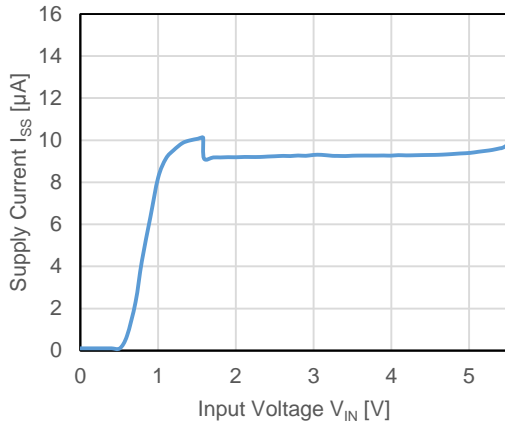

RP122x281x

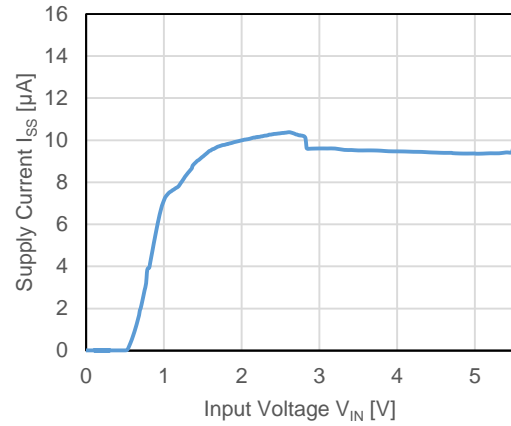

RP122x481x

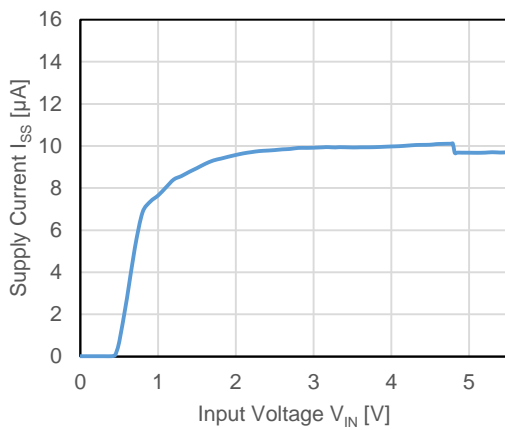

9) Supply Current vs. Output Current ($C_{IN} = \text{Ceramic } 1.0 \mu\text{F}$, $C_{OUT} = \text{Ceramic } 1.0 \mu\text{F}$, $T_a = 25^\circ\text{C}$)

RP122x121x, $V_{IN} = 2.2 \text{ V}$

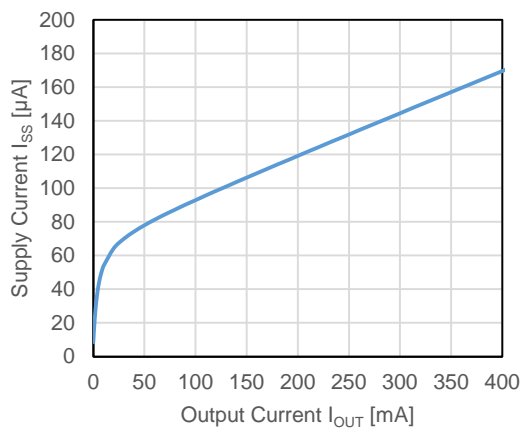

RP122x281x, $V_{IN} = 3.8 \text{ V}$

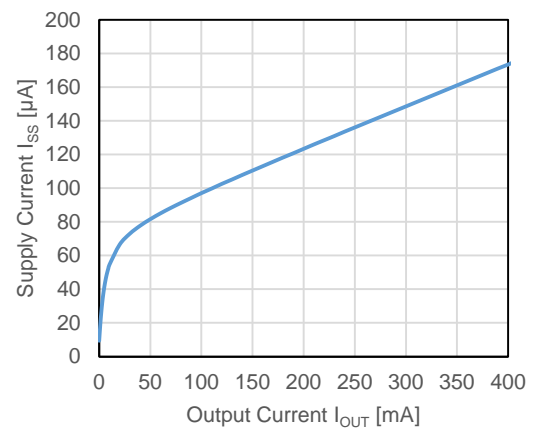

RP122x

NO.EA-403-200804

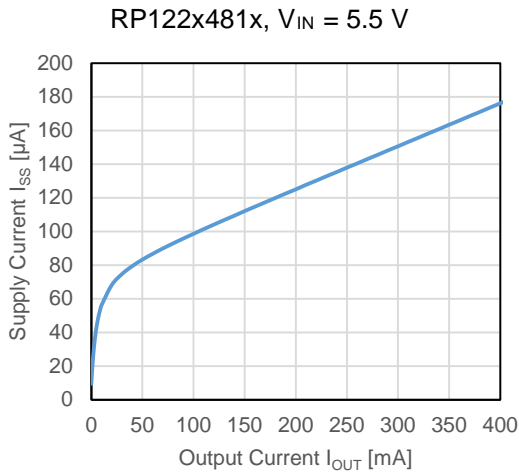

10) Ripple Rejection vs. Frequency ($C_{OUT} = \text{Ceramic } 1.0\ \mu\text{F}$, Ripple = 0.2 Vp-p, $T_a = 25^\circ\text{C}$)

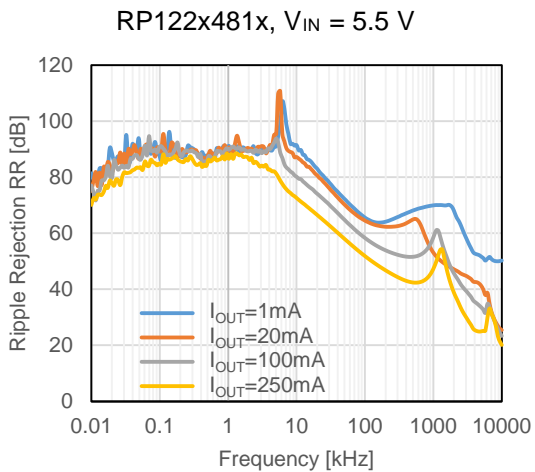
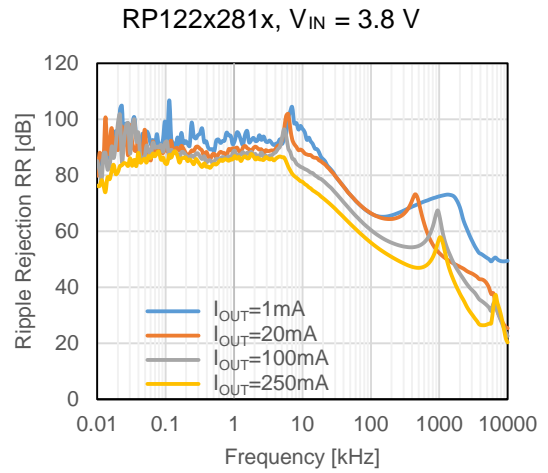
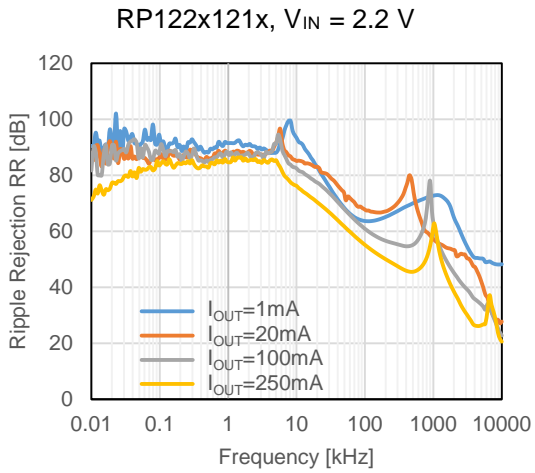

11) Ripple Rejection vs. Input Voltage (C_{OUT} = Ceramic 1.0 μ F, Ripple = 0.2 Vp-p, T_a = 25°C)

RP122x121x, I_{OUT} = 1 mA

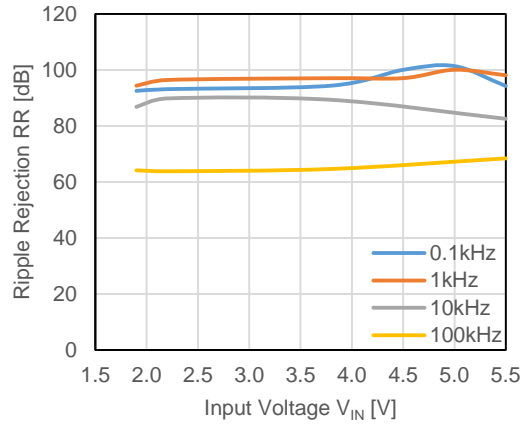

RP122x121x, I_{OUT} = 20 mA

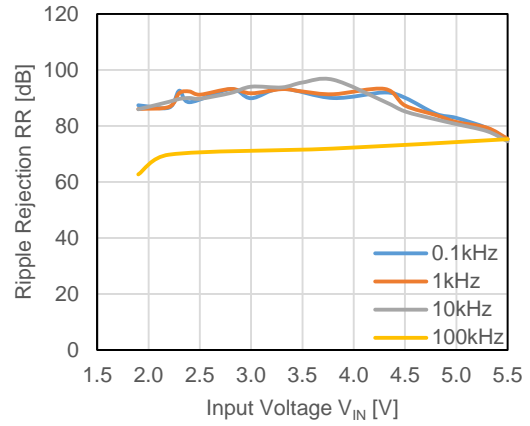

RP122x281x, I_{OUT} = 1 mA

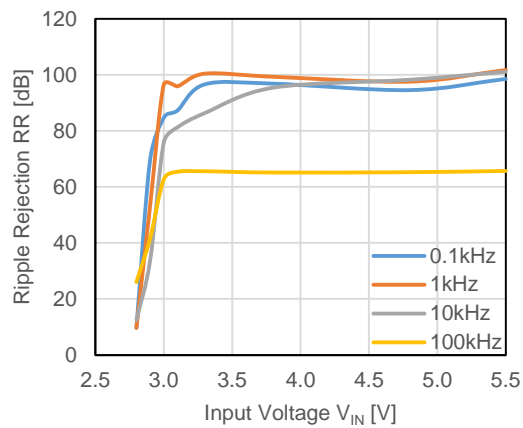

RP122x281x, I_{OUT} = 20 mA

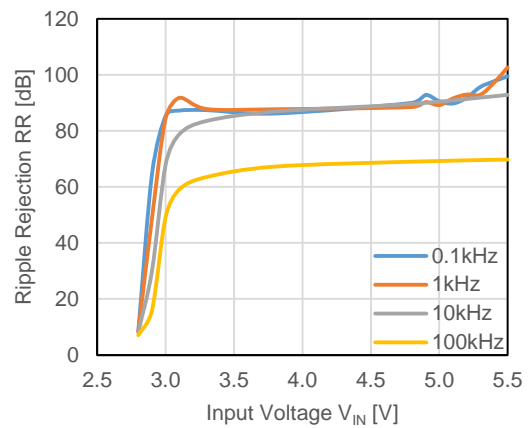

RP122x481x, I_{OUT} = 1 mA

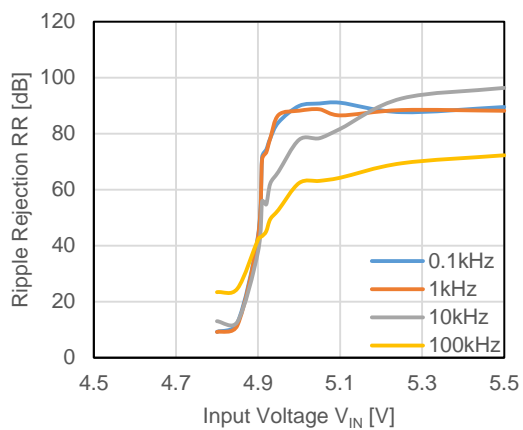

RP122x481x, I_{OUT} = 20 mA

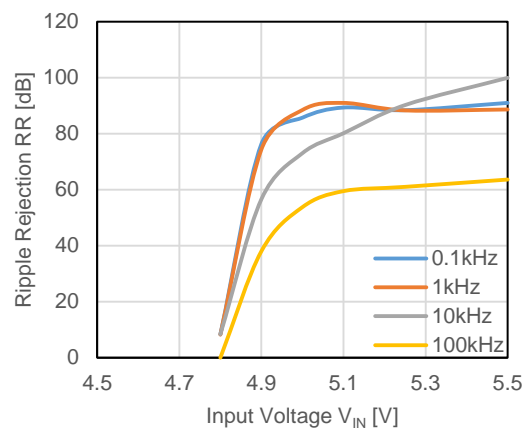

RP122x121x, I_{OUT} = 100 mA

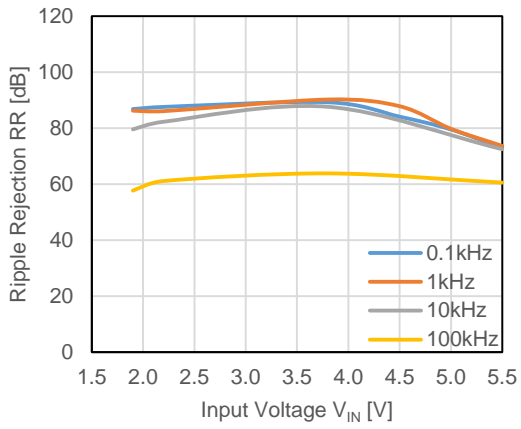

RP122x121x, I_{OUT} = 250 mA

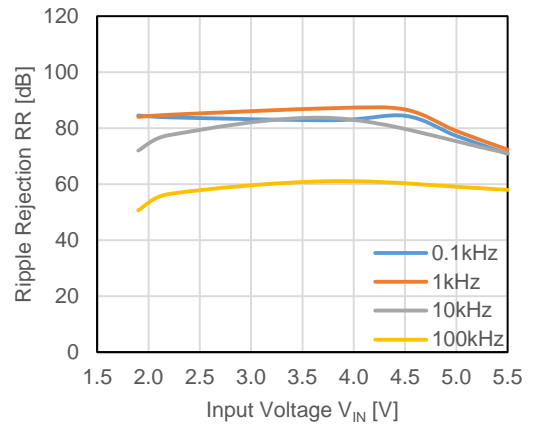

RP122x281x, I_{OUT} = 100 mA

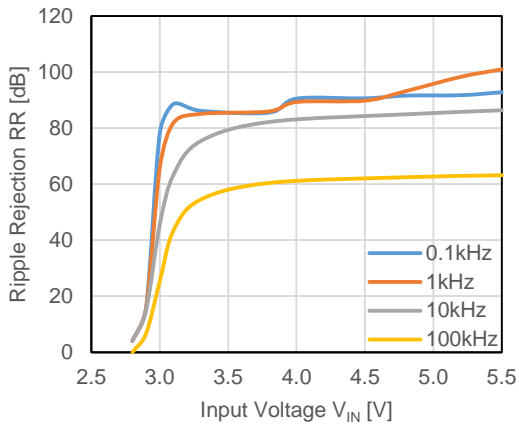

RP122x281x, I_{OUT} = 250 mA

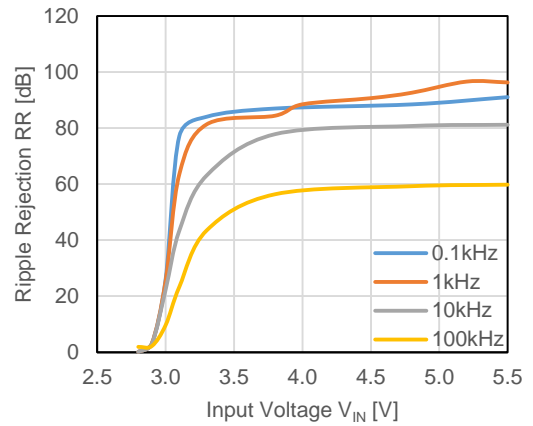

RP122x481x, I_{OUT} = 100 mA

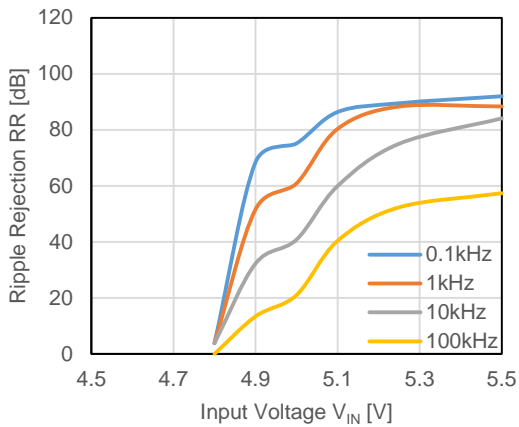

RP122x481x, I_{OUT} = 250 mA

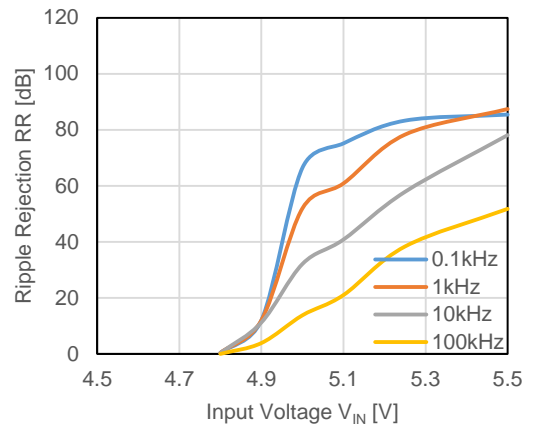

12) Output Noise Spectral Density vs. Frequency (C_{IN} =Ceramic 1.0 μ F, C_{OUT} =Ceramic 1.0 μ F, T_a =25°C)

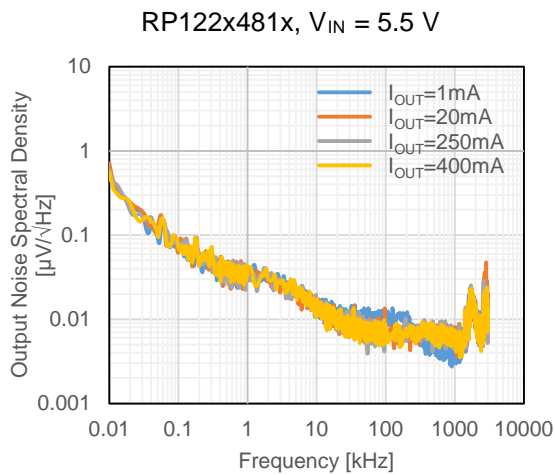
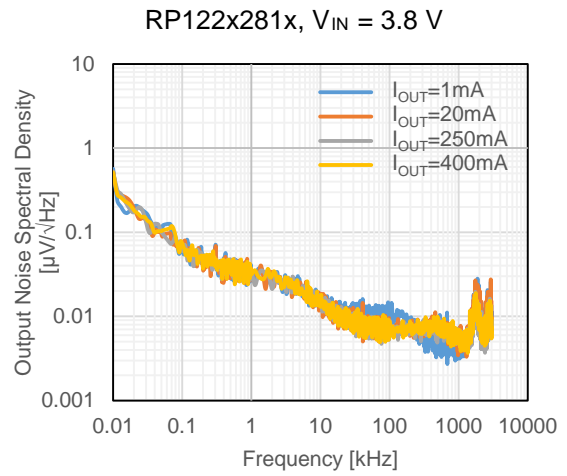
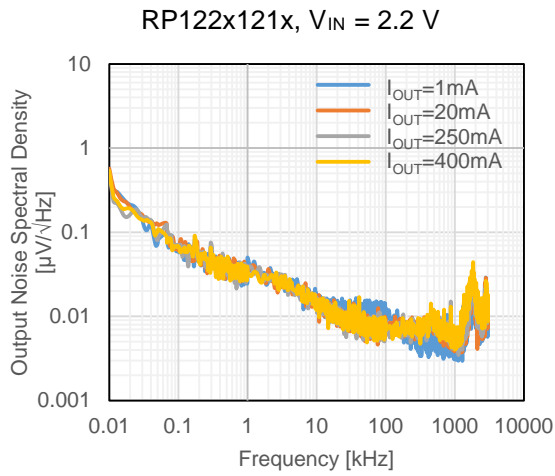

13) Input Transient Response ($C_{IN} =$ Ceramic 1.0 μ F, $C_{OUT} =$ Ceramic 1.0 μ F, $t_R = t_F = 5$ μ s, $T_a = 25^\circ$ C)

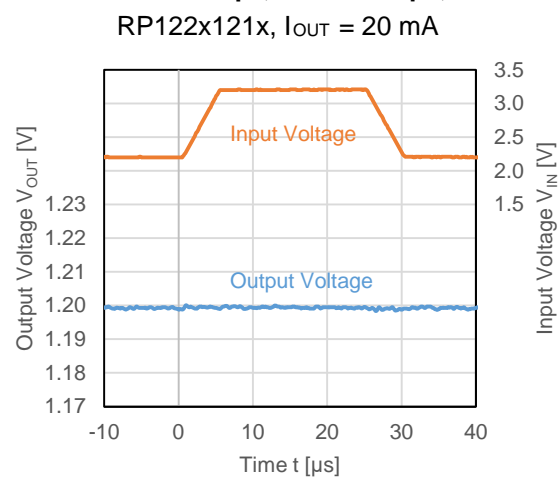
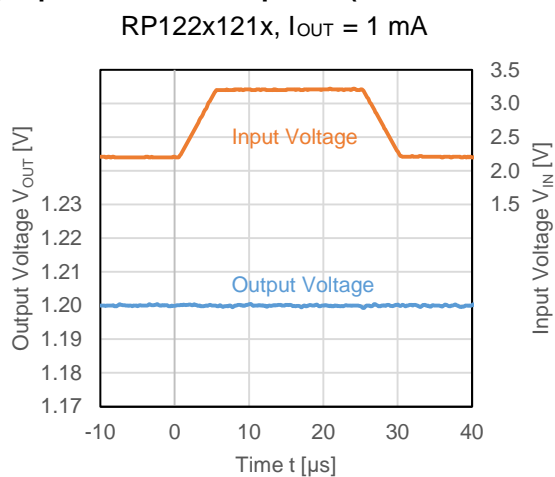

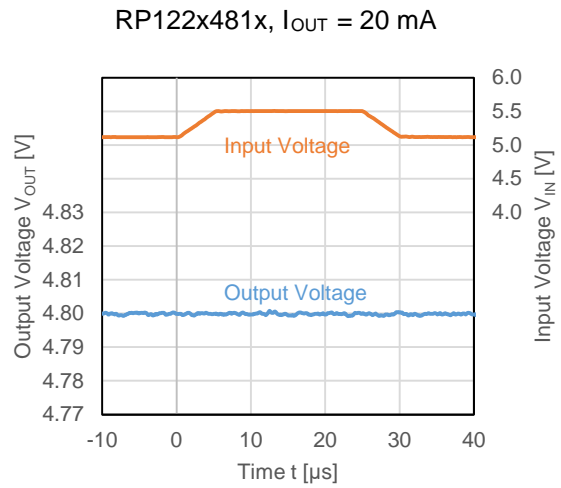
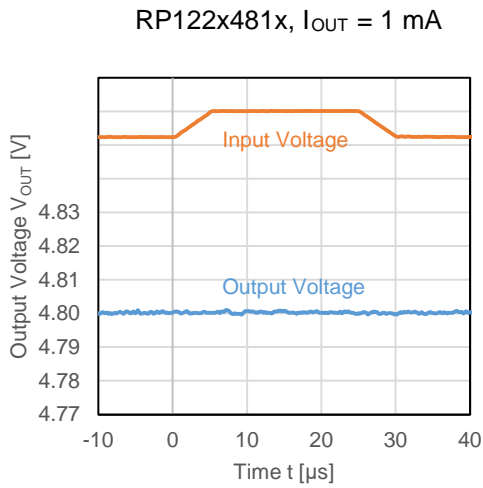
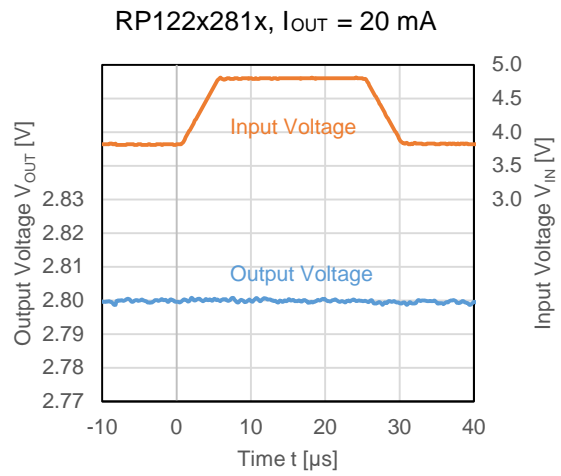
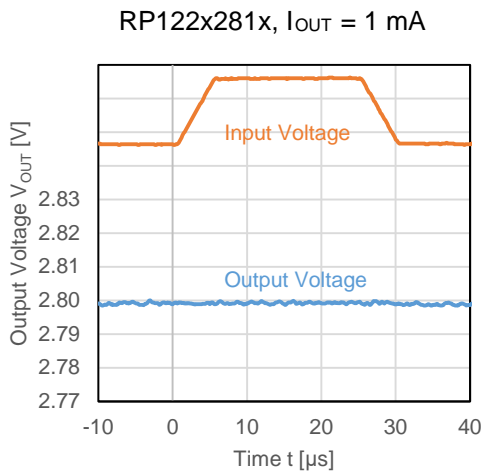

14) Load transient Response ($C_{IN} = \text{Ceramic } 1.0\ \mu\text{F}$, $C_{OUT} = \text{Ceramic } 1.0\ \mu\text{F}$, $T_a = 25^\circ\text{C}$)

RP122x121x, $V_{IN} = 2.2\text{ V}$,
 $I_{OUT} = 1\text{ mA} \Leftrightarrow 250\text{ mA}$, $t_R = t_F = 10\ \mu\text{s}$

RP122x121x, $V_{IN} = 2.2\text{ V}$,
 $I_{OUT} = 0 \Rightarrow 400\text{ mA}$, $t_R = 0.5\ \mu\text{s}$

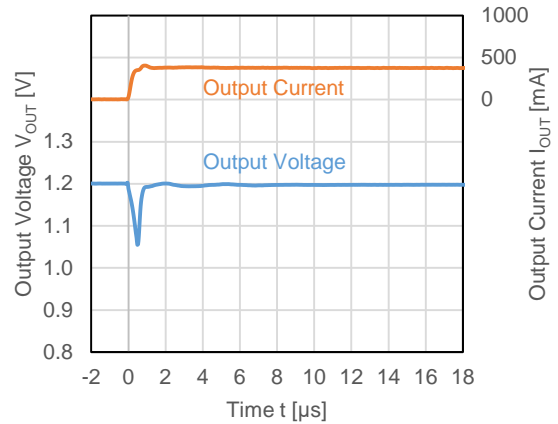
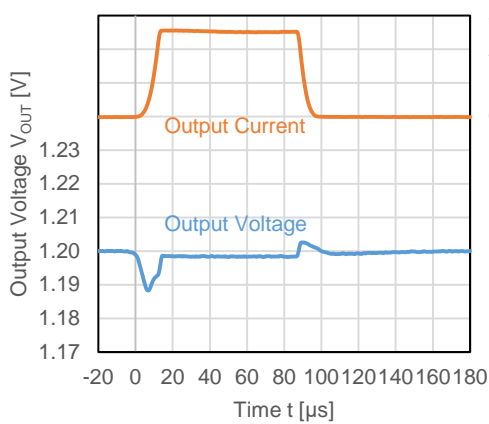

RP122x281x, $V_{IN} = 3.8\text{ V}$,
 $I_{OUT} = 1\text{ mA} \Leftrightarrow 250\text{ mA}$, $t_R = t_F = 10\ \mu\text{s}$

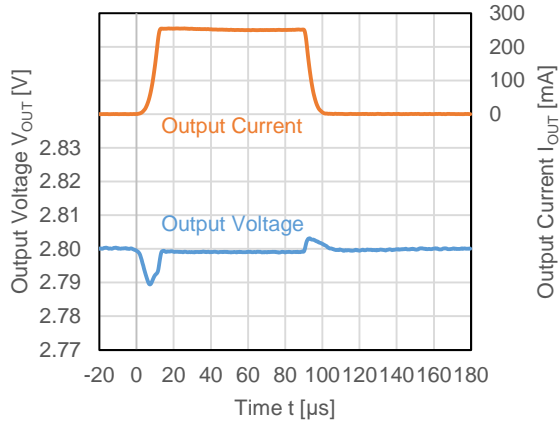

RP122x281x, $V_{IN} = 3.8\text{ V}$,
 $I_{OUT} = 0 \Rightarrow 400\text{ mA}$, $t_R = 0.5\ \mu\text{s}$

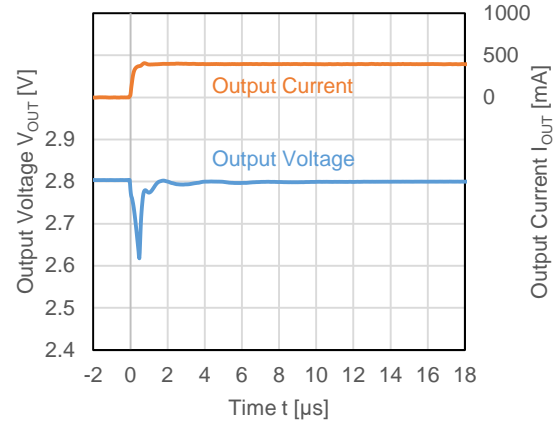

RP122x481x, $V_{IN} = 5.5\text{ V}$,
 $I_{OUT} = 1\text{ mA} \Leftrightarrow 250\text{ mA}$, $t_R = t_F = 10\ \mu\text{s}$

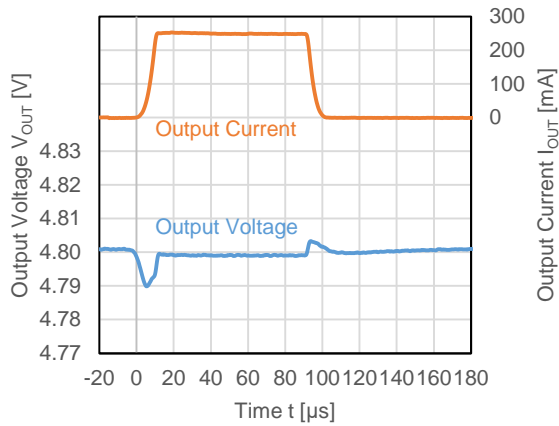

RP122x481x, $V_{IN} = 5.5\text{ V}$,
 $I_{OUT} = 0 \Rightarrow 400\text{ mA}$, $t_R = 0.5\ \mu\text{s}$

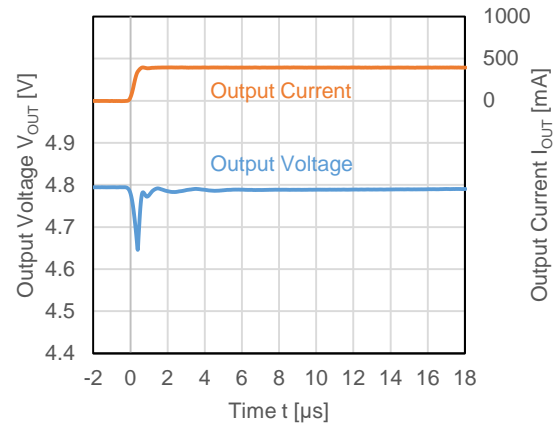

15) Turn On Speed with CE Pin ($C_{IN} = \text{Ceramic } 1.0\ \mu\text{F}$, $C_{OUT} = \text{Ceramic } 1.0\ \mu\text{F}$, $T_a = 25^\circ\text{C}$)

RP122x121x, $V_{IN} = 2.2\text{ V}$

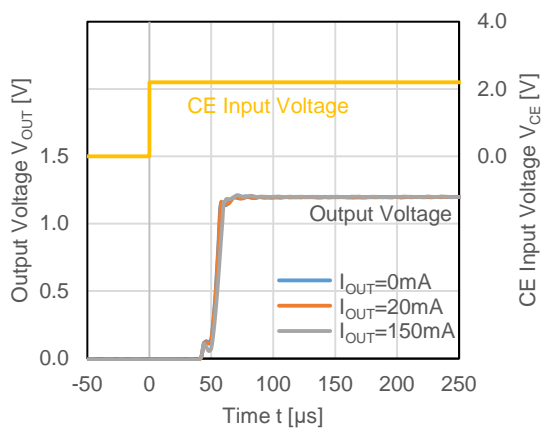

RP122x281x, $V_{IN} = 3.8\text{ V}$

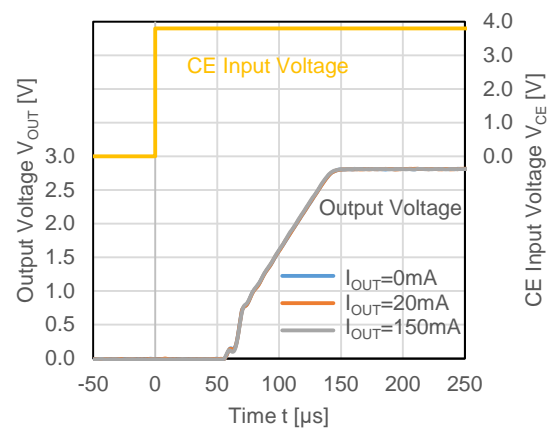

RP122x481x, $V_{IN} = 5.5V$

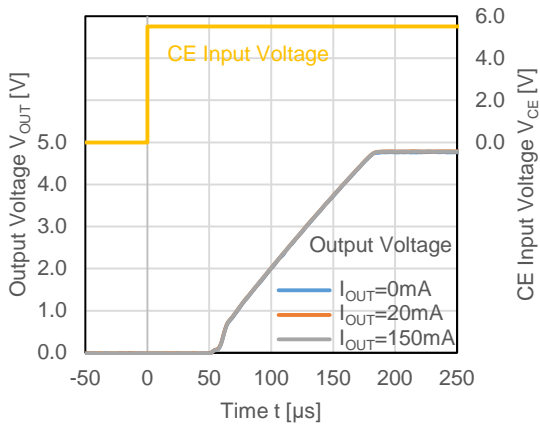

16) Turn Off Speed with CE Pin ($C_{IN} = \text{Ceramic } 1.0 \mu F, C_{OUT} = \text{Ceramic } 1.0 \mu F, T_a = 25^\circ C$)

RP122x121D, $V_{IN} = 2.2V$

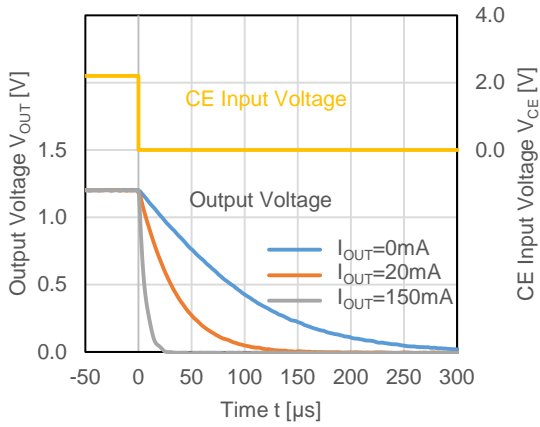

RP122x281D, $V_{IN} = 3.8V$

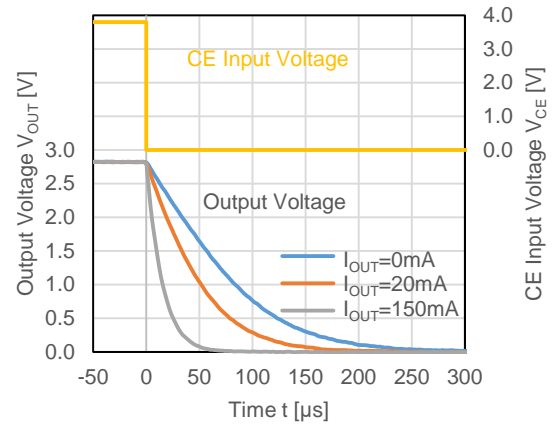

RP122x481D, $V_{IN} = 5.5V$

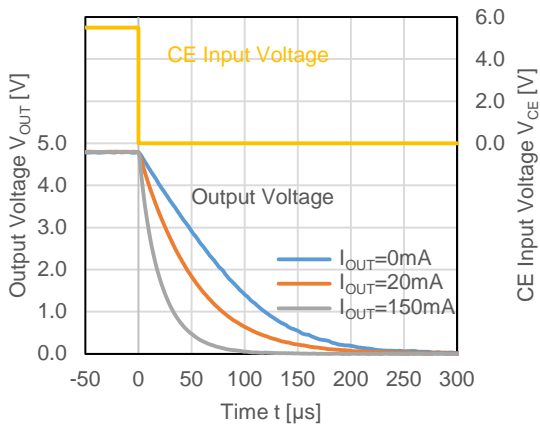

17) Inrush Current (C_{IN} = Ceramic $1.0 \mu\text{F}$, I_{OUT} = 0 mA , T_a = 25°C)

RP122x121x, V_{IN} = 2.2 V

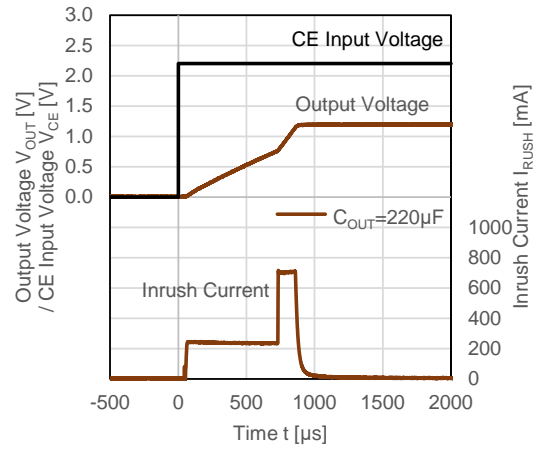
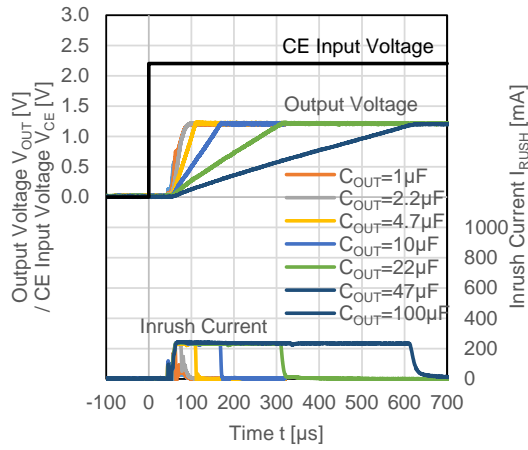

RP122x281x, V_{IN} = 3.8 V

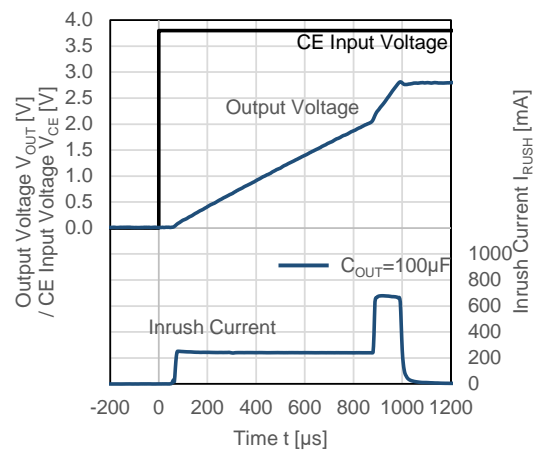
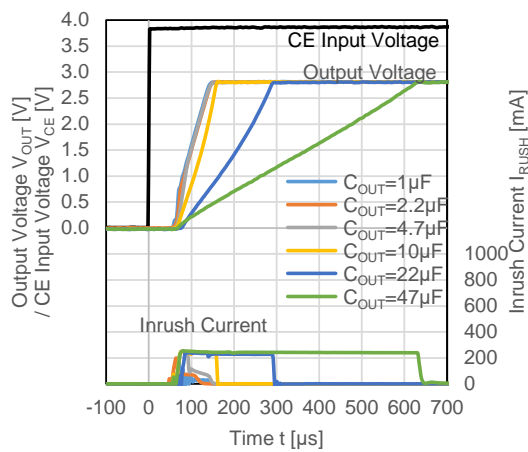

RP122x481x, V_{IN} = 5.5 V

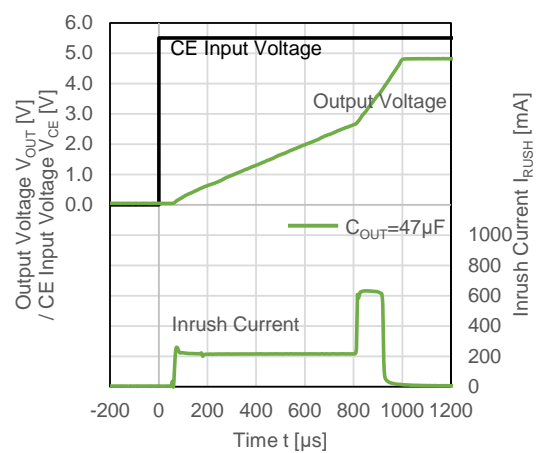
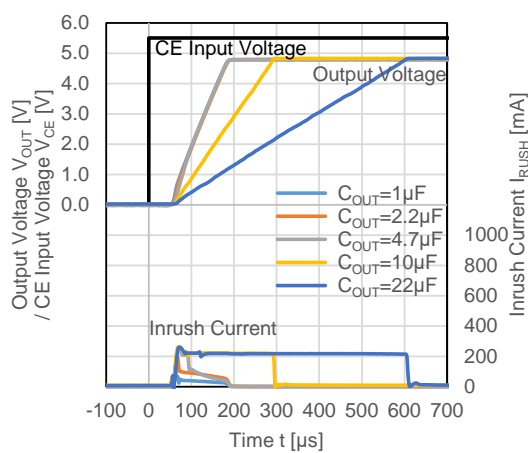

The power dissipation of the package is dependent on PCB material, layout, and environmental conditions. The following measurement conditions are based on JEDEC STD. 51-9.

Measurement Conditions

Item	Measurement Conditions
Environment	Mounting on Board (Wind Velocity = 0 m/s)
Board Material	Glass Cloth Epoxy Plastic (Four-Layer Board)
Board Dimensions	101.5 mm x 114.5 mm x 1.6 mm
Copper Ratio	Outer Layer (First Layer): 60% Inner Layers (Second and Third Layers): 100% Outer Layer (Fourth Layer): 60%

Measurement Result

(Ta = 25°C, Tjmax = 125°C)

Item	Measurement Result
Power Dissipation	520 mW
Thermal Resistance (θ_{ja})	$\theta_{ja} = 192^\circ\text{C/W}$

θ_{ja} : Junction-to-Ambient Thermal Resistance

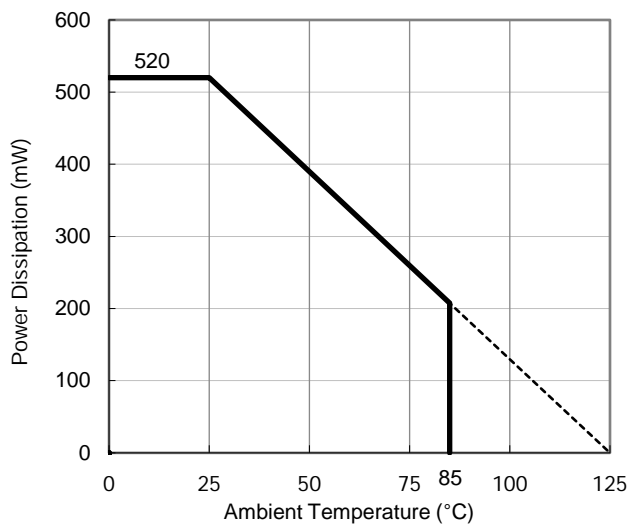

Power Dissipation vs. Ambient Temperature

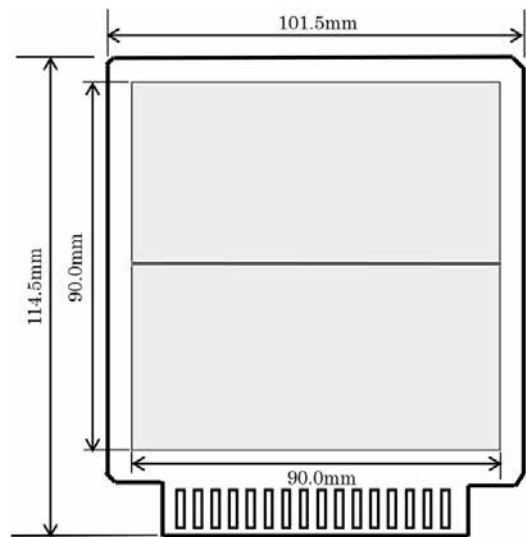

Measurement Board Pattern

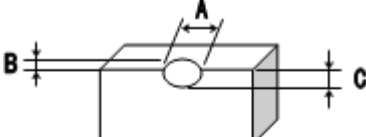
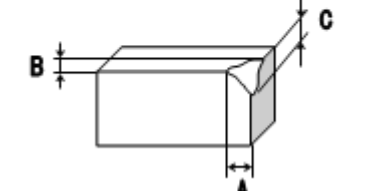
No.	Inspection Items	Inspection Criteria	Figure
1	Package chipping	<p>$A \geq 0.2\text{mm}$ is rejected $B \geq 0.2\text{mm}$ is rejected $C \geq 0.2\text{mm}$ is rejected And, Package chipping to Si surface and to bump is rejected.</p>	
2	Si surface chipping	<p>$A \geq 0.2\text{mm}$ is rejected $B \geq 0.2\text{mm}$ is rejected $C \geq 0.2\text{mm}$ is rejected But, even if $A \geq 0.2\text{mm}$, $B \leq 0.1\text{mm}$ is acceptable.</p>	
3	No bump	No bump is rejected.	
4	Marking miss	To reject incorrect marking, such as another product name marking or another lot No. marking.	
5	No marking	To reject no marking on the package.	
6	Reverse direction of marking	To reject reverse direction of marking character.	
7	Defective marking	To reject unreadable marking. (Microscope: X15/ White LED/ Viewed from vertical direction)	
8	Scratch	To reject unreadable marking character by scratch. (Microscope: X15/ White LED/ Viewed from vertical direction)	
9	Stain and Foreign material	To reject unreadable marking character by stain and foreign material. (Microscope: X15/ White LED/ Viewed from vertical direction)	

The power dissipation of the package is dependent on PCB material, layout, and environmental conditions. The following measurement conditions are based on JEDEC STD. 51-7.

Measurement Conditions

Item	Measurement Conditions
Environment	Mounting on Board (Wind Velocity = 0 m/s)
Board Material	Glass Cloth Epoxy Plastic (Four-Layer Board)
Board Dimensions	76.2 mm × 114.3 mm × 0.8 mm
Copper Ratio	Outer Layer (First Layer): Less than 95% of 50 mm Square Inner Layers (Second and Third Layers): Approx. 100% of 50 mm Square Outer Layer (Fourth Layer): Approx. 100% of 50 mm Square
Through-holes	φ 0.2 mm × 11 pcs

Measurement Result

(Ta = 25°C, Tjmax = 125°C)

Item	Measurement Result
Power Dissipation	550 mW
Thermal Resistance (θja)	θja = 180°C/W
Thermal Characterization Parameter (ψjt)	ψjt = 105°C/W

θja: Junction-to-Ambient Thermal Resistance

ψjt: Junction-to-Top Thermal Characterization Parameter

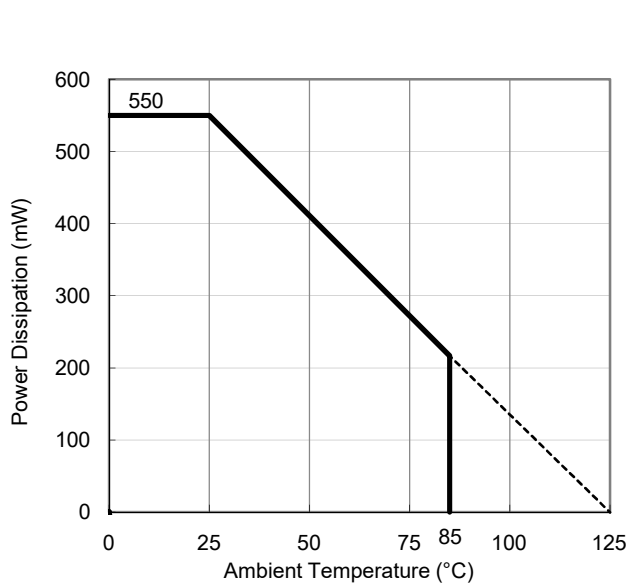

Power Dissipation vs. Ambient Temperature

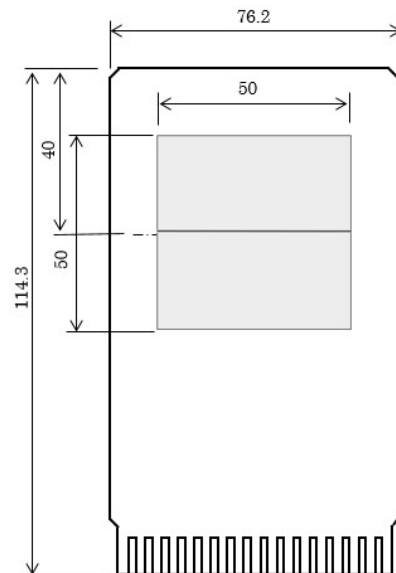

Measurement Board Pattern

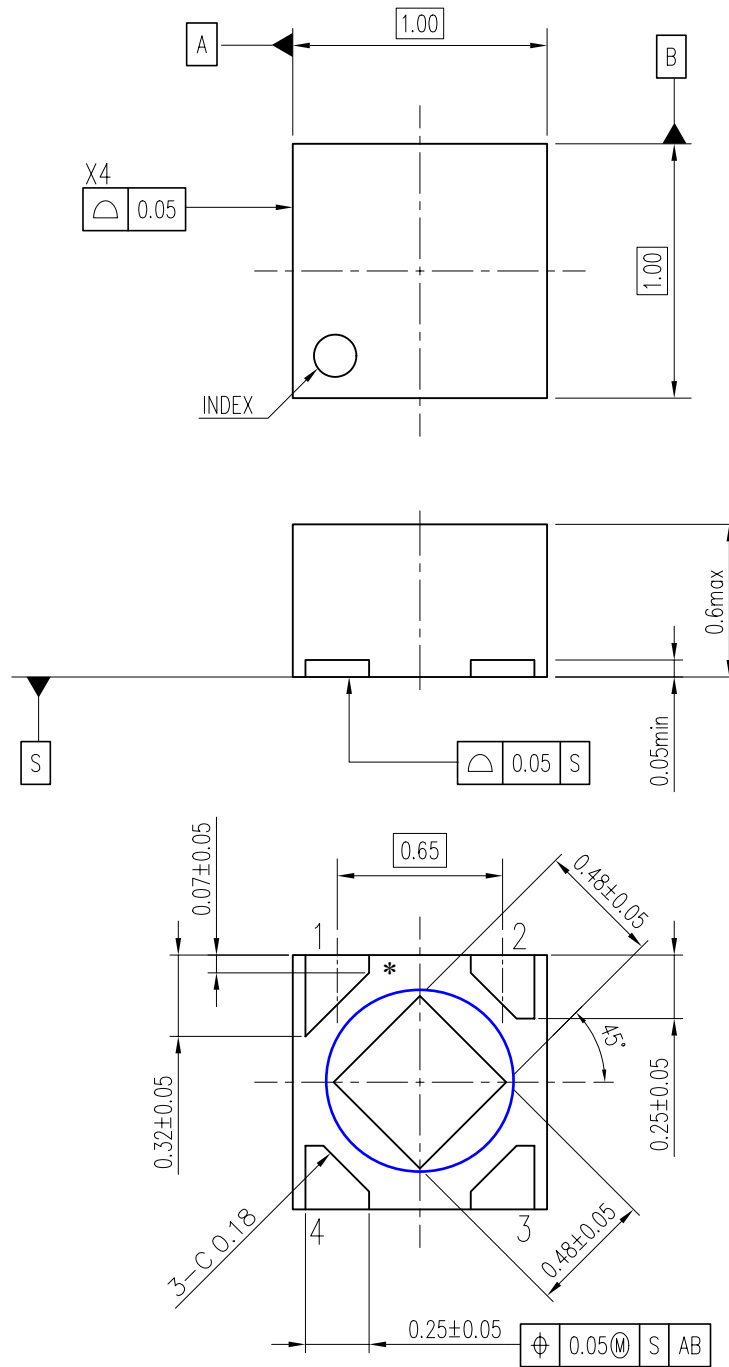

DFN(PLP)1010-4 Package Dimensions (Unit: mm)

* The tab on the bottom of the package shown by blue circle is a substrate potential (GND). It is recommended that this tab be connected to the ground plane on the board but it is possible to leave the tab floating.



1. The products and the product specifications described in this document are subject to change or discontinuation of production without notice for reasons such as improvement. Therefore, before deciding to use the products, please refer to Ricoh sales representatives for the latest information thereon.
2. The materials in this document may not be copied or otherwise reproduced in whole or in part without prior written consent of Ricoh.
3. Please be sure to take any necessary formalities under relevant laws or regulations before exporting or otherwise taking out of your country the products or the technical information described herein.
4. The technical information described in this document shows typical characteristics of and example application circuits for the products. The release of such information is not to be construed as a warranty of or a grant of license under Ricoh's or any third party's intellectual property rights or any other rights.
5. The products listed in this document are intended and designed for use as general electronic components in standard applications (office equipment, telecommunication equipment, measuring instruments, consumer electronic products, amusement equipment etc.). Those customers intending to use a product in an application requiring extreme quality and reliability, for example, in a highly specific application where the failure or misoperation of the product could result in human injury or death (aircraft, spacevehicle, nuclear reactor control system, traffic control system, automotive and transportation equipment, combustion equipment, safety devices, life support system etc.) should first contact us.
6. We are making our continuous effort to improve the quality and reliability of our products, but semiconductor products are likely to fail with certain probability. In order to prevent any injury to persons or damages to property resulting from such failure, customers should be careful enough to incorporate safety measures in their design, such as redundancy feature, fire containment feature and fail-safe feature. We do not assume any liability or responsibility for any loss or damage arising from misuse or inappropriate use of the products.
7. Anti-radiation design is not implemented in the products described in this document.
8. The X-ray exposure can influence functions and characteristics of the products. Confirm the product functions and characteristics in the evaluation stage.
9. WLCSP products should be used in light shielded environments. The light exposure can influence functions and characteristics of the products under operation or storage.
10. There can be variation in the marking when different AOI (Automated Optical Inspection) equipment is used. In the case of recognizing the marking characteristic with AOI, please contact Ricoh sales or our distributor before attempting to use AOI.
11. Please contact Ricoh sales representatives should you have any questions or comments concerning the products or the technical information.



Ricoh is committed to reducing the environmental loading materials in electrical devices with a view to contributing to the protection of human health and the environment.

Ricoh has been providing RoHS compliant products since April 1, 2006 and Halogen-free products since April 1, 2012.

RICOH RICOH ELECTRONIC DEVICES CO., LTD.

Official website

<https://www.n-redc.co.jp/en/>

Contact us

<https://www.n-redc.co.jp/en/buy/>

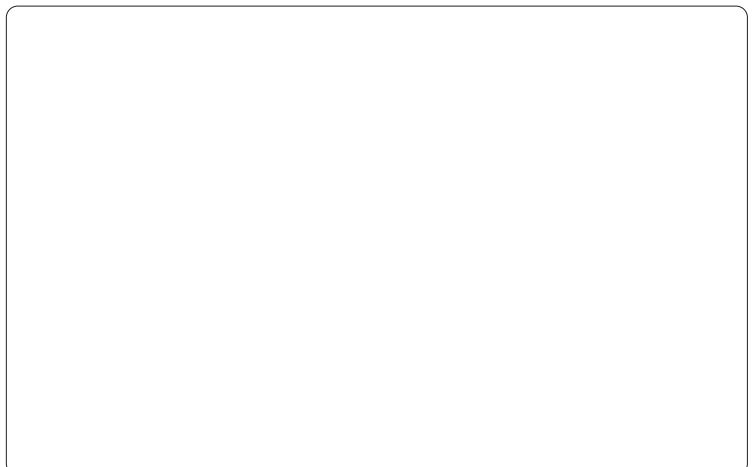

Mouser Electronics

Authorized Distributor

Click to View Pricing, Inventory, Delivery & Lifecycle Information:

Ricoh Electronics:

[RP122K291D-TR](#) [RP122K331D-TR](#) [RP122K311D-TR](#) [RP122K121D-TR](#) [RP122K281D-TR](#) [RP122K451D-TR](#)
[RP122K181D-TR](#) [RP122K281B-TR](#) [RP122K281D5-TR](#) [RP122K351D-TR](#) [RP122K411D-TR](#) [RP122K121B-TR](#)
[RP122K251B-TR](#) [RP122K461D-TR](#) [RP122K301B-TR](#) [RP122K331B-TR](#) [RP122K311B-TR](#) [RP122K251D-TR](#)
[RP122Z131D-TR-F](#) [RP122Z181D-TR-F](#) [RP122Z251D-TR-F](#) [RP122Z281D-TR-F](#) [RP122Z301D-TR-F](#) [RP122Z331D-TR-F](#)