



7.0 x 5.0 x 1.9mm

**AST3TQ-28**



**ESD Sensitive**



**RoHS/RoHS II Compliant**

**Moisture Sensitivity Level (MSL) – 3**

➤ **FEATURES:**

- Standard available frequencies: 10.00, 12.80, 15.36, 16.32, 16.384, 19.20, 19.44, 20.00, 25.00, 26.00, 30.72 & 40.00 MHz
- Standard LVC MOS Output
- Frequency stability of  $\pm 280$  ppb ( $\pm 0.28$  ppm) over  $-40^{\circ}\text{C}$  to  $+85^{\circ}\text{C}$
- Excellent Phase Noise, Harmonics & Spurious content
- Typical rms jitter of 400fs @ 40MHz carrier & 1.0ps @ 10MHz carrier over 12kHz to 20MHz BW

➤ **APPLICATIONS:**

- COTS Military Radios & other Communication Hardware
- WiMax,
- LTE, BTS
- CATV, LAN, LMDS
- GPS Tracking with Hold-Over accuracy
- Test & Measurement Equipment
- Point-to-Point communication networks

➤ **STANDARD SPECIFICATIONS:**

Parameters	Rating
Storage Temperature Range	-55 to +125°C
Supply Voltage	-0.5 to 6V
ESD, HBM/CDM/MM	4kV/2kV/200V

Parameters	Minimum	Typical	Maximum	Units	Notes
Frequency Range	10		40	MHz	
Standard Frequencies:	10.00, 12.80, 15.36, 16.32, 16.384, 19.20, 19.44, 20.00, 25.00, 26.00, 30.72 and 40.00			MHz	
Initial Frequency Tolerance (@+25°C) at shipping			$\pm 0.3$	ppm	Relative to carrier
<b>Frequency Stability Options</b>					
-40°C to +85°C			$\pm 280$	ppb	
Frequency Stability vs. Supply Voltage Change (V <sub>dd</sub> ±5%):			$\pm 100$	ppb	
Frequency Stability vs. Load Change (Load±5%):			$\pm 200$	ppb	
Supply Voltage (V <sub>dd</sub> ):	+3.135	+3.3	+3.465	V	
Aging (first year @+25°C):			$\pm 1.0$	ppm	
Aging (20 years @+25°C):		$\pm 3.0$	$\pm 4.6$	ppm	
Supply Current (I <sub>cc</sub> ) (into 15pF load):		3.0	4.0	mA	@10MHz carrier
			5.5		7.0
<b>LVC MOS Output (Square wave)</b>					
V <sub>OH</sub> :	2.4			V	Load=15pF
V <sub>OL</sub> :			0.4	V	Load=15pF
Load:			15	pF	
Duty Cycle:	45		55	%	@(V <sub>OH</sub> - V <sub>OL</sub> )/2
Rise/Fall Time:			6	ns	Load=15pF
RMS Jitter (12kHz to 20MHz BW)	0.4		1.3	ps	Carrier dependent
Control Port					<i>Applicable for VCTCXO only</i>
Voltage Range (V <sub>c</sub> )	0.50		+2.50	V	
Frequency Pull	$\pm 7.00$	$\pm 10.00$	$\pm 12.00$	ppm	(V <sub>c</sub> = 1.5V±1.0V)
Center Control Voltage (V <sub>c</sub> )		+1.50			To be with-in $\pm 500$ ppb of F <sub>c</sub> @ 25°C
Port Impedance	100			kΩ	
Phase Noise (10MHz carrier frequency @25°C):			-95	dBc/Hz	Offset @10Hz
			-120		Offset @100Hz
			-140		Offset @1kHz
			-145		Offset @10kHz
			-150		Offset @100kHz



7.0 x 5.0 x 1.9mm

AST3TQ-28

RoHS/RoHS II Compliant

## OPTIONS & PART IDENTIFICATION: (left blank if standard)

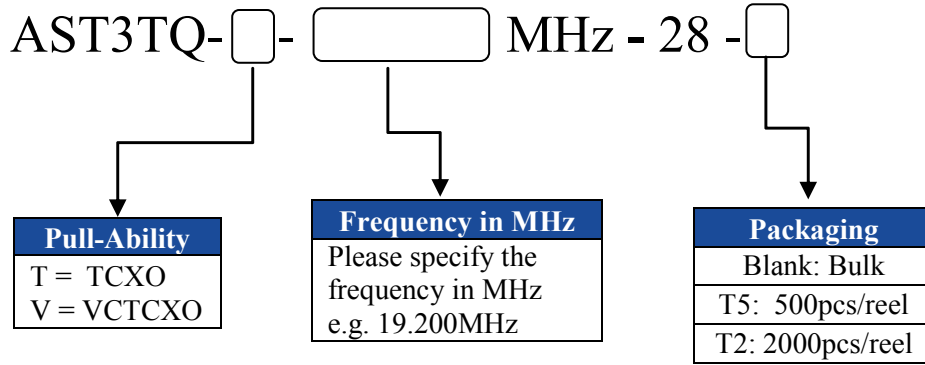

## FREQUENCY STABILITY VS. TEMPERATURE

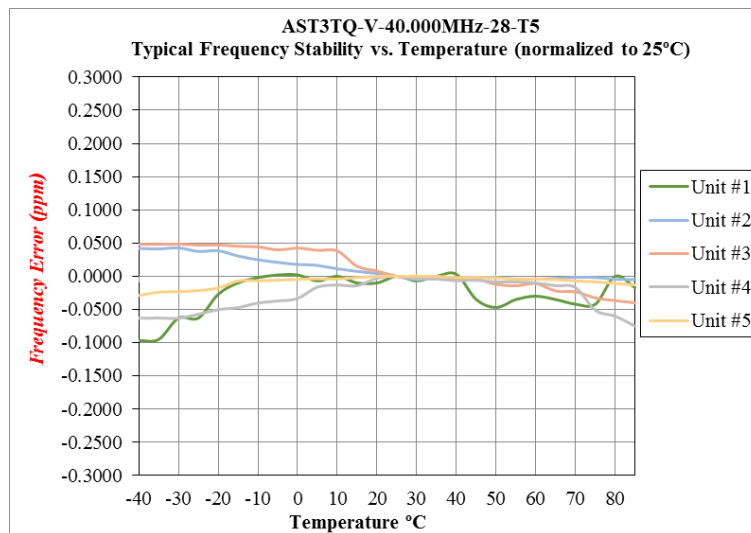



7.0 x 5.0 x 1.9mm

### TYPICAL PHASE NOISE

#### 10.00 MHz Carrier



#### 20.00 MHz Carrier



#### 40.00 MHz Carrier





AST3TQ-28

7.0 x 5.0 x 1.9mm

AST3TQ-28

 RoHS/RoHS II Compliant

## Typical Allan Deviation Performance @10.00MHz carrier

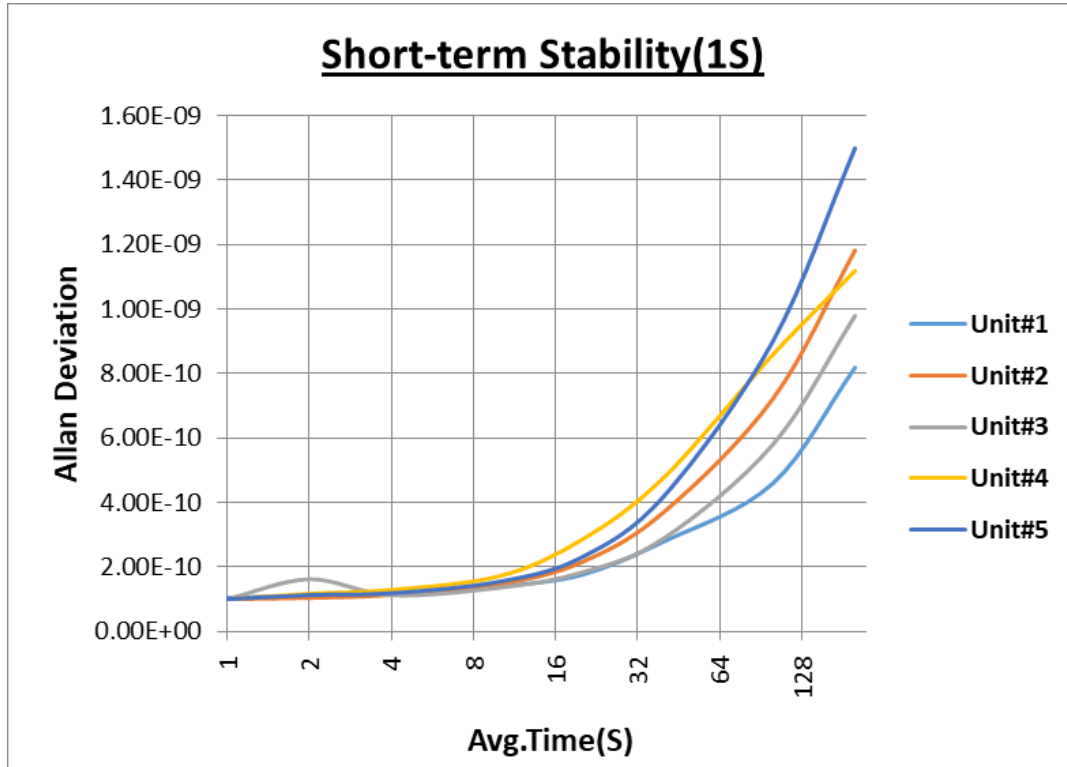



7.0 x 5.0 x 1.9mm

AST3TQ-28

RoHS/RoHS II Compliant

## OUTLINE DIMENSION:

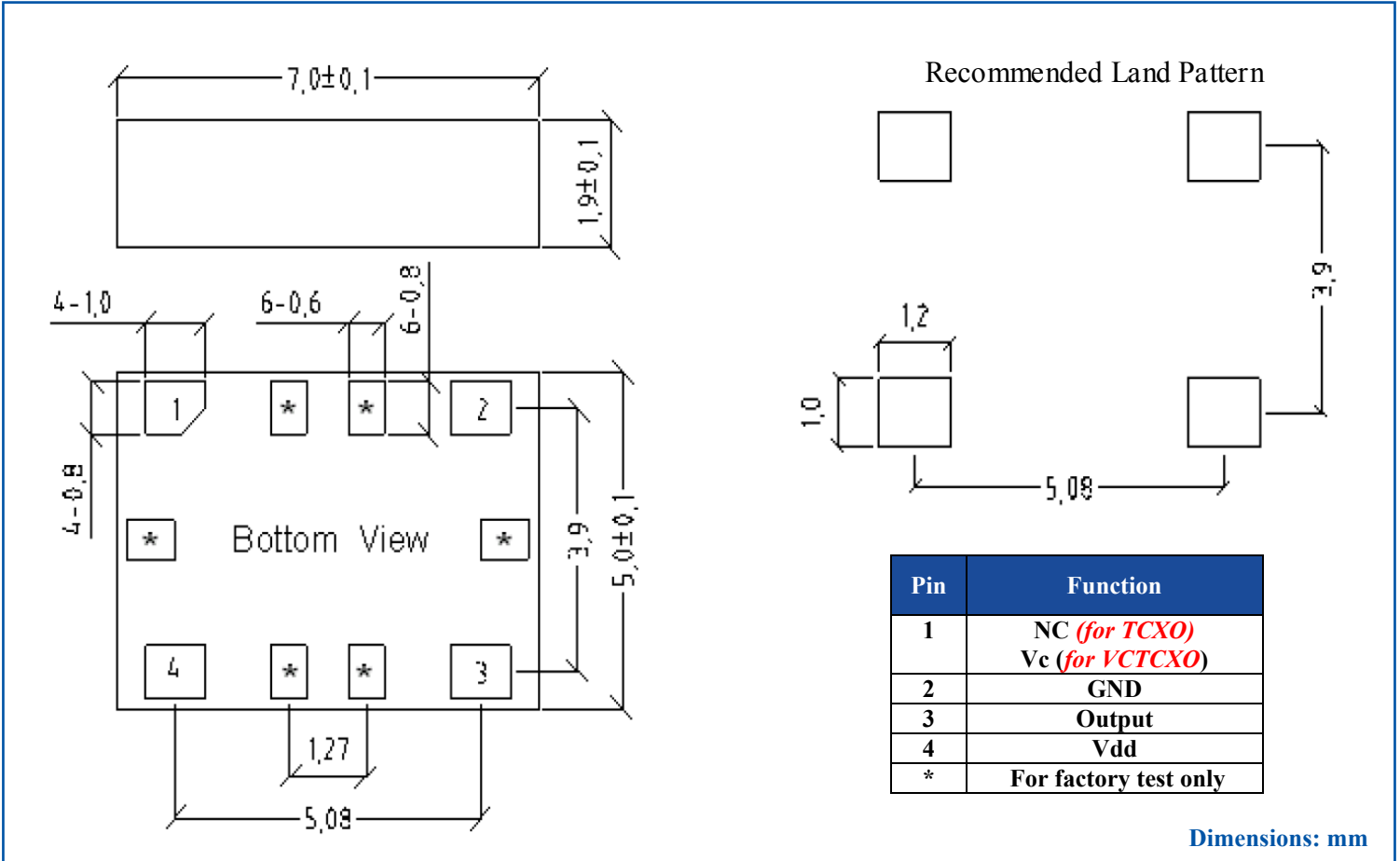

## REFLOW PROFILE:

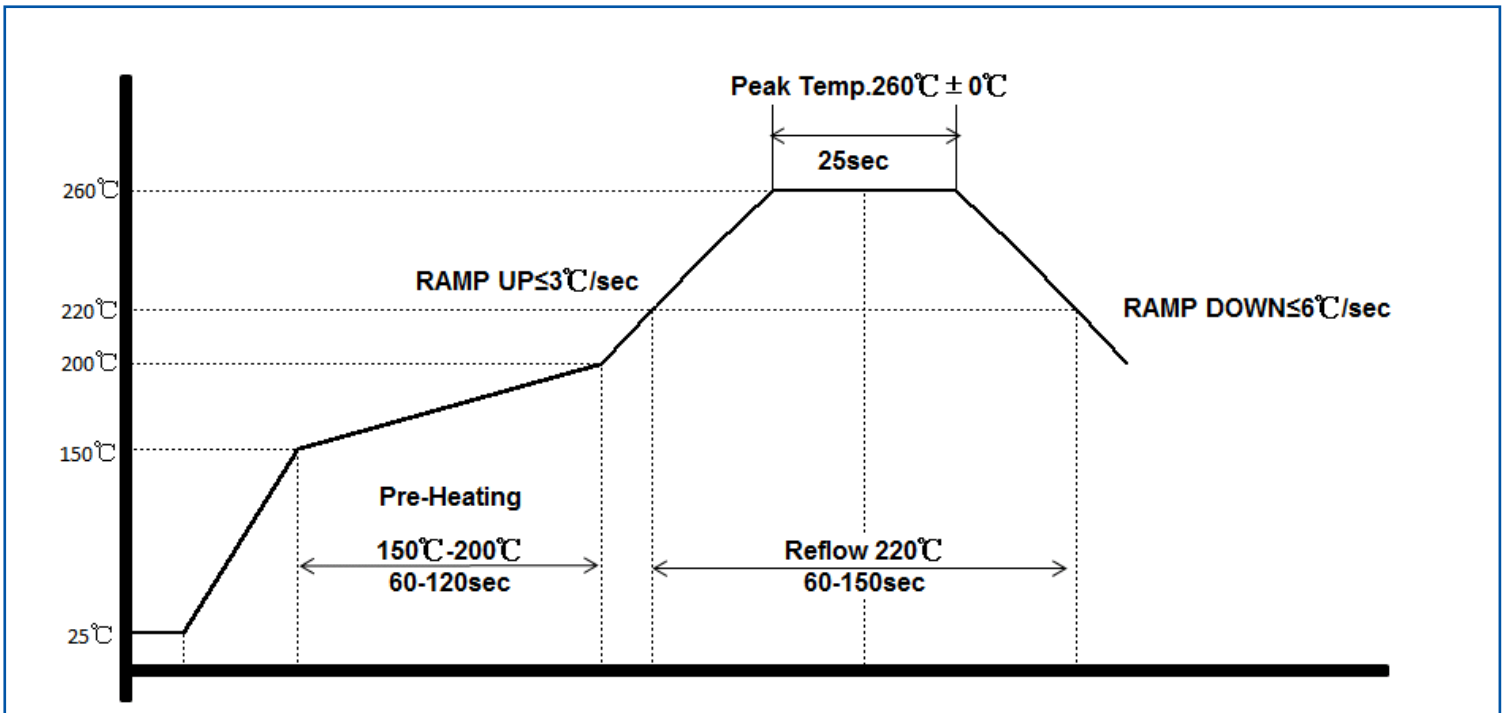



AST3TQ-28

7.0 x 5.0 x 1.9mm

AST3TQ-28

RoHS/RoHS II Compliant

## TAPE & REEL:

### Packaging:

T5: 500pcs/reel

T2: 2,000pcs/reel

**MSL-3 packaging applies to MOQ=50 units (cut tape) & T5 and T2.**

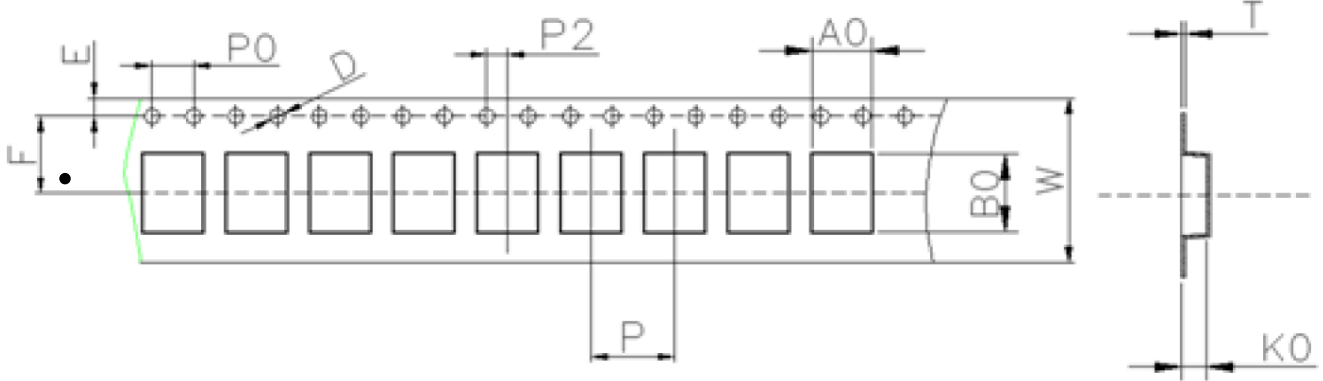

W	A0	B0	K0	P	F
16.0±0.3	5.7±0.15	7.6±0.15	2.4±0.15	8.0±0.1	7.5±0.1
E	D	P0	P2	T	
1.75±0.1	1.5+0.1/-0.0	4.0±0.1	2.0±0.1	0.3±0.05	

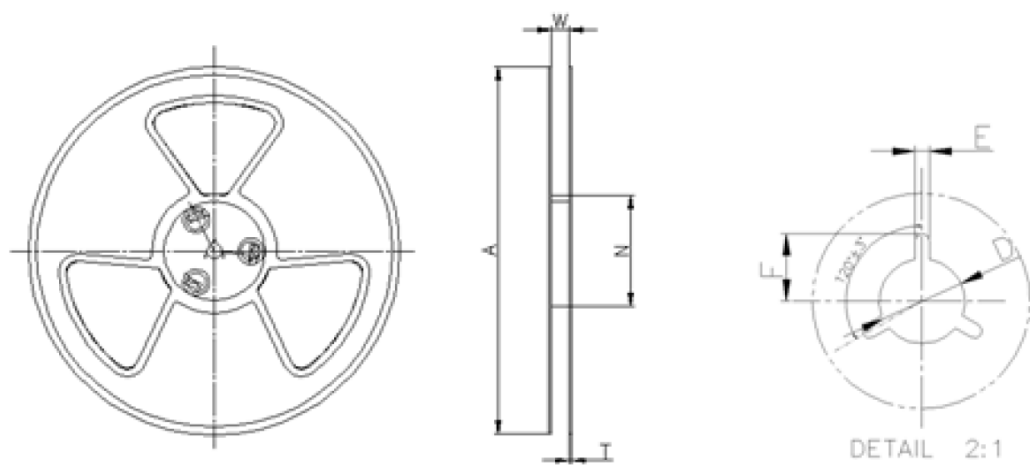

W	A	N	T	E	F	D
16.5±0.4	330±0.5	100±0.3	1.8±0.2	2.1±0.3	10.75±0.3	13.5+0.5/-0.2

Dimensions: mm

**ATTENTION:** Abracon LLC's products are COTS – Commercial-Off-The-Shelf products; suitable for Commercial, Industrial and, where designated, Automotive Applications. Abracon's products are not specifically designed for Military, Aviation, Aerospace, Life-dependent Medical applications or any application requiring high reliability where component failure could result in loss of life and/or property. For applications requiring high reliability and/or presenting an extreme operating environment, written consent and authorization from Abracon LLC is required. Please contact Abracon LLC for more information.

# Mouser Electronics

Authorized Distributor

Click to View Pricing, Inventory, Delivery & Lifecycle Information:

## ABRACON:

[AST3TQ-V-25.000MHz-28](#) [AST3TQ-V-40.000MHz-28](#) [AST3TQ-T-25.000MHz-28-T2](#) [AST3TQ-V-10.000MHz-28](#)  
[AST3TQ-T-26.000MHz-28-T5](#) [AST3TQ-T-20.000MHz-28-T5](#) [AST3TQ-V-19.200MHz-28-T5](#) [AST3TQ-V-12.800MHz-28-T2](#)  
[AST3TQ-T-40.000MHz-28-T5](#) [AST3TQ-T-12.800MHz-28](#) [AST3TQ-T-16.320MHz-28-T2](#) [AST3TQ-T-40.000MHz-28-T2](#)  
[AST3TQ-T-16.384MHz-28-T5](#) [AST3TQ-T-20.000MHz-28](#) [AST3TQ-T-16.320MHz-28-T5](#) [AST3TQ-T-16.384MHz-28-T2](#)  
[AST3TQ-T-26.000MHz-28-T2](#) [AST3TQ-T-12.800MHz-28-T5](#) [AST3TQ-V-16.384MHz-28](#) [AST3TQ-T-25.000MHz-28-T5](#)  
[AST3TQ-V-19.440MHz-28](#) [AST3TQ-T-19.200MHz-28-T5](#) [AST3TQ-T-26.000MHz-28](#) [AST3TQ-V-16.384MHz-28-T5](#)  
[AST3TQ-V-10.000MHz-28-T5](#) [AST3TQ-T-20.000MHz-28-T2](#) [AST3TQ-V-20.000MHz-28-T2](#) [AST3TQ-V-16.320MHz-28-T5](#)  
[AST3TQ-V-15.360MHz-28](#) [AST3TQ-T-19.200MHz-28-T2](#) [AST3TQ-V-15.360MHz-28-T5](#) [AST3TQ-T-30.720MHz-28-T2](#)  
[AST3TQ-T-16.320MHz-28](#) [AST3TQ-T-30.720MHz-28](#) [AST3TQ-T-19.200MHz-28](#) [AST3TQ-T-40.000MHz-28](#)  
[AST3TQ-V-16.384MHz-28-T2](#) [AST3TQ-V-30.720MHz-28](#) [AST3TQ-V-19.200MHz-28](#) [AST3TQ-V-19.200MHz-28-T2](#)  
[AST3TQ-V-30.720MHz-28-T2](#) [AST3TQ-T-19.440MHz-28-T2](#) [AST3TQ-T-16.384MHz-28](#) [AST3TQ-V-20.000MHz-28-T5](#)  
[AST3TQ-T-15.360MHz-28-T2](#) [AST3TQ-V-40.000MHz-28-T2](#) [AST3TQ-T-10.000MHz-28-T2](#) [AST3TQ-T-15.360MHz-28-T5](#)  
[AST3TQ-V-19.440MHz-28-T2](#) [AST3TQ-V-10.000MHz-28-T2](#) [AST3TQ-V-40.000MHz-28-T5](#) [AST3TQ-V-20.000MHz-28](#)  
[AST3TQ-V-16.320MHz-28-T2](#) [AST3TQ-T-10.000MHz-28](#) [AST3TQ-T-15.360MHz-28](#) [AST3TQ-T-30.720MHz-28-T5](#)  
[AST3TQ-V-30.720MHz-28-T5](#) [AST3TQ-T-19.440MHz-28](#) [AST3TQ-V-16.320MHz-28](#) [AST3TQ-V-26.000MHz-28](#)  
[AST3TQ-V-25.000MHz-28-T2](#) [AST3TQ-V-26.000MHz-28-T2](#) [AST3TQ-V-12.800MHz-28](#) [AST3TQ-T-12.800MHz-28-T2](#)  
[AST3TQ-V-26.000MHz-28-T5](#) [AST3TQ-V-12.800MHz-28-T5](#) [AST3TQ-V-15.360MHz-28-T2](#) [AST3TQ-V-19.440MHz-28-T5](#)  
[AST3TQ-T-25.000MHz-28](#) [AST3TQ-T-10.000MHz-28-T5](#) [AST3TQ-T-19.440MHz-28-T5](#) [AST3TQ-V-25.000MHz-28-T5](#)  
[AST3TQ-19.200MHz-2-T2](#) [AST3TQ-26.000MHz-2-T2](#)