



Glass Passivated Three Phase Rectifier Bridge

VRRM 800 to 1800V
ID 75 A

Applications

- Three phase rectifiers for power supplies
- Rectifiers for DC motor field supplies
- Battery charger rectifiers
- Input rectifiers for variable frequency drives

Features

- Three phase bridge rectifier
- Blocking voltage:800 to 1800V
- Heat transfer through aluminum oxide DBC ceramic isolated metal baseplate
- Glass passivated chip
- UL recognized applied for file no. E360040

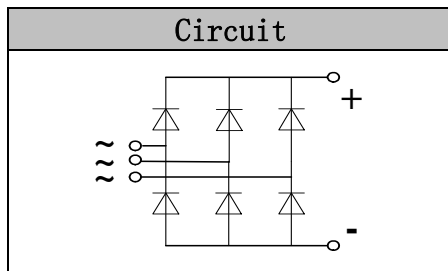

Module Type

TYPE	VRRM	VRSM
MD75S08M2	800V	900V
MD75S12M2	1200V	1300V
MD75S16M2	1600V	1700V
MD75S18M2	1800V	1900V

Maximum Ratings

Symbol	Conditions	Values	Units
I_D	Three phase, full wave $T_c=110^\circ\text{C}$	75	A
I_{FSM}	$t=10\text{ms}$ $T_{vj}=45^\circ\text{C}$	750	A
i^2t	$t=10\text{ms}$ $T_{vj}=45^\circ\text{C}$	2800	A^2s
V_{isol}	a.c.50HZ;r.m.s.;1min	3000	V
T_{vj}		-40 to +150	$^\circ\text{C}$
T_{stg}		-40 to +125	$^\circ\text{C}$
M_t	To terminals(M5)	$5\pm 15\%$	Nm
M_s	To heatsink(M5)	$5\pm 15\%$	Nm
Weight	Module (Approximately)	130	g

Thermal Characteristics

Symbol	Conditions	Values	Units
$R_{th(j-c)}$	Per diode	1.1	$^\circ\text{C/W}$
$R_{th(c-s)}$	Module (Approximately)	0.07	$^\circ\text{C/W}$

Electrical Characteristics

Symbol	Conditions	Values			Units
		Min.	Typ.	Max.	
V_{FM}	$T=25^\circ\text{C}$ $I_F=150\text{A}$	—	1.38	1.60	V
I_{RD}	$T_{vj}=25^\circ\text{C}$ $V_{RD}=V_{RRM}$	—	—	0.3	mA
	$T_{vj}=150^\circ\text{C}$ $V_{RD}=V_{RRM}$	—	—	5	mA



Performance Curves

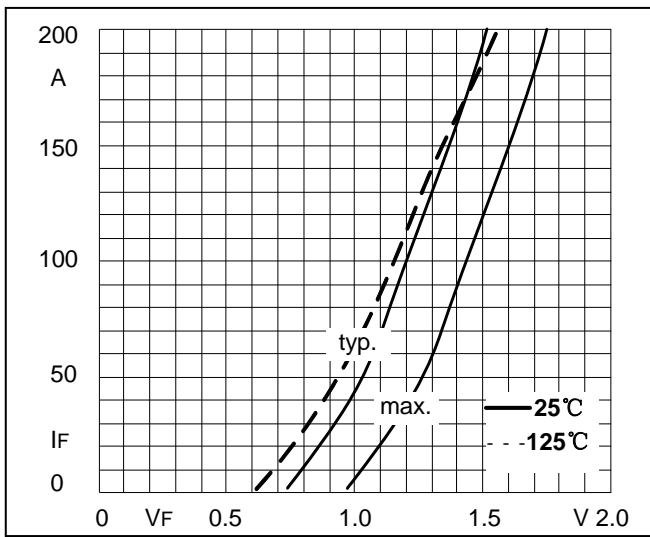

Fig1. Forward Characteristics

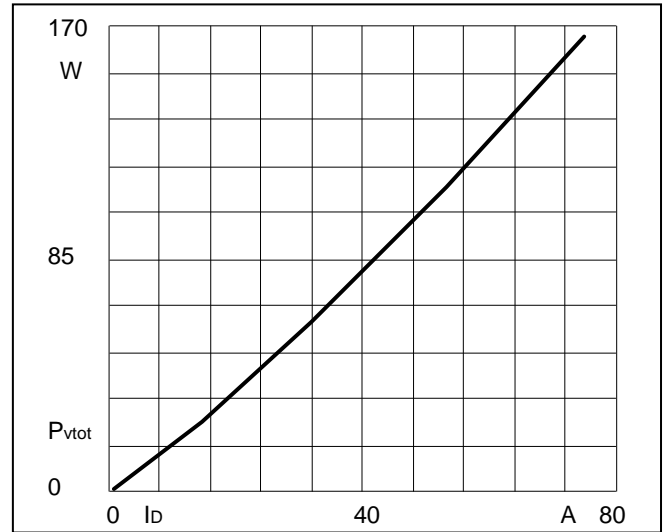

Fig2. Power dissipation

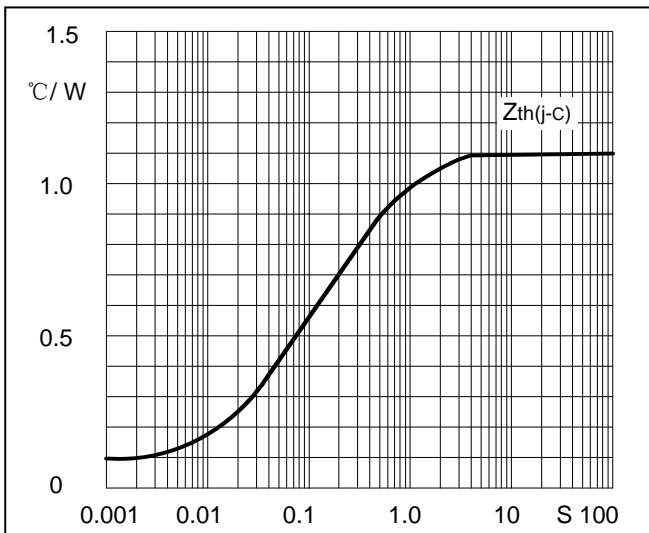

Fig3. Transient thermal impedance

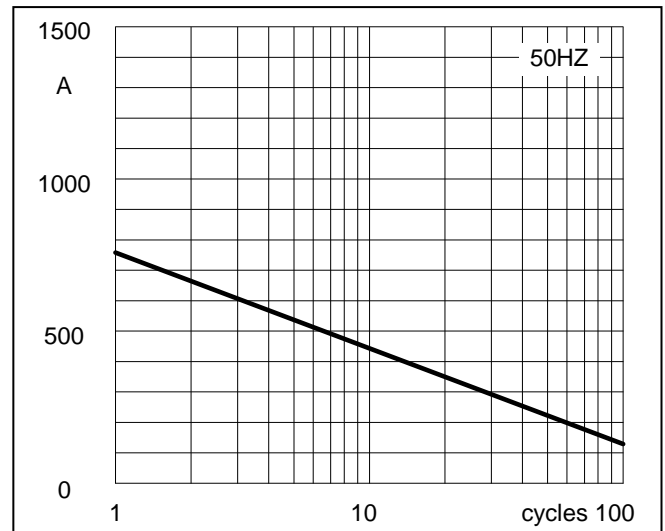

Fig4. Max Non-Repetitive Forward Surge Current

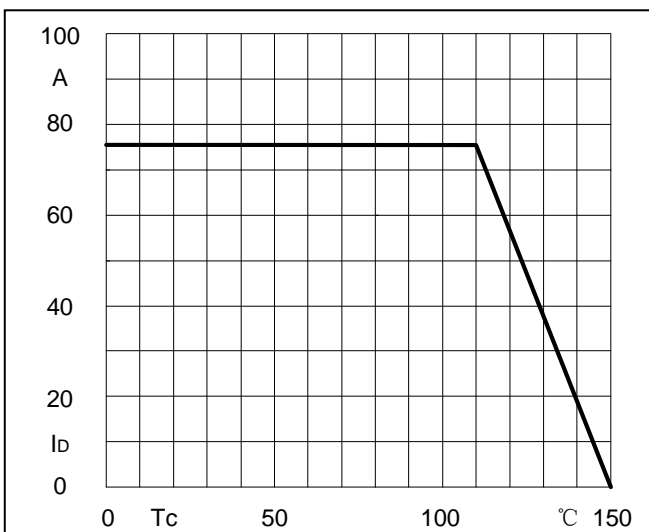
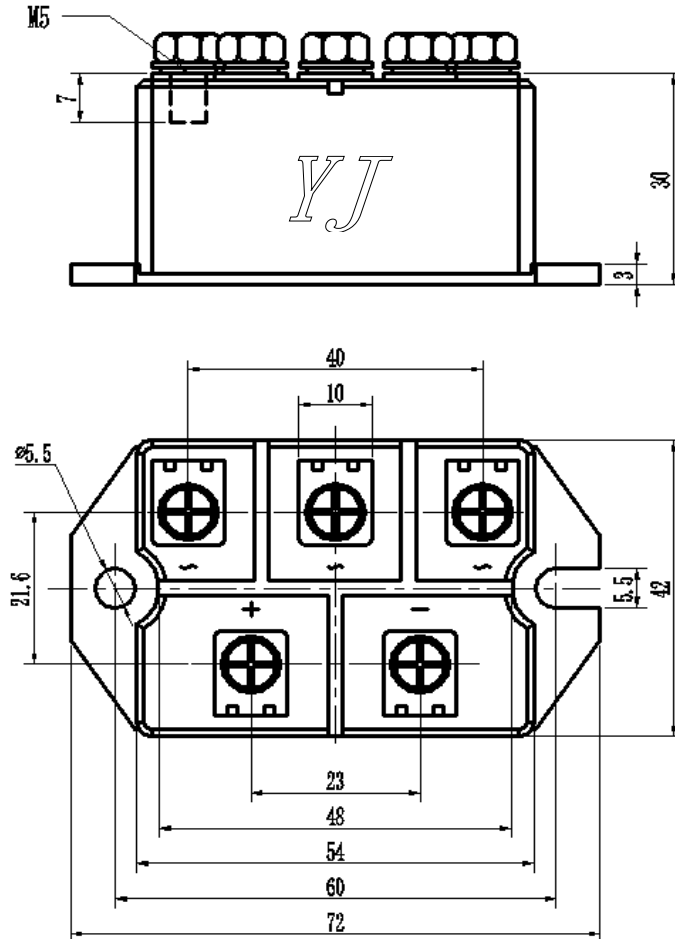

Fig5. Forward Current Derating Curve

Package Outline Information

CASE: M2



Dimensions in mm