

HCM1A1 105V2

Automotive grade high current power inductors



Product features

- AEC-Q200 qualified
- High current carrying capacity
- Magnetically shielded, low EMI
- DC-DC converter applications up to 1 MHz
- Filtering applications up to Self Resonant Frequency (SRF) [See product specification table]
- Inductance range from 0.68 μ H to 68 μ H
- Current range from 2.3 A to 30 A
- 11.2 mm x 10.3 mm footprint surface mount package in a 5.0 mm height
- Moisture Sensitivity Level (MSL): 1
- Alloy powder core material

Applications

- Body electronics
 - Central body control module
 - Headlamps, tail lamps and interior lighting and LED lighting
 - Heating ventilation and air conditioning controllers (HVAC)
 - Doors, window lift and seat control
- Advanced driver assistance systems
 - Adaptive cruise control (ACC)
 - Automatic parking control
 - Collision avoidance system/ Car black box system
- Infotainment and cluster electronics
 - Audio subsystem: head unit and trunk amp
 - Digital instrument cluster
 - In-vehicle infotainment (IVI) and navigation
 - Port power/USB HUB for front and rear passengers
- Chassis and safety electronics
 - Airbag control unit
 - Electronic stability control system (ESC)
 - Electric parking brake
- Engine and Powertrain Systems
 - Electric pumps, motor control and auxiliaries
 - Powertrain control module (PCU)/ Engine Control unit (ECU)
 - Transmission Control Unit (TCU)

Environmental data

- Storage temperature range (Component): -55 °C to +155 °C
- Operating temperature range: -55 °C to +155 °C (ambient plus self-temperature rise)
- Solder reflow temperature: J-STD-020 (latest revision) compliant



Product specifications

| Part number ⁶ | OCL ¹ (μH) $\pm 20\%$ | FLL ² (μH) minimum | I_{rms}^3 (A) | I_{sat}^4 (A) | DCR (m Ω) typical @ +20 °C | DCR (m Ω) maximum @ +20 °C | SRF (MHz) typical | K-factor ⁵ |
|--------------------------|--|---|---------------------------|---------------------------|---------------------------------------|---------------------------------------|----------------------|-----------------------|
| HCM1A1105V2-R68-R | 0.68 | 0.44 | 24.5 | 30 | 1.65 | 1.93 | 57 | 283 |
| HCM1A1105V2-R72-R | 0.72 | 0.46 | 23 | 24 | 1.55 | 1.71 | 54 | 298 |
| HCM1A1105V2-R90-R | 0.90 | 0.58 | 22 | 23 | 1.74 | 2.02 | 42 | 262 |
| HCM1A1105V2-1R0-R | 1.0 | 0.64 | 20 | 24 | 2.10 | 2.40 | 44 | 218 |
| HCM1A1105V2-1R2-R | 1.2 | 0.77 | 21 | 21 | 2.10 | 2.40 | 37 | 222 |
| HCM1A1105V2-1R5-R | 1.5 | 0.96 | 16.5 | 20 | 2.90 | 3.34 | 31 | 232 |
| HCM1A1105V2-2R2-R | 2.2 | 1.41 | 14.5 | 19 | 3.90 | 4.49 | 24 | 161 |
| HCM1A1105V2-2R8-R | 2.8 | 1.79 | 12 | 18 | 5.20 | 6.00 | 21 | 122 |
| HCM1A1105V2-3R3-R | 3.3 | 2.11 | 9.5 | 16 | 9.23 | 10.7 | 18 | 96 |
| HCM1A1105V2-4R7-R | 4.7 | 3.01 | 8.5 | 13 | 11.7 | 13.5 | 14 | 90 |
| HCM1A1105V2-5R6-R | 5.6 | 3.58 | 8.0 | 12 | 14.0 | 16.5 | 13 | 98 |
| HCM1A1105V2-6R8-R | 6.8 | 4.35 | 7.0 | 10 | 17.1 | 20.0 | 11 | 70 |
| HCM1A1105V2-100-R | 10 | 6.40 | 6.2 | 7.0 | 22.0 | 27.0 | 9 | 74 |
| HCM1A1105V2-120-R | 12 | 7.68 | 5.0 | 8.0 | 31.2 | 35.9 | 9 | 56 |
| HCM1A1105V2-150-R | 15 | 9.60 | 4.7 | 7.0 | 34.7 | 40.3 | 7 | 65 |
| HCM1A1105V2-220-R | 22 | 14.1 | 4.0 | 6.0 | 52.3 | 61.0 | 5 | 42 |
| HCM1A1105V2-330-R | 33 | 21.1 | 3.5 | 3.5 | 70.0 | 84.0 | 4 | 44 |
| HCM1A1105V2-470-R | 47 | 30.1 | 3.0 | 3.0 | 97.6 | 117 | 3 | 35 |
| HCM1A1105V2-680-R | 68 | 43.5 | 2.3 | 4.0 | 160 | 211 | 3 | 25 |

- Open Circuit Inductance (OCL) Test Parameters: 100 kHz, 0.25 V_{rms}, 0.0 Adc, +25 °C
- Full Load Inductance (FLL) Test Parameters: 100 kHz, 0.25 V_{rms}, I_{sat}, +25 °C
- I_{rms}: DC current for an approximate temperature rise of 30 °C without core loss. Derating is necessary for AC currents. PCB layout, trace thickness and width, air-flow, and proximity of other heat generating components will affect the temperature rise. It is recommended that the temperature of the part not exceed +155 °C under worst case operating conditions verified in the end application.

- I_{sat}: Peak current for approximately 20% rolloff @ +25 °C
- K-factor: Used to determine B_{pp} for core loss (see graph), B_{p-p} = K * L * ΔI . B_{pp}: (Gauss), K: (K-factor from table), L: (Inductance in μH), ΔI (Peak to peak ripple current in Amps).
- Part Number Definition: HCM1A1105V2-xxx-R
HCM1A1105V2 = Product code and size
xxx= inductance value in μH , R= decimal point,
If no R is present then last character equals number of zeros
-R suffix = RoHS compliant

Dimensions (mm)

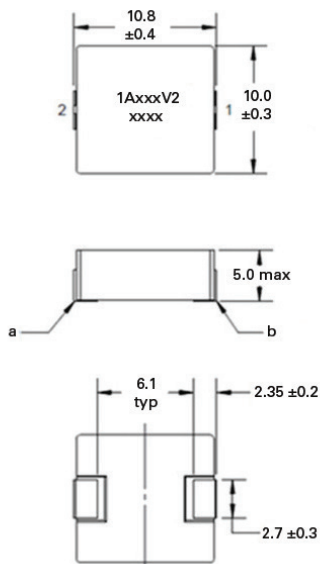

Recommended pad layout

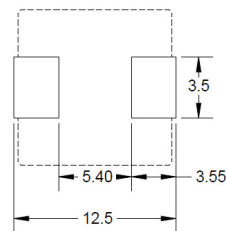

Schematic

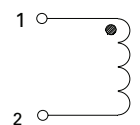

Part marking: 1AxxxV2, xxx=inductance value in μH , R=decimal point. If no R is present then last character equals number of zeros.
 xxxx=Lot code
 All soldering surfaces to be coplanar within 0.1 millimeters
 Tolerances are ± 0.3 millimeters unless stated otherwise
 Pad layout tolerances are ± 0.1 millimeters unless stated otherwise
 DCR measured from point "a" to point "b"
 Do not route traces or vias underneath the inductor

Packaging information (mm)

Drawing not to scale

Supplied in tape and reel packaging, 500 parts per 13" diameter reel

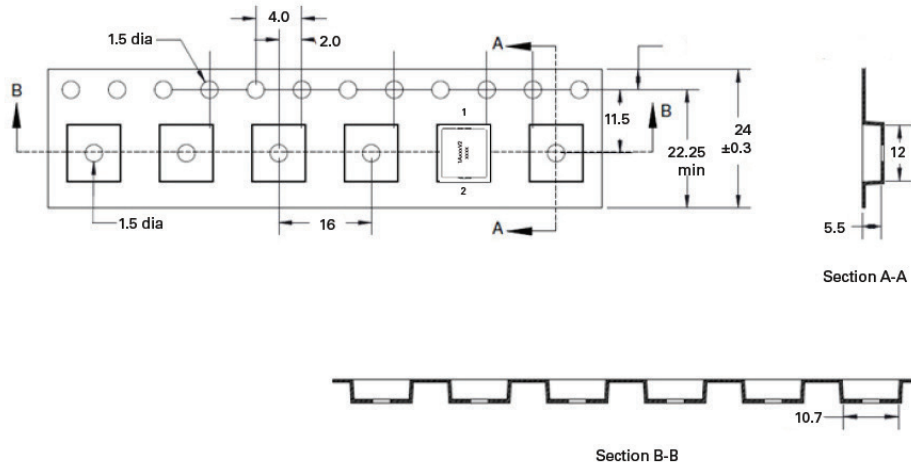

Core loss vs B_{p-p}

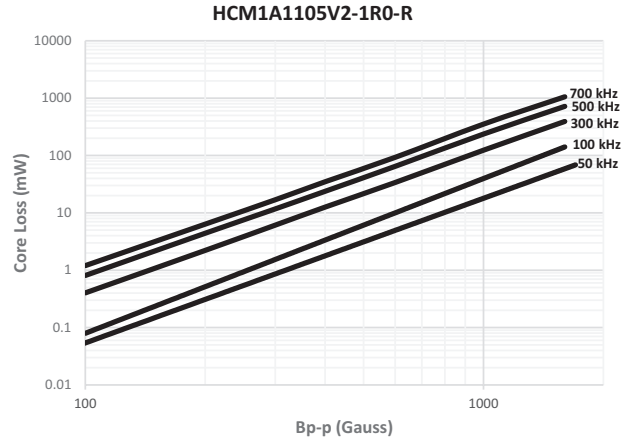
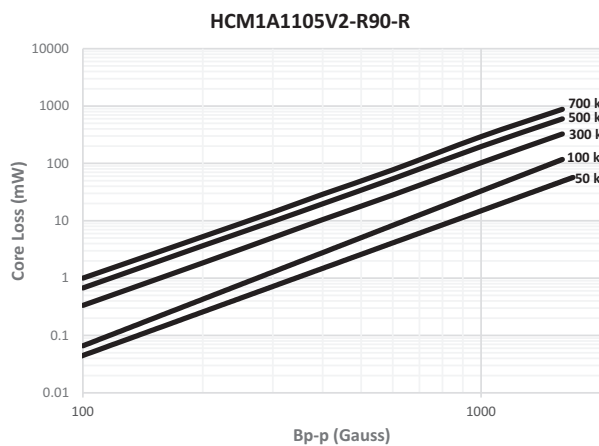
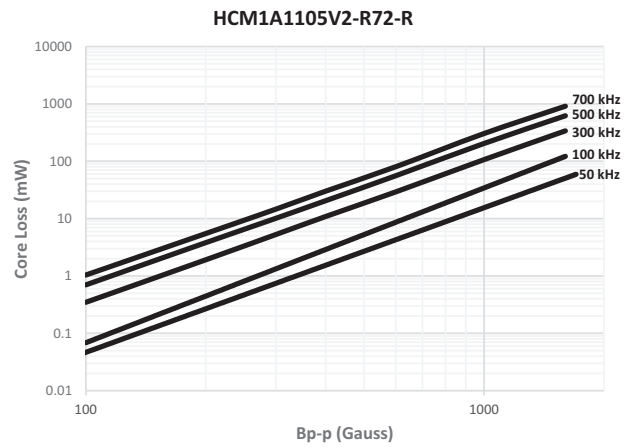
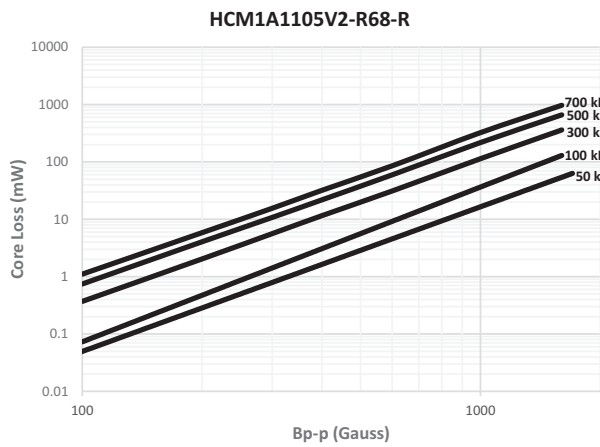

Core loss vs B_{p-p}

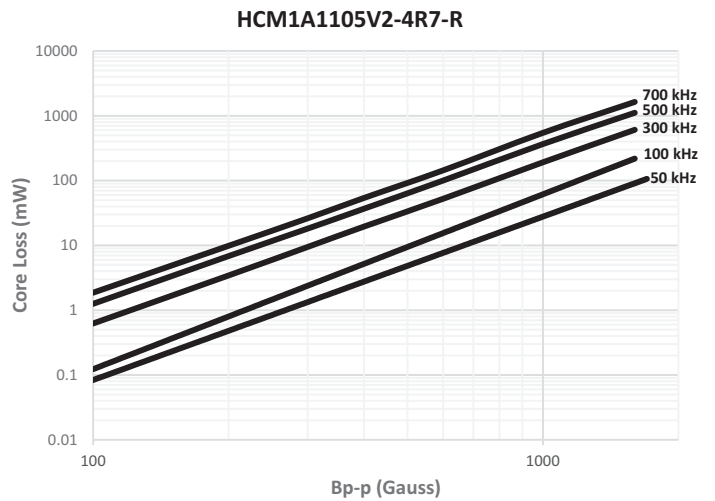
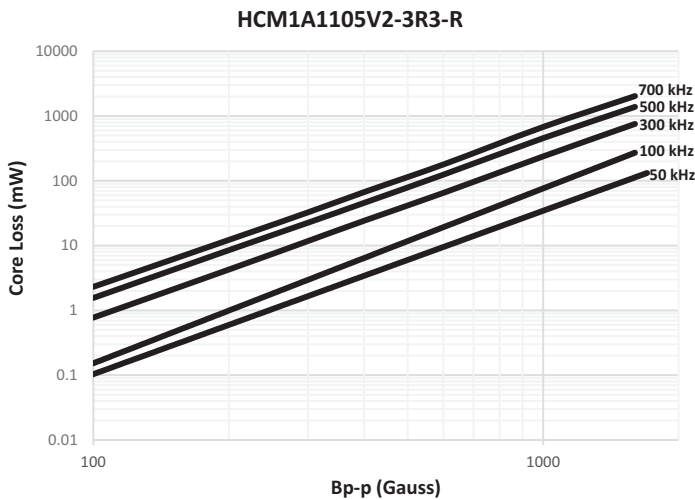
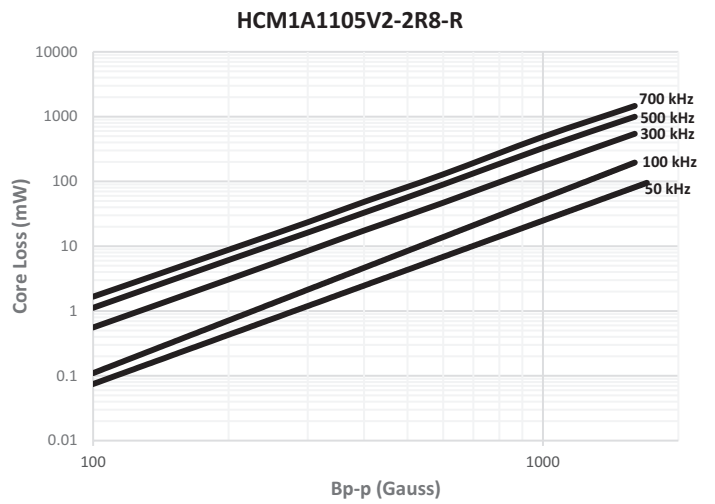
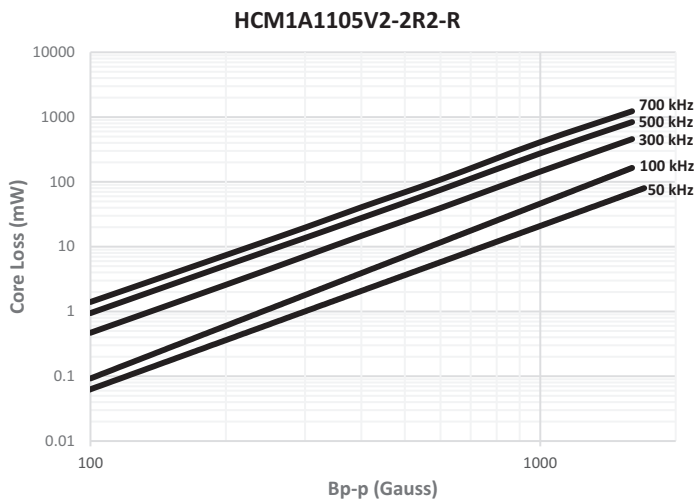
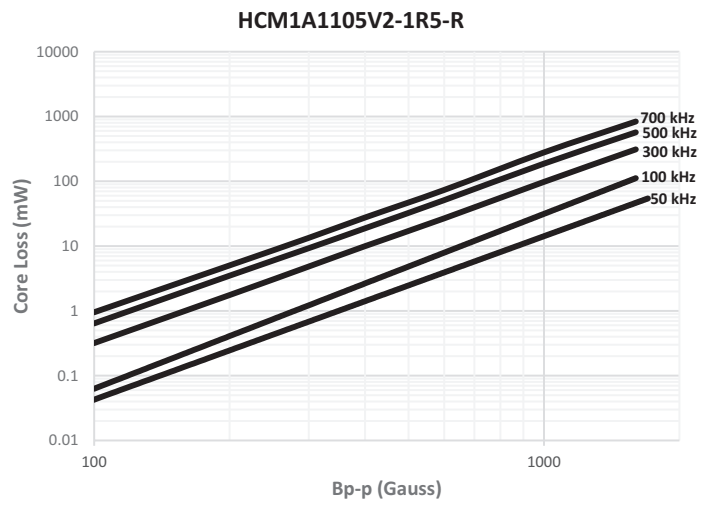
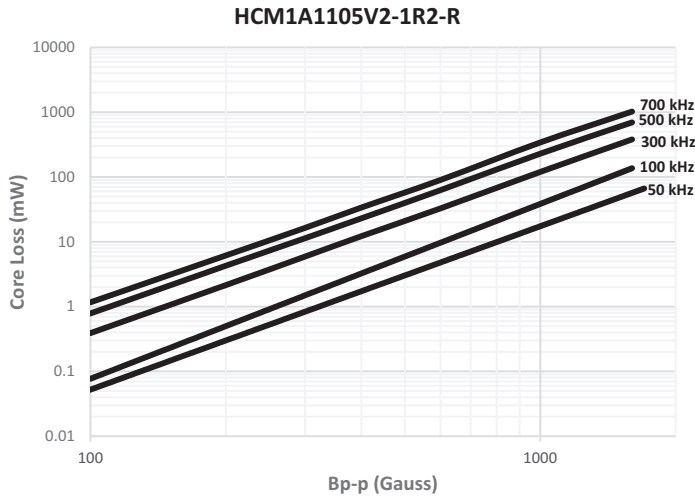

Core loss vs B_{p-p}

HCM1A1105V2-5R6-R

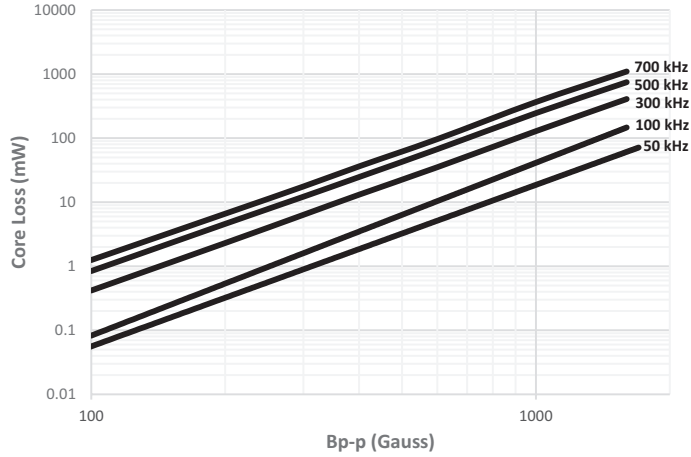

HCM1A1105V2-6R8-R

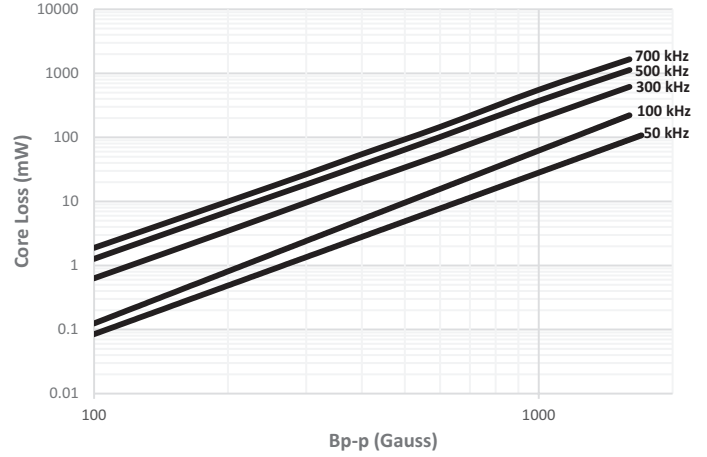

HCM1A1105V2-100-R

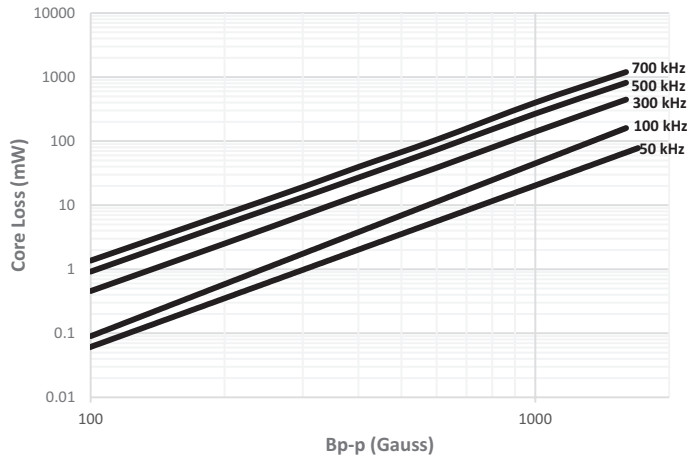

HCM1A1105V2-120-R

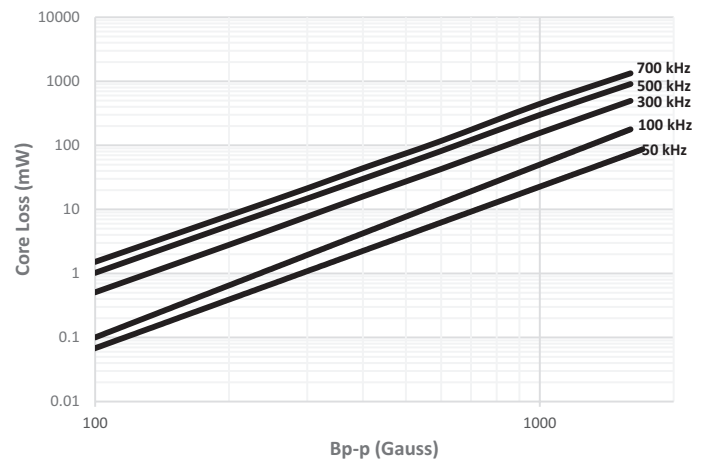

HCM1A1105V2-150-R

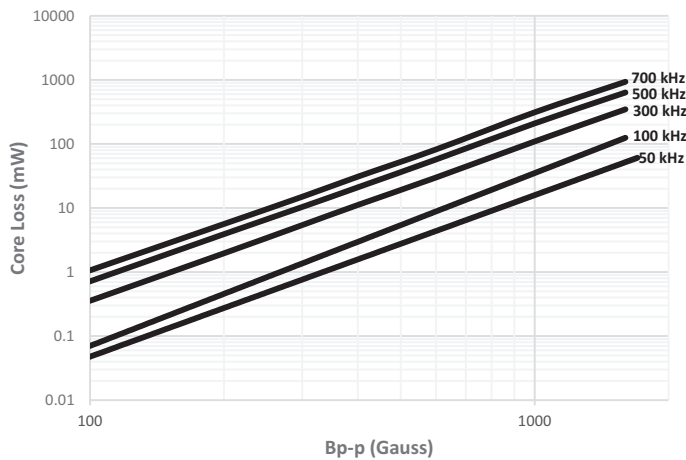

HCM1A1105V2-220-R

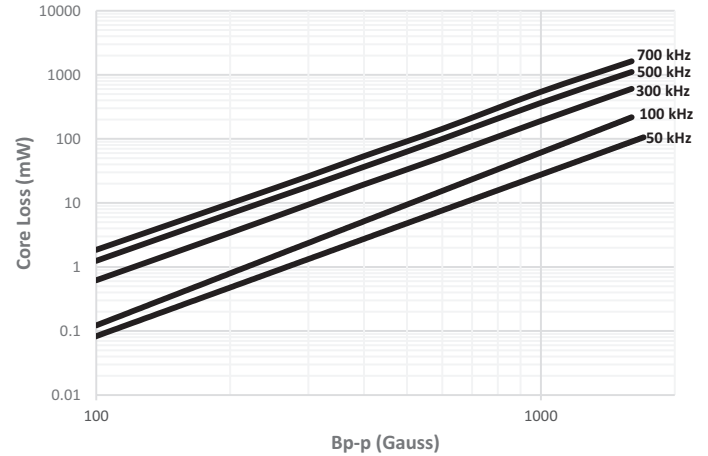

Core loss vs B_{p-p}

HCM1A1105V2-330-R

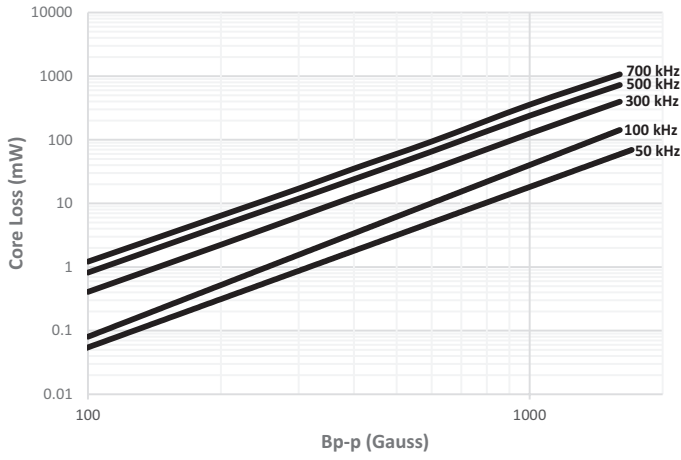

HCM1A1105V2-470-R

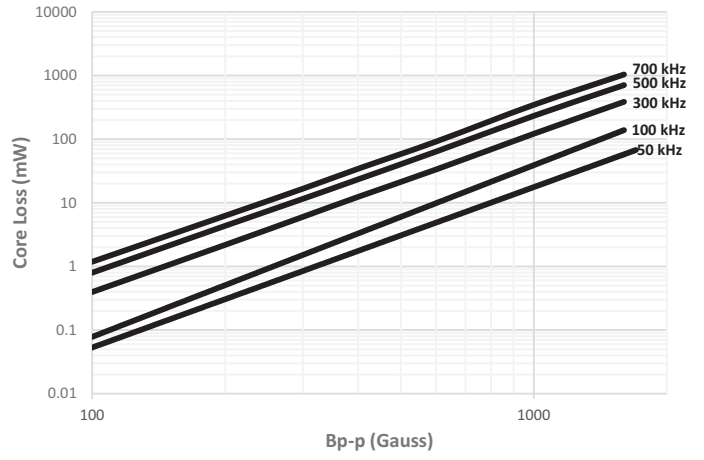

HCM1A1105V2-680-R

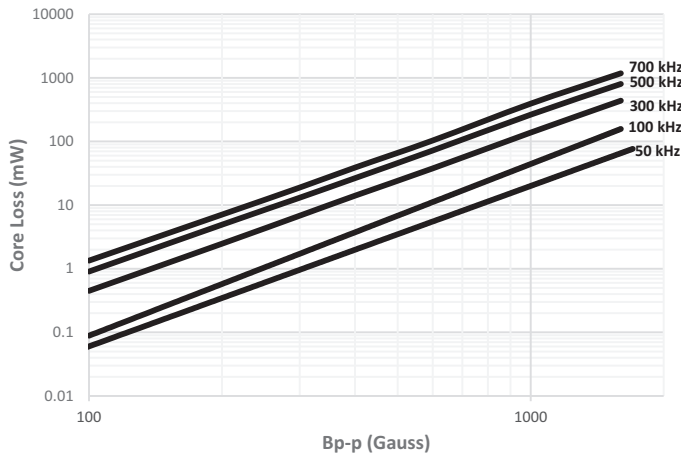

Inductance and impedance vs. frequency

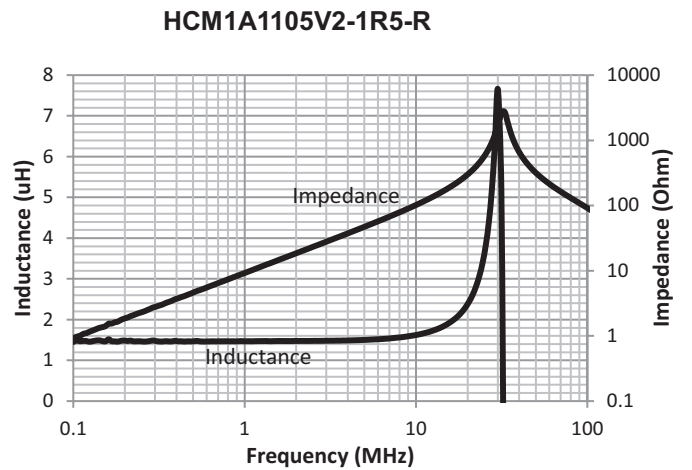
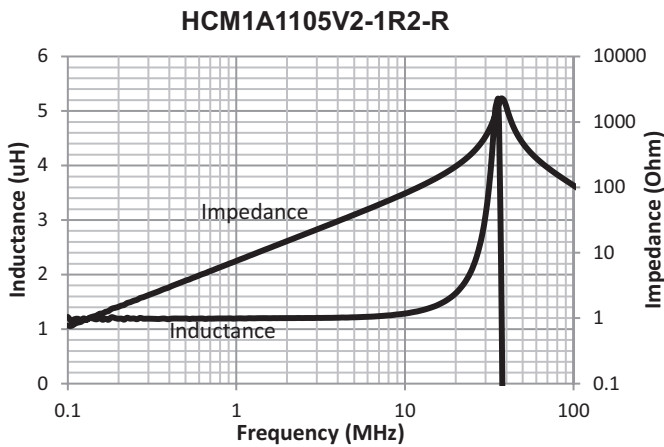
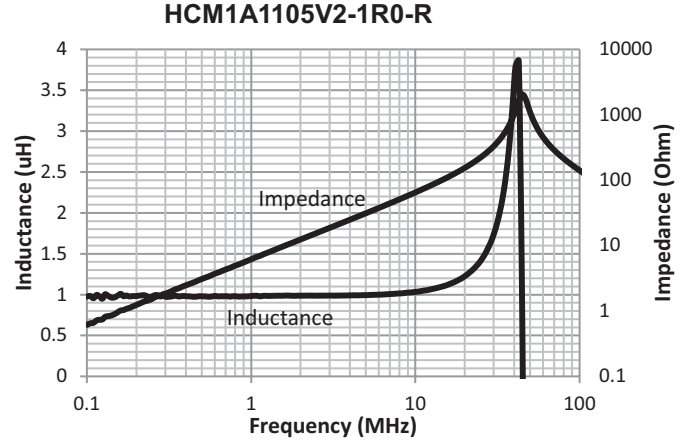
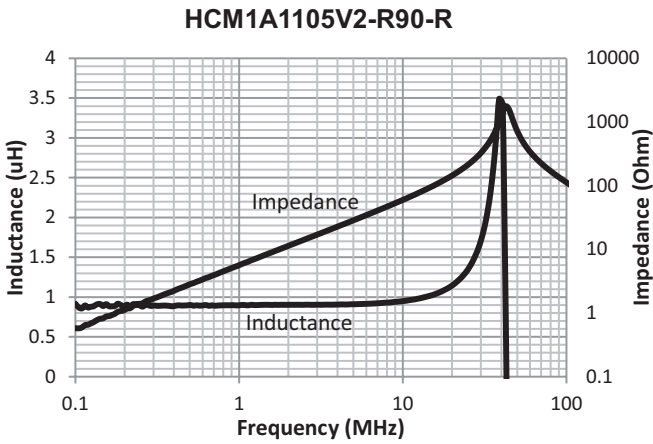
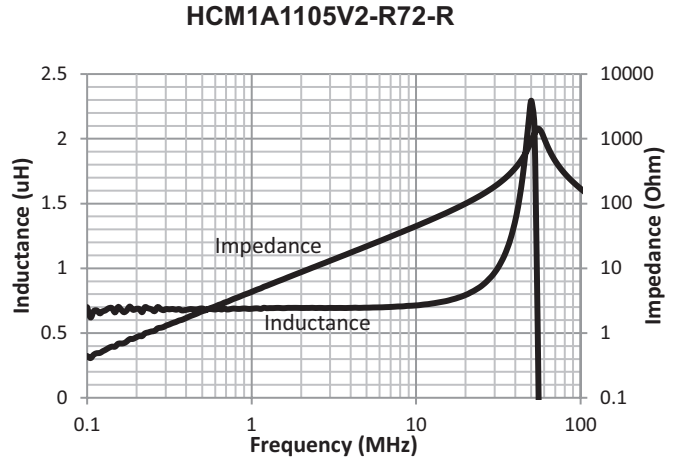
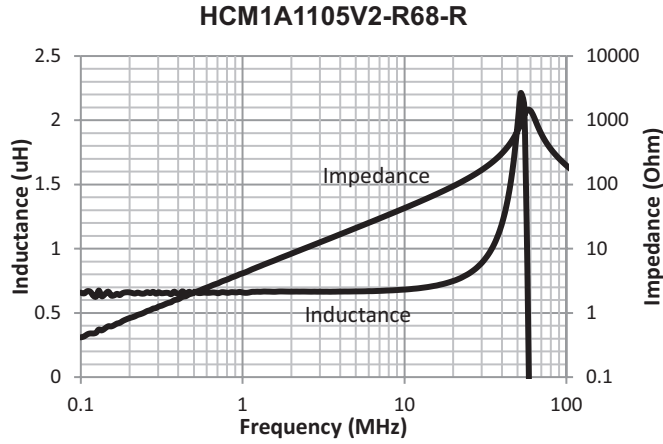

Inductance and impedance vs. frequency

HCM1A1105V2-2R2-R

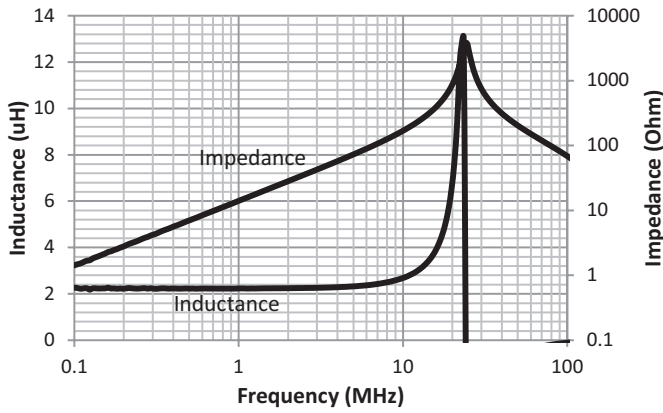

HCM1A1105V2-2R8-R

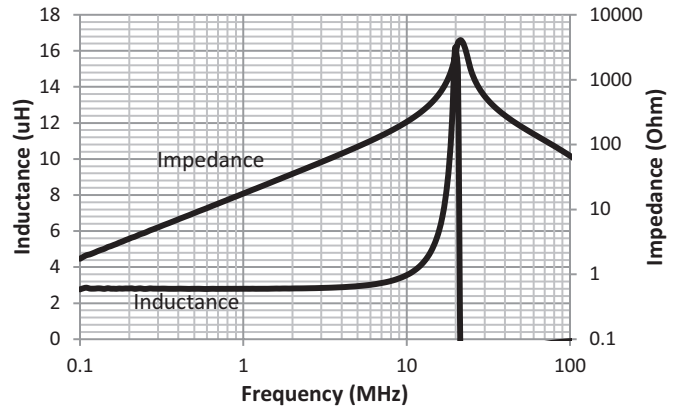

HCM1A1105V2-3R3-R

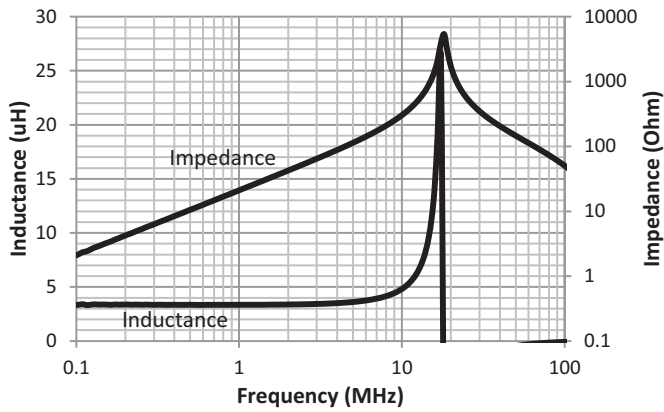

HCM1A1105V2-4R7-R

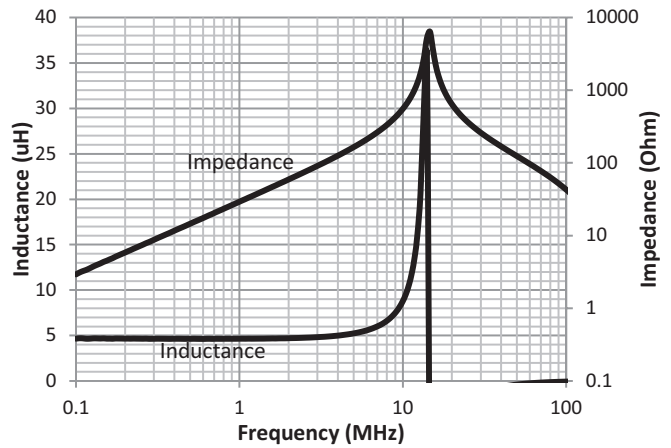

HCM1A1105V2-5R6-R

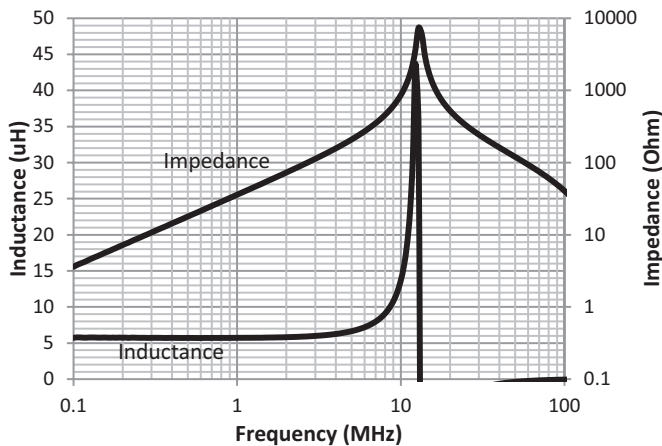

HCM1A1105V2-6R8-R

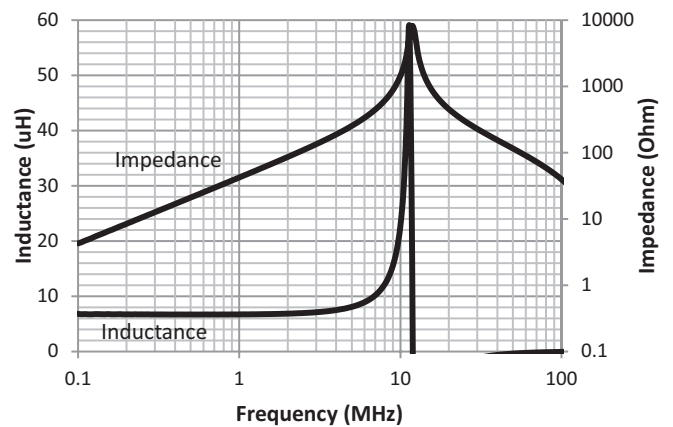

Inductance and impedance vs. frequency

HCM1A1105V2-100-R

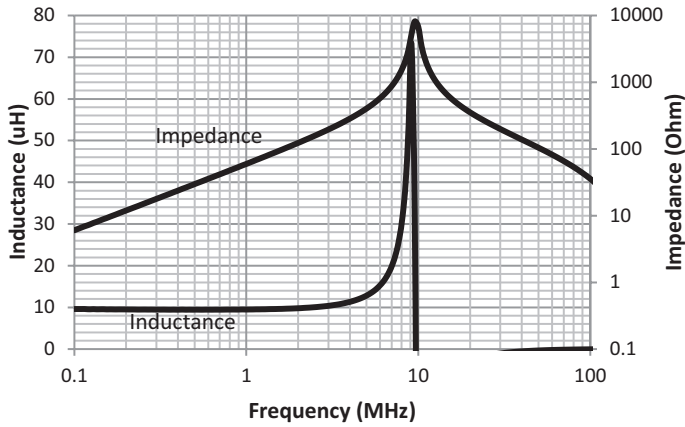

HCM1A1105V2-120-R

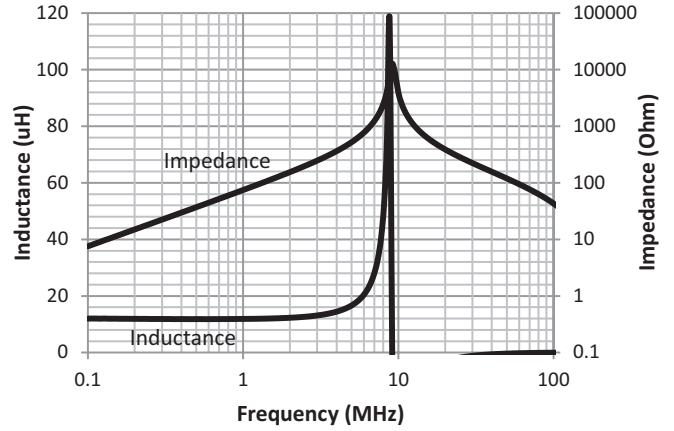

HCM1A1105V2-150-R

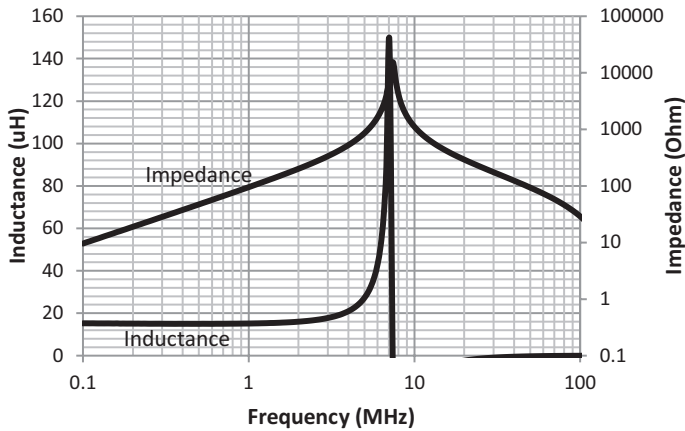

HCM1A1105V2-220-R

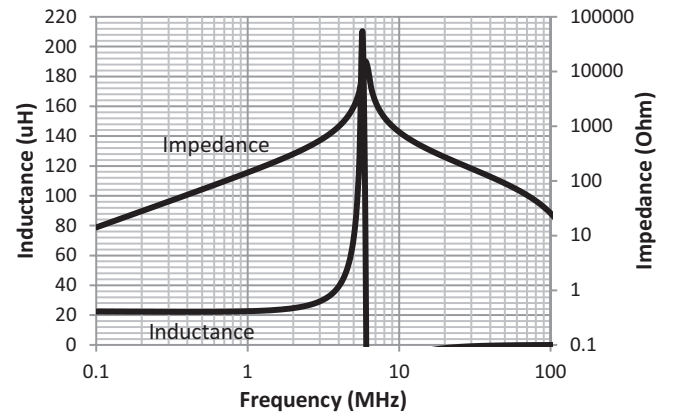

HCM1A1105V2-330-R

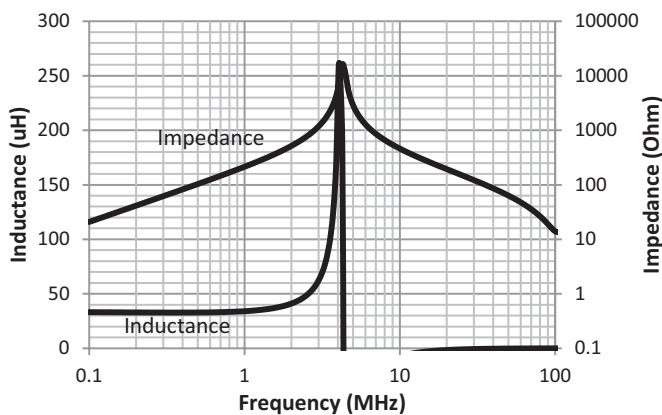

HCM1A1105V2-470-R

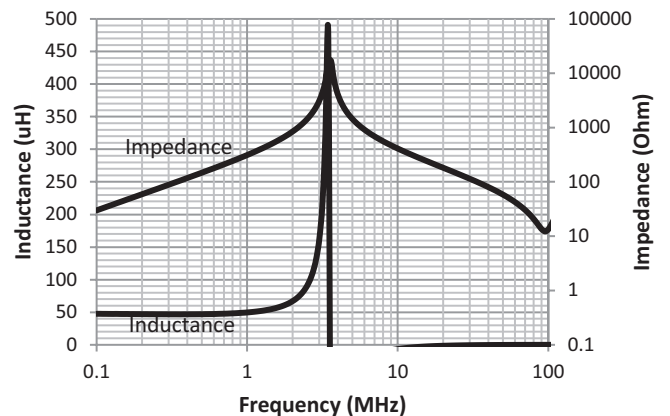

Inductance and impedance vs. frequency

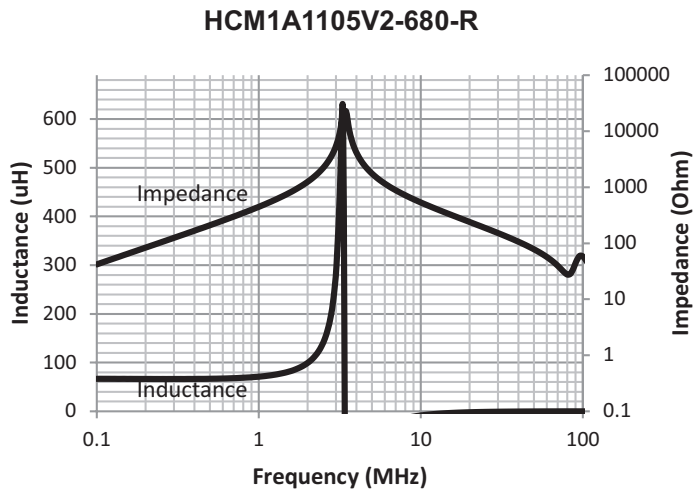

Inductance and temperature rise vs. current

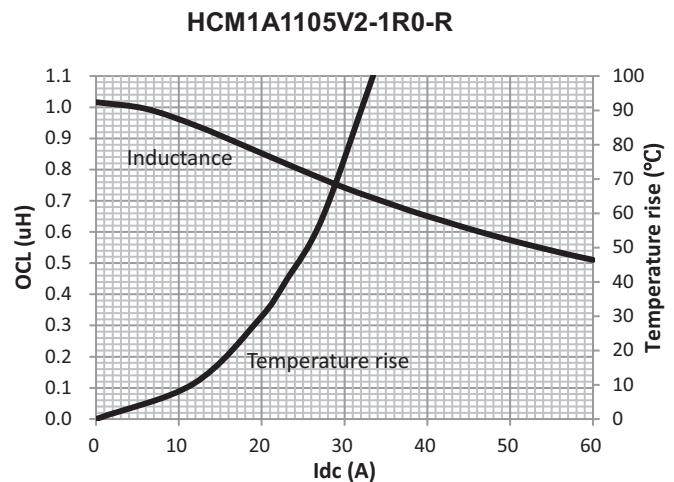
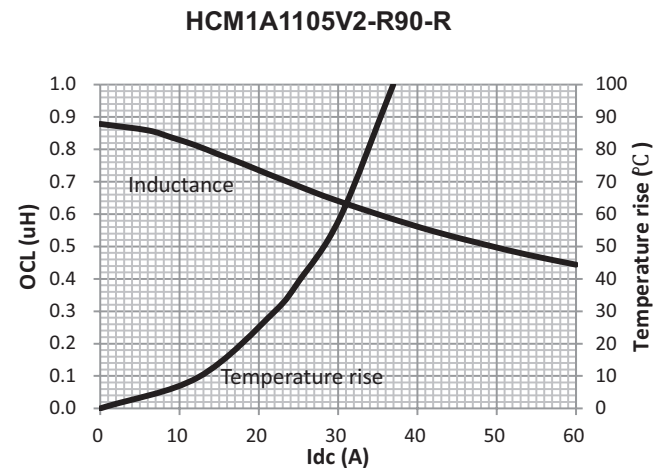
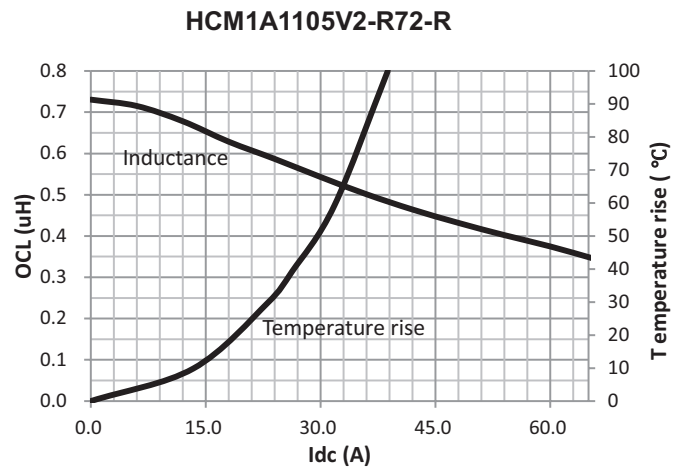
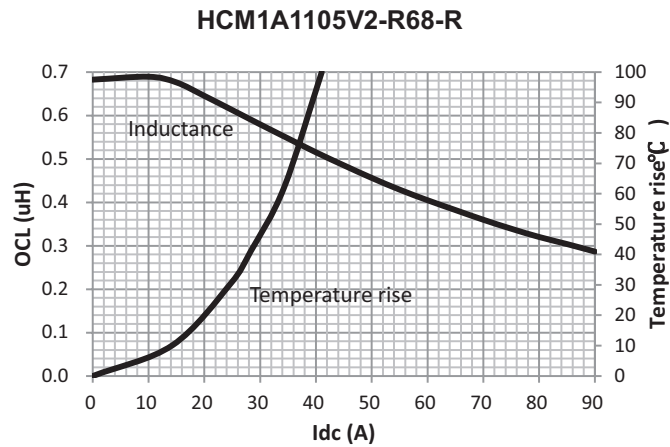

Inductance and temperature rise vs. current

HCM1A1105V2-1R2-R

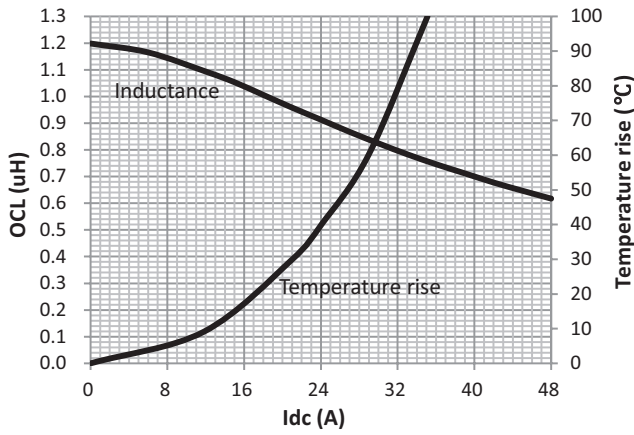

HCM1A1105V2-1R5-R

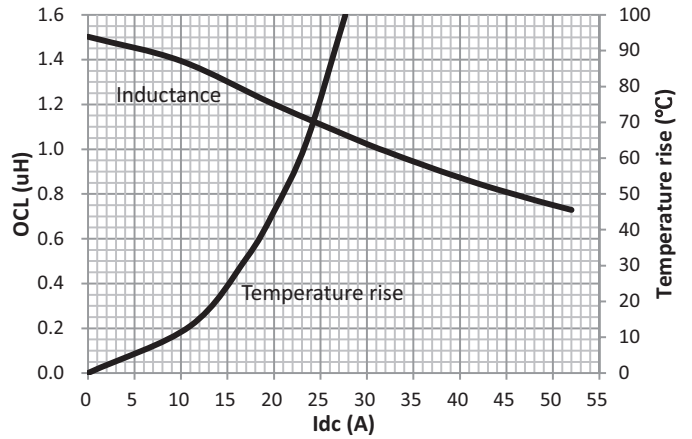

HCM1A1105V2-2R2-R

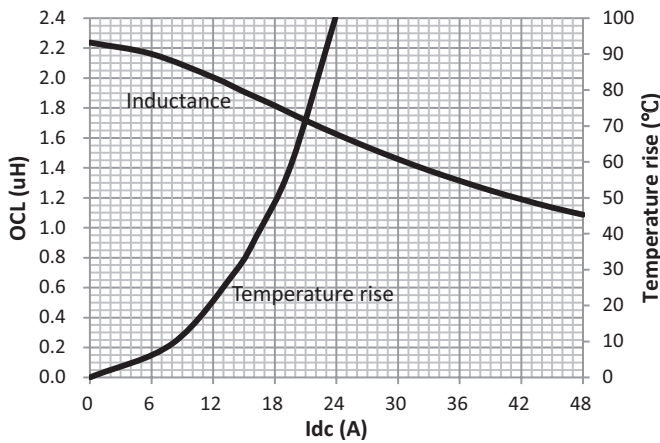

HCM1A1105V2-2R8-R

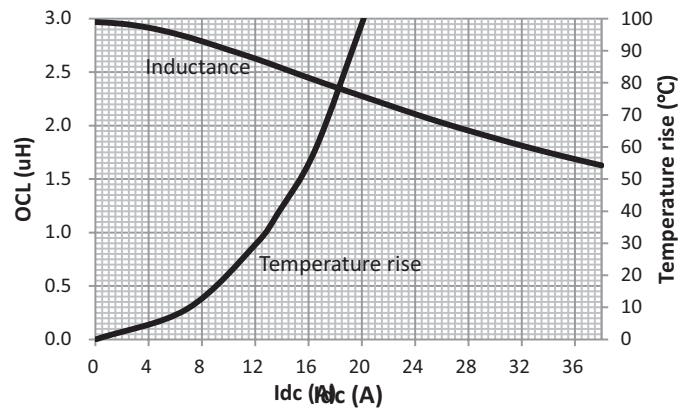

HCM1A1105V2-3R3-R

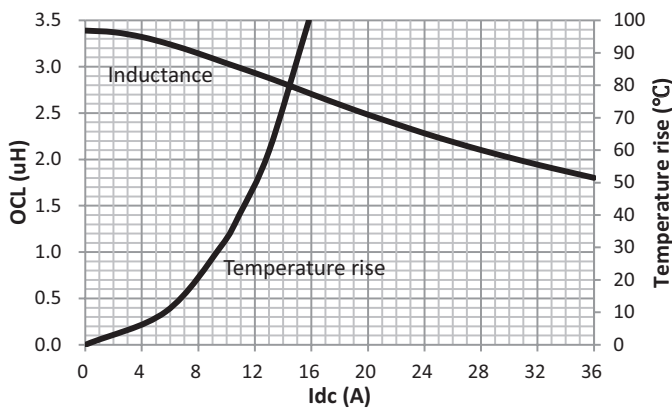

HCM1A1105V2-4R7-R

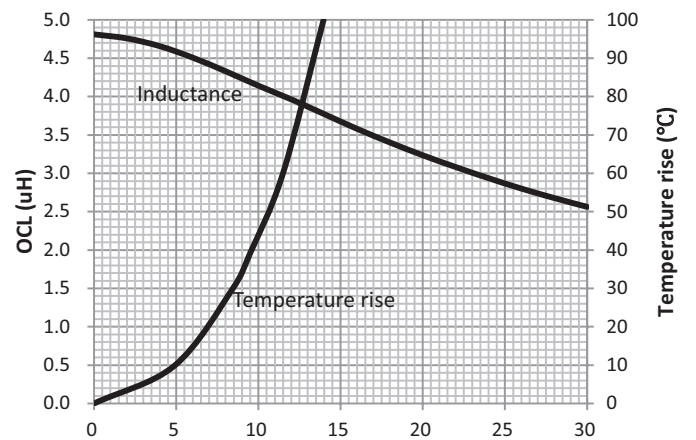

Inductance and temperature rise vs. current

HCM1A1105V2-5R6-R

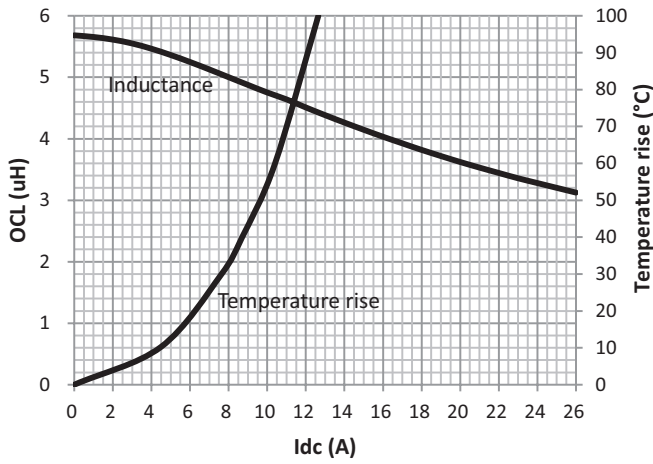

HCM1A1105V2-6R8-R

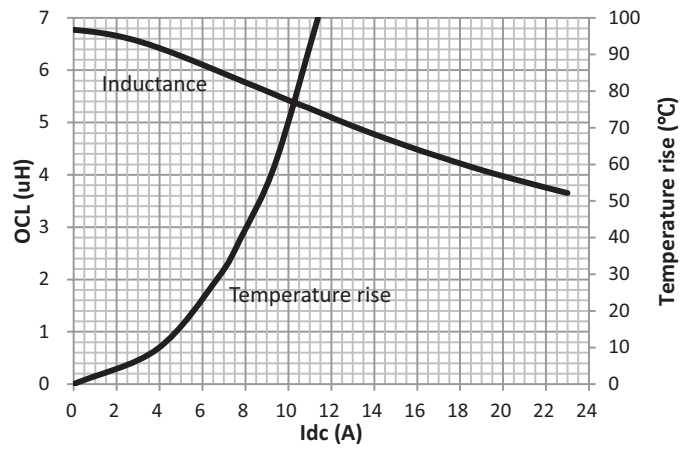

HCM1A1105V2-100-R

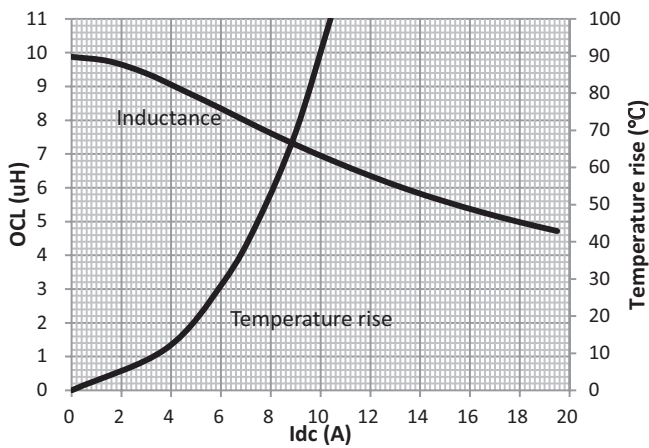

HCM1A1105V2-120-R

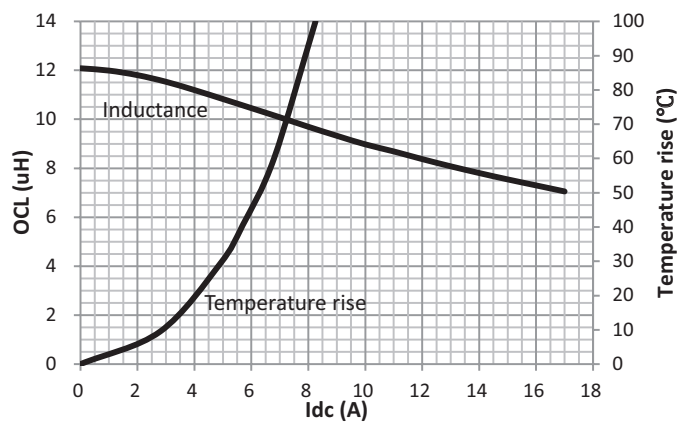

HCM1A1105V2-150-R

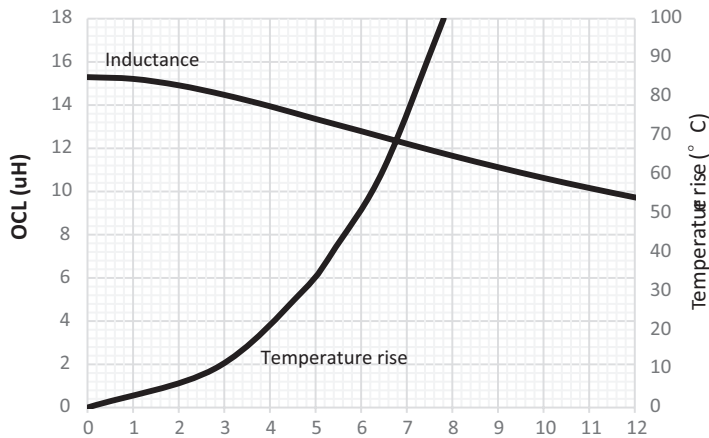

HCM1A1105V2-220-R

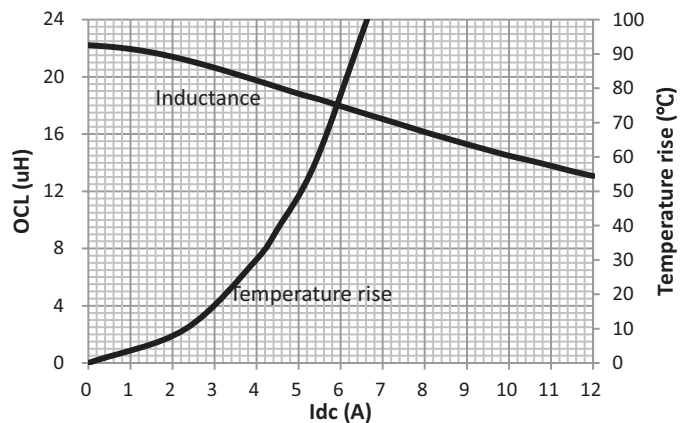

Inductance and temperature rise vs. current

HCM1A1105V2-330-R

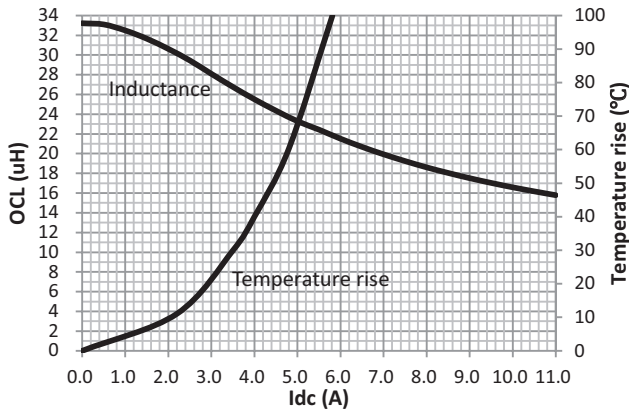

HCM1A1105V2-470-R

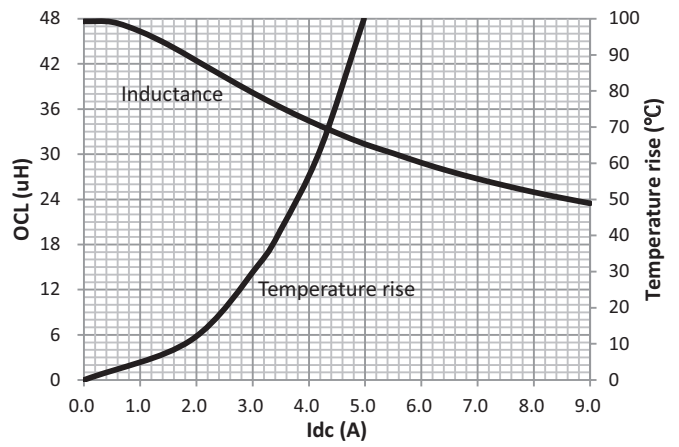

HCM1A1105V2-680-R

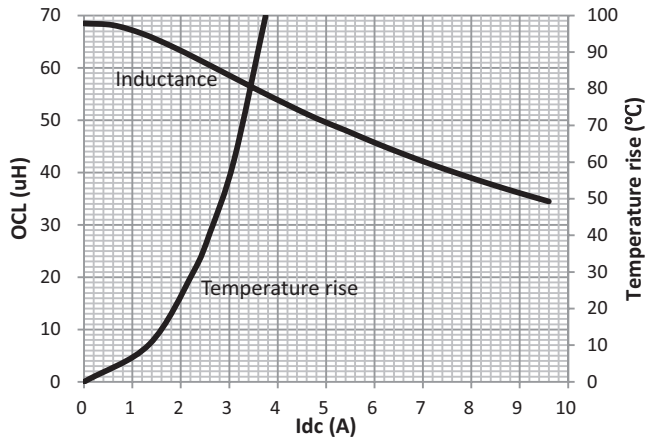

Solder reflow profile

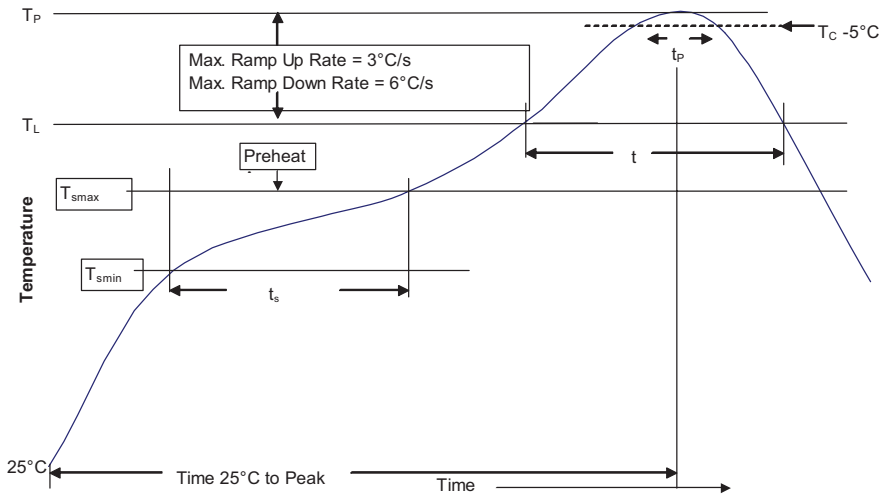

Table 1 - Standard SnPb solder (T_c)

| Package thickness | Volume mm ³ <350 | Volume mm ³ ≥350 |
|-------------------|-----------------------------|-----------------------------|
| <2.5 mm | 235 °C | 220 °C |
| ≥2.5 mm | 220 °C | 220 °C |

Table 2 - Lead (Pb) free solder (T_c)

| Package thickness | Volume mm ³ <350 | Volume mm ³ 350 - 2000 | Volume mm ³ >2000 |
|-------------------|-----------------------------|-----------------------------------|------------------------------|
| <1.6 mm | 260 °C | 260 °C | 260 °C |
| 1.6 – 2.5 mm | 260 °C | 250 °C | 245 °C |
| >2.5 mm | 250 °C | 245 °C | 245 °C |

Reference J-STD-020

| Profile feature | Standard SnPb solder | Lead (Pb) free solder |
|--|----------------------|-----------------------|
| Preheat and Soak | | |
| • Temperature min. (T _{smin}) | 100 °C | 150 °C |
| • Temperature max. (T _{smax}) | 150 °C | 200 °C |
| • Time (T _{smin} to T _{smax}) (t _s) | 60-120 seconds | 60-120 seconds |
| Average ramp up rate T _{smax} to T _p | 3 °C/ second max. | 3 °C/ second max. |
| Liquidous temperature (T _L) | 183 °C | 217 °C |
| Time at liquidous (t _L) | 60-150 seconds | 60-150 seconds |
| Peak package body temperature (T _p)* | Table 1 | Table 2 |
| Time (t _p)** within 5 °C of the specified classification temperature (T _c) | 20 seconds** | 30 seconds** |
| Average ramp-down rate (T _p to T _{smax}) | 6 °C/ second max. | 6 °C/ second max. |
| Time 25 °C to peak temperature | 6 minutes max. | 8 minutes max. |

* Tolerance for peak profile temperature (T_p) is defined as a supplier minimum and a user maximum.
** Tolerance for time at peak profile temperature (t_p) is defined as a supplier minimum and a user maximum.

Life Support Policy: Eaton does not authorize the use of any of its products for use in life support devices or systems without the express written approval of an officer of the Company. Life support systems are devices which support or sustain life, and whose failure to perform, when properly used in accordance with instructions for use provided in the labeling, can be reasonably expected to result in significant injury to the user.

Eaton reserves the right, without notice, to change design or construction of any products and to discontinue or limit distribution of any products. Eaton also reserves the right to change or update, without notice, any technical information contained in this bulletin.

Eaton
Electronics Division
1000 Eaton Boulevard
Cleveland, OH 44122
United States
www.eaton.com/electronics

© 2019 Eaton
All Rights Reserved
Printed in USA
Publication No. 10909 BU-MC19045
April 2019

Eaton is a registered trademark.
All other trademarks are property of their respective owners.

Follow us on social media to get the latest product and support information.



Mouser Electronics

Authorized Distributor

Click to View Pricing, Inventory, Delivery & Lifecycle Information:

Eaton:

[HCM1A1105V2-100-R](#) [HCM1A1105V2-120-R](#) [HCM1A1105V2-150-R](#) [HCM1A1105V2-1R0-R](#) [HCM1A1105V2-1R2-R](#)
[HCM1A1105V2-1R5-R](#) [HCM1A1105V2-R72-R](#) [HCM1A1105V2-R90-R](#) [HCM1A1105V2-4R7-R](#) [HCM1A1105V2-5R6-](#)
[R HCM1A1105V2-680-R](#) [HCM1A1105V2-6R8-R](#) [HCM1A1105V2-R47-R](#) [HCM1A1105V2-R68-R](#) [HCM1A1105V2-220-](#)
[R HCM1A1105V2-2R2-R](#) [HCM1A1105V2-2R8-R](#) [HCM1A1105V2-330-R](#) [HCM1A1105V2-3R3-R](#) [HCM1A1105V2-470-](#)
[R](#)