

STSP84XXXXXX

TVS Diode array ESD suppressor

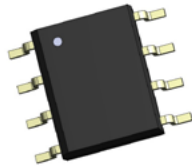

Product features

- Protects four I/O lines
- Low clamping voltage
- Low operating voltage
- Meets moisture sensitivity level (MSL) 3
- Molding compound flammability rating: UL 94V-0
- Termination finish: Tin

Applications

- WAN/LAN equipment
- Desktops, servers, notebooks & handhelds
- Switching systems
- Audio/video inputs
- 10/100/1000 ethernet
- Base stations

Environmental compliance and general specifications

- IEC61000-4-2 (ESD)
 - Up to ± 30 kV (air)
 - Up to ± 30 kV (contact)
- IEC61000-4-5 (Lightning) Up to 50 A (8/20 μ s)



Pin out/functional diagram



STSP84150B601

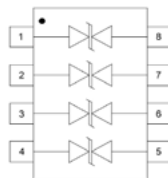

Pin Configuration (Top view)

Ordering part number

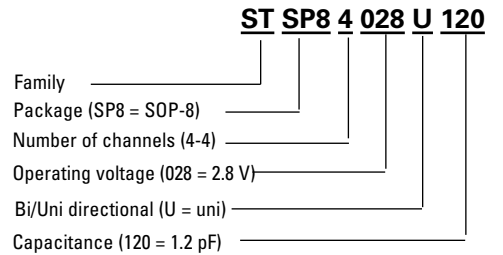

STSP84028U120
STSP84028UL65

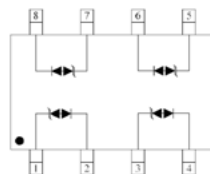

PIN Configuration

STSP84033U800
STSP84050U800

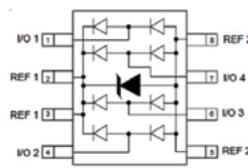

Pin configuration

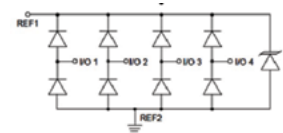

Circuit diagram

Absolute maximum ratings

(+25 °C, RH=45%-75%, unless otherwise noted)

Parameter	Symbol	Value					Unit
		STSP84028 U120	STSP84028 UL65	STSP84033 U800	STSP84050 U800	STSP84150 B601	
Peak pulse power dissipation on 8/20 μs waveform	P_{pp}	1000	600	500	500	300	W
ESD per IEC 61000-4-2 (Air)	V_{ESD}	+/-30	+/-30	+/-15	+/-15	+/-15	kV
ESD per IEC 61000-4-2 (Contact)		+/-30	+/-30	+/-8	+/-8	+/-8	
Lead soldering temperature	T_L	+260 (10 seconds)					°C
Operating junction temperature range	T_J	-55 to +125					°C
Storage temperature range	T_{STG}	-55 to +150					°C

Electrical characteristics

(+25 °C)

STSP84028U120

Parameter	Test condition	Minimum	Typical	Maximum	Symbol (Units)
Reverse working voltage	-	-	-	2.8	V_{RWM} (V)
Holding voltage	$I_h = 10$ mA	3.0	-	-	V_h
Reverse leakage current	$V_{RWM} = 2.8$ V	-	-	1	I_R (μA)
Clamping voltage	$I_{pp} = 2$ A, $t_p = 8/20$ μs	-	-	5.5	V_c (V)
	$I_{pp} = 10$ A, $t_p = 8/20$ μs	-	-	10	V_c (V)
	$I_{pp} = 50$ A, $t_p = 8/20$ μs	-	-	18	V_c (V)
Junction capacitance	$V_{RWM} = 0$ V, $f = 1$ MHz	-	1.2	2.0	C_J (pF)

STSP84028UL65

Parameter	Test condition	Minimum	Typical	Maximum	Symbol (Units)
Reverse working voltage	-	-	-	2.8	V_{RWM} (V)
Reverse breakdown voltage	$I_I = 1$ mA	3.0	-	-	V_{BR} (V)
Reverse leakage current	$V_{RWM} = 2.8$ V	-	0.01	0.1	I_R (μA)
Clamping voltage	$I_{pp} = 2$ A, $t_p = 8/20$ μs	-	-	7.6	V_c (V)
	$I_{pp} = 20$ A, $t_p = 8/20$ μs	-	14	20	V_c (V)
Junction capacitance	$V_{RWM} = 0$ V, $f = 1$ MHz	-	0.65	1	C_J (pF)

STSP84033U800

Parameter	Test condition	Minimum	Typical	Maximum	Symbol (Units)
Reverse working voltage	-	-	-	3.3	V_{RWM} (V)
Reverse leakage current	$V_{RWM} = 3.3$ V	-	-	1	I_R (μ A)
Punch-through voltage	$I_{PT} = 2$ μ A	3.5	-	-	V_{PT} (V)
Snapback voltage	$I_{SB} = 50$ mA	2.8	-	-	V_{SB} (V)
Clamping voltage	$I_{pp} = 1$ A, $t_p = 8/20$ μ s	-	-	5.3	V_C (V)
	$I_{pp} = 10$ A, $t_p = 8/20$ μ s	-	-	10	V_C (V)
	$I_{pp} = 25$ A, $t_p = 8/20$ μ s	-	-	15	V_C (V)
Junction capacitance	$V_{RWM} = 0$ V, $f = 1$ MHz	-	8	15	C_J (pF)
	$V_{RWM} = 0$ V, $f = 1$ MHz; Between I/O pins and GND	-	4	-	C_J (pF)

STSP84050U800

Parameter	Test condition	Minimum	Typical	Maximum	Symbol (Units)
Reverse working voltage	-	-	-	5	V_{RWM} (V)
Reverse breakdown voltage	$I_T = 1$ mA	6	-	-	V_{BR} (V)
Reverse leakage current	$V_{RWM} = 5$ V	-	-	10	I_R (μ A)
Clamping voltage	$I_{pp} = 1$ A, $t_p = 8/20$ μ s	-	-	9.8	V_C (V)
	$I_{pp} = 10$ A, $t_p = 8/20$ μ s	-	-	12	V_C (V)
	$I_{pp} = 25$ A, $t_p = 8/20$ μ s	-	-	20	V_C (V)
Junction capacitance	$V_{RWM} = 0$ V, $f = 1$ MHz	-	8	15	C_J (pF)
	$V_{RWM} = 0$ V, $f = 1$ MHz; Between I/O pins and GND	-	4	-	C_J (pF)

STSP84150B601

Parameter	Test condition	Minimum	Typical	Maximum	Symbol (Units)
Reverse working voltage	-	-	-	15	V_{RWM} (V)
Reverse breakdown voltage	$I_T = 1$ mA	16.5	-	-	V_{BR} (V)
Reverse leakage current	$V_{RWM} = 15$ V	-	-	1	I_R (μ A)
Peak pulse current	$t_p = 8/20$ μ s	-	-	12	I_{pp} (A)
Clamping voltage	$I_{pp} = 1$ A, $t_p = 8/20$ μ s	-	-	24	V_C (V)
	$I_{pp} = 12$ A, $t_p = 8/20$ μ s	-	-	30	V_C (V)
Junction capacitance	$V_{RWM} = 0$ V, $f = 1$ MHz	-	-	60	C_J (pF)

Mechanical parameters, pad layout- mm/inches

STSP84033U800, STSP84050U800& STSP84150B601

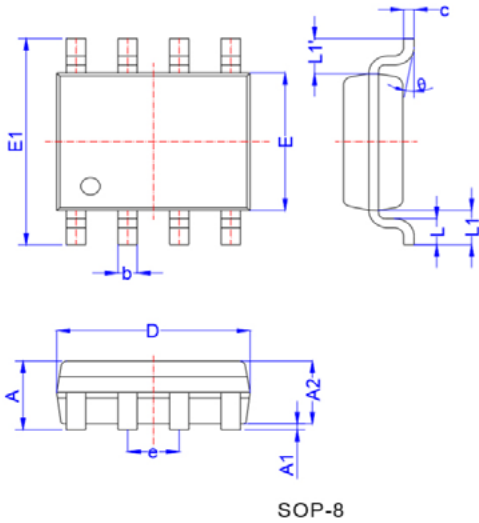

Dimension	Millimeters			Inches		
	Min.	Typ.	Max.	Min.	Typ.	Max.
A	1.40		1.70	0.055		0.067
A1	0.05		0.15	0.002		0.006
A2	1.35		1.55	0.053		0.061
b	0.31		0.51	0.012		0.020
c	0.17		0.25	0.007		0.010
D	4.70		5.10	0.185		0.201
E	3.80		4.00	0.150		0.157
E1	5.80		6.20	0.228		0.244
e	1.14	1.27	1.40	0.045	0.050	0.055
L	0.62		0.77	0.024		0.030
L1	1.00	1.02	1.04	0.039	0.040	0.041
L1-L1'			0.12			0.005
θ	0°		8°	0°		8°

STSP84028U120&STSP84028UL65

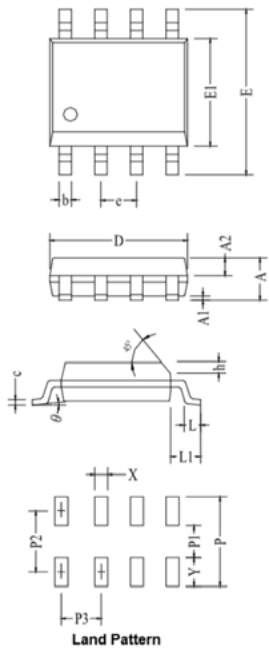

Dimension	Millimeters		Inches	
	Min.	Max.	Min.	Max.
A	1.35	1.75	0.053	0.069
A1	0.10	0.25	0.004	0.010
A2	0.67	0.77	0.026	0.030
b	0.33	0.51	0.013	0.020
c	0.17	0.25	0.007	0.010
D	4.70	5.10	0.185	0.201
e	1.27 BSC		0.05 BSC	
E	5.80	6.20	0.228	0.244
E1	3.80	4.00	0.150	0.157
h	0.25	0.50	0.010	0.020
θ	0°	8°	0°	8°
L	0.40	1.27	0.016	0.050
L1	1.04 BSC		0.041 BSC	
X	0.60		0.24	
Y	2.20		0.037	
P	7.40		0.291	
P1	3.00		0.118	
P2	5.20		0.205	
P3	1.27		0.050	

Part marking

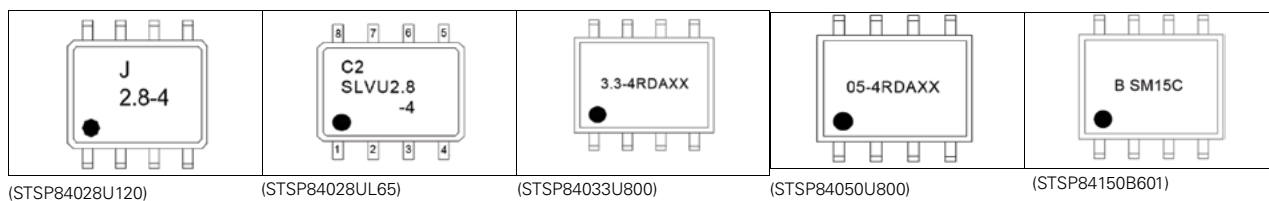

Packaging information mm/inches

Drawing not to scale.

Supplied in tape and reel packaging, 2,500 parts per 7" diameter reel (EIA-481 compliant)

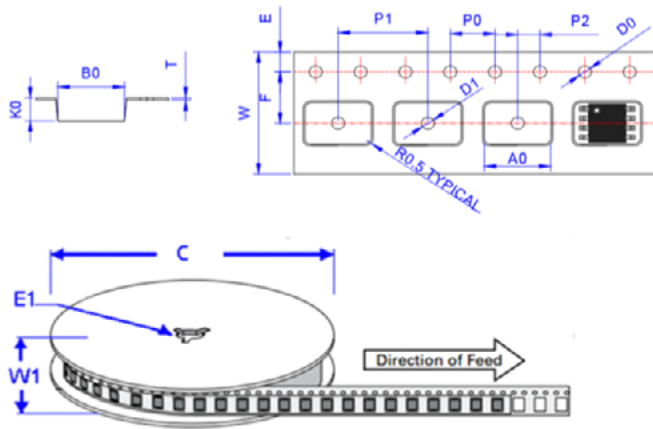

Ref.	Dimensions	
	Millimeters	Inches
A0	6.6±0.10	0.260 ± 0.004
B0	5.3±0.10	0.209 ± 0.004
C	330	13.0
D0	1.50±0.10	0.059 + 0.004
D1	1.50±0.10	0.059 + 0.004
E1	13.3±0.3	0.524± 0.012
E	1.75±0.1	0.069± 0.004
F	5.5±0.05	0.217 ± 0.002
K0	2.1±0.1	0.083 ± 0.004
P0	4.0±0.1	0.157± 0.004
P1	8.0±0.1	0.315± 0.004
P2	2.0±0.05	0.079 ± 0.002
T	0.24±0.1	0.009 ± 0.002
W	12.0±0.3	0.472 ± 0.012
W1	15.7±2.0	0.618 ± 0.079

Ratings and V-I characteristic curves (+25 °C unless otherwise noted)

V- I curve characteristics (Uni-directional)

STSP84028U120, STSP84028UL65, STSP84033U800

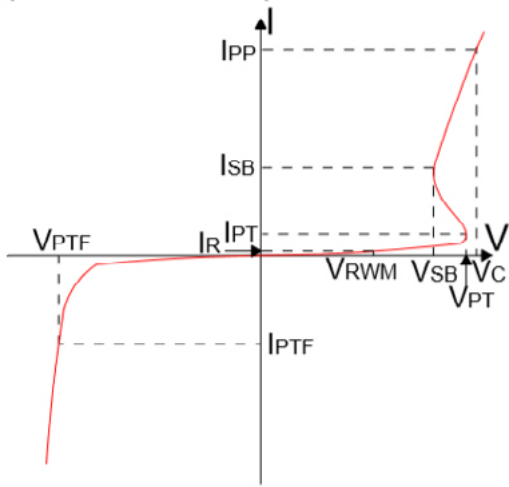

V- I curve characteristics (Uni-directional)

STSP84050U800

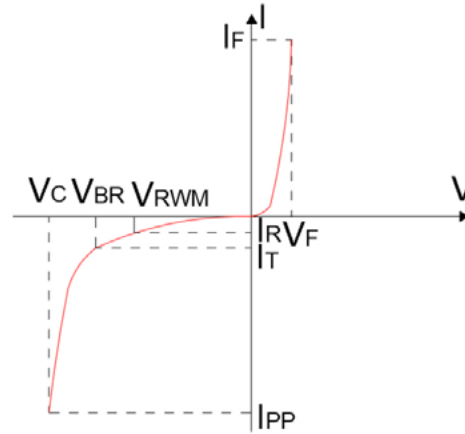

V- I curve characteristics (Bi-directional)

STSP84150B601

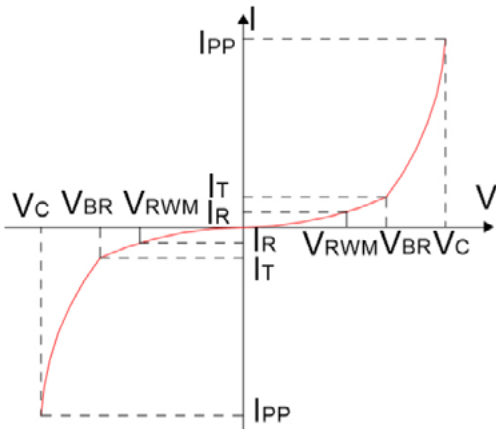

Pulse waveform (8/20 μs)

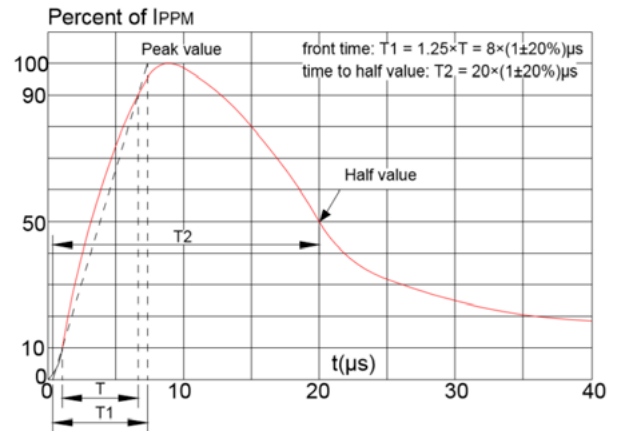

Pulse derating curve

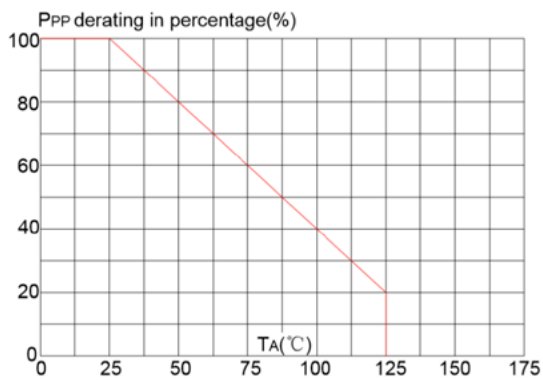

ESD waveform

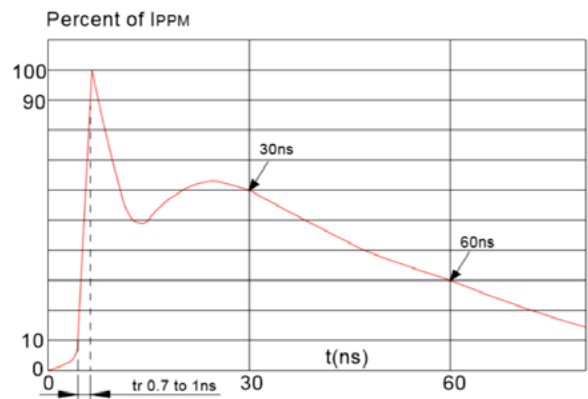

Application information

STSP84028U120 can be configured in different connections to meet the requirement of common-mode and differential-mode as shown in the diagrams below.

Four line uni-directional common-mode protection

- Pin 1 is connected to Line 1
- Pin 3 is connected to Line 2
- Pin 5 is connected to Line 3
- Pin 7 is connected to Line 4
- Pin 2, 4, 6 and 8 are connected to ground

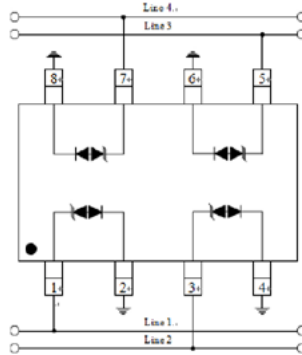

Two Line bi-directional common-mode protection

- Pin 1 & 4 is connected to Line 1
- Pin 5 & 8 is connected to Line 2
- Pin 2, 3, 6 and 7 are connected to ground

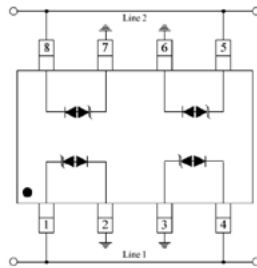

Two line pairs bi-directional differential-mode protection

- Pin 1, 2, 7 and 8 are connected to Line 1
- Pair 1 Pin 3, 4, 5 and 6 are connected to Line Pair 2

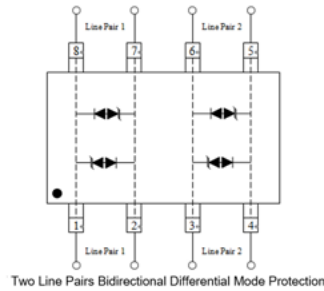

Two Line Pairs Bidirectional Differential Mode Protection

Gigabit ethernet ESD/surge protection

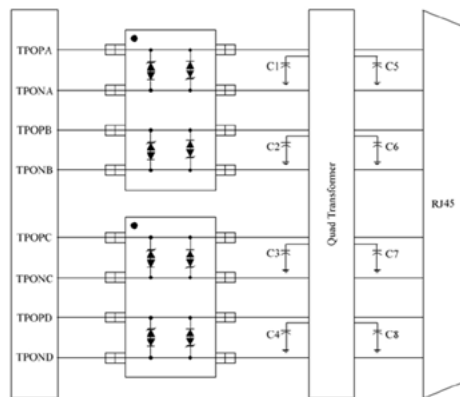

Schematic Diagram for Gigabit Ethernet ESD/ Surge Protection

Solder reflow profile

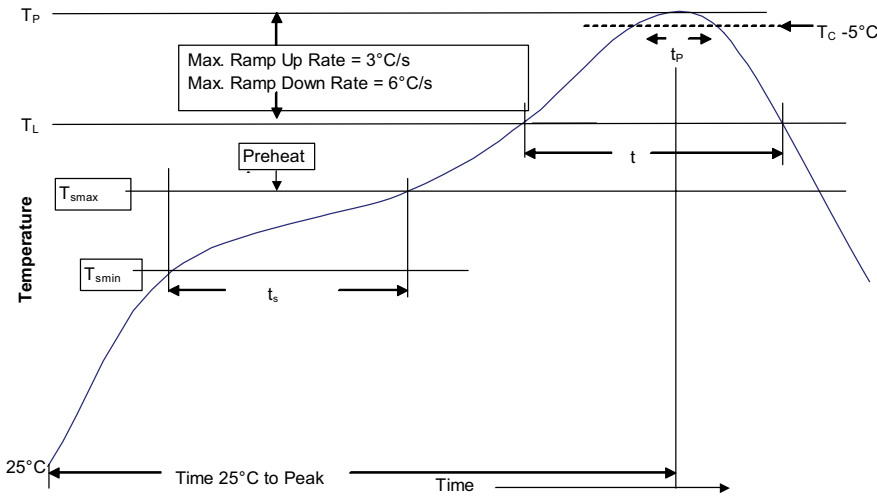

Table 1 - Standard SnPb solder (T_c)

Package thickness	Volume mm ³ <350	Volume mm ³ ≥350
<2.5 mm	235 °C	220 °C
≥2.5 mm	220 °C	220 °C

Table 2 - Lead (Pb) free solder (T_c)

Package thickness	Volume mm ³ <350	Volume mm ³ 350 - 2000	Volume mm ³ >2000
<1.6 mm	260 °C	260 °C	260 °C
1.6 – 2.5 mm	260 °C	250 °C	245 °C
>2.5 mm	250 °C	245 °C	245 °C

Reference J-STD-020

Profile feature	Standard SnPb solder	Lead (Pb) free solder
Preheat and soak	<ul style="list-style-type: none"> Temperature min. (T_{smin}) Temperature max. (T_{smax}) Time (T_{smin} to T_{smax}) (t_s) 	<ul style="list-style-type: none"> 100 °C 150 °C 60-120 seconds
Ramp up rate T_L to T_p	3 °C/ second max.	3 °C/ second max.
Liquidous temperature (T_L) Time (t_L) maintained above T_L	<ul style="list-style-type: none"> 183 °C 60-150 seconds 	<ul style="list-style-type: none"> 217 °C 60-150 seconds
Peak package body temperature (T_p)*	Table 1	Table 2
Time (t_p)* within 5 °C of the specified classification temperature (T_c)	20 seconds*	30 seconds*
Ramp-down rate (T_p to T_L)	6 °C/ second max.	6 °C/ second max.
Time 25 °C to peak temperature	6 minutes max.	8 minutes max.

* Tolerance for peak profile temperature (T_p) is defined as a supplier minimum and a user maximum.

Life Support Policy: Eaton does not authorize the use of any of its products for use in life support devices or systems without the express written approval of an officer of the Company. Life support systems are devices which support or sustain life, and whose failure to perform, when properly used in accordance with instructions for use provided in the labeling, can be reasonably expected to result in significant injury to the user.

Eaton reserves the right, without notice, to change design or construction of any products and to discontinue or limit distribution of any products. Eaton also reserves the right to change or update, without notice, any technical information contained in this bulletin.

Eaton
Electronics Division
1000 Eaton Boulevard
Cleveland, OH 44122
United States
Eaton.com/electronics

© 2020 Eaton
All Rights Reserved
Printed in USA
Publication No. 11160 BU-MC20142
September 2020

Eaton is a registered trademark.
All other trademarks are property of their respective owners.

Follow us on social media to get the latest product and support information.



Mouser Electronics

Authorized Distributor

Click to View Pricing, Inventory, Delivery & Lifecycle Information:

[Eaton:](#)

[STSP84150B601](#) [STSP84028U120](#) [STSP84028UL65](#) [STSP84033U800](#) [STSP84050U800](#)