

FOD8480, FOD8482

Optically Isolated Intelligent Power Module (IPM) Driver in Stretched Body SOP 6-Pin

Description

The FOD8480 and FOD8482 are low power optocouplers, which support isolated interface to Intelligent Power Module (IPM) communicating digital control signals from the controller to the IPM, without conducting ground loops or hazardous voltages.

The FOD848x Series, packaged in a stretched body 6-pin small outline plastic package, consists of an aluminum gallium arsenide (AlGaAs) light emitting diode and an integrated high gain photo detector. The detector has a detector threshold with hysteresis. The hysteresis provides differential mode noise immunity and eliminates the potential for output signal chatter. Its non-inverting output is designed as totem pole, which does not require any pull-up resistor.

The FOD8482 has a lower threshold input current, I_{FLH} , at 3.0 mA maximum. For the complete FOD848x Series, the Electrical and Switching Characteristics are guaranteed over the extended industrial temperature range of -40°C to 100°C and a V_{DD} range of 4.5 V to 30 V. Low I_F and wide V_{DD} range allow compatibility with TTL, LSTTL, and CMOS logic and result in lower power consumption compared to other high speed optocouplers.

Features

- Maximum Threshold Input Current, I_{FLH}
 - ◆ FOD8480 – 5.5 mA
 - ◆ FOD8482 – 3.0 mA
- FOD8480T and FOD8482T – 8 mm Creepage and Clearance Distance, and 0.4 mm Insulation Distance to Achieve Reliable and High Voltage Insulation
- High Noise Immunity Characterized by Common Mode Transient Immunity (CMTI)
- 20 kV/ μs Minimum CMTI
- Wide Operating Voltage Range, 4.5 V to 30 V
- Specifications Guaranteed Over Extended Industrial Temperature Range, -40 to 100°C
- Safety and Regulatory Approvals
 - ◆ UL1577, 5,000 VAC_{RMS} for 1 Min.
 - ◆ DIN-EN/IEC60747-5-5, 1,140 V Peak Working Insulation Voltage

Typical Applications

- Isolating Intelligent Power Module
- Isolating Industrial Communication Interface



ON Semiconductor®

www.onsemi.com

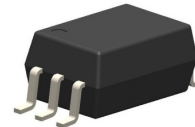

SOIC6
SUFFIX
CASE 751EL

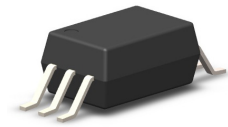

SOIC6 W
SUFFIX
CASE 751EM

MARKING DIAGRAM

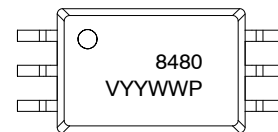

8480 or 8482 = Specific Device Number
V = DIN EN/IEC60747-5-5 Option
YY = Two Digit Year Code
WW = Two Digit Work Week
P = Assembly Package Code

PIN CONNECTIONS

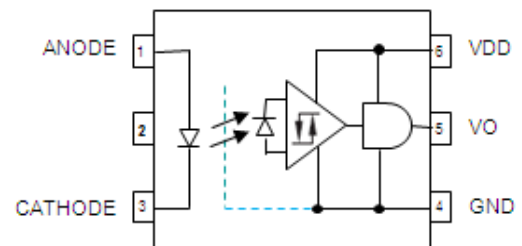

TRUTH TABLE

LED	V_o
Off	Low
On	High

ORDERING INFORMATION

See detailed ordering, marking and shipping information in the package dimensions section on page 10 of this data sheet.

FOD8480, FOD8482

Table 1. SAFETY AND INSULATION RATINGS for Stretched Body SOP 6-Pin

As per DIN EN/IEC60747-5-5. This optocoupler is suitable for "safe electrical insulation" only within the safety limit data. Compliance with the safety ratings shall be ensured by means of protective circuits.

Parameter	Symbol	FOD8480 FOD8482	FOD8480T FOD8482T	Unit
Installation Classifications per DIN VDE 0110/1.89 Table 1, for rated main voltage <150 Vrms		I-IV	I-IV	
for rated main voltage <300 Vrms		I-IV	I-IV	
for rated main voltage <450 Vrms		I-III	I-IV	
for rated main voltage <600 Vrms		I-III	I-III	
Climatic Classification		40/100/21	40/100/21	
Pollution Degree (DIN VDE 0110/1.89)		2	2	
Comparative Tracking Index	CTI	175	175	
Input to Output Test Voltage, Method b, VIORM*1.875=VPR, 100% Production Test with tm=1 sec, Partial Discharge <5 pC	VPR	1,671	2,137	Vpeak
Input to Output Test Voltage, Method a, VIORM*1.6 = VPR, Type and Sample Test with tm = 10 sec, Partial Discharge <5 pC	VPR	1,426	1,824	Vpeak
Max Working Insulation Voltage	VIORM	891	1,140	Vpeak
Highest Allowable Over Voltage	VIOTM	6,000	8,000	Vpeak
External Clearance		7.0	8.0	mm
External Creepage		8.0	8.0	mm
Insulation thickness		0.4	0.4	mm
Insulation Resistance at Ts, VIO = 500 V	RIO	10 ⁹	10 ⁹	Ω
Safety Limit Values- Maximum Values allowed in the event of a failure,				
Case Temperature	Ts	150	150	°C
Input Current	IS,INPUT	200	200	mA
Output Power	PS,OUTPUT	600	600	mW

FOD8480, FOD8482

Table 2. ABSOLUTE MAXIMUM RATINGS ($T_A = 25^\circ\text{C}$ unless otherwise specified)

Symbol	Parameter	Value	Units
T_{STG}	Storage Temperature	-40 to +125	$^\circ\text{C}$
T_{OPR}	Operating Temperature	-40 to +100	$^\circ\text{C}$
T_J	Junction Temperature	-40 to +125	$^\circ\text{C}$
T_{SOL}	Lead Solder Temperature (Refer to Reflow Temperature Profile)	260 for 10 sec	$^\circ\text{C}$

INPUT CHARACTERISTICS

I_F	Average Forward Input Current	20	mA
V_R	Reverse Input Voltage	5.0	V
PD_I	Input Power Dissipation (Notes 1, 3)	35	mW

OUTPUT CHARACTERISTICS

V_{DD}	Supply Voltage	0 to 35	V
V_O	Output Voltage	-0.5 to V_{DD}	V
I_O	Average Output Current	25	mA
PD_O	Output Power Dissipation (Notes 2, 3)	300	mW

Stresses exceeding those listed in the Maximum Ratings table may damage the device. If any of these limits are exceeded, device functionality should not be assumed, damage may occur and reliability may be affected.

Table 3. RECOMMENDED OPERATING CONDITIONS

Symbol	Parameter	Min	Max	Unit
T_A	Ambient Operating Temperature	-40	+100	$^\circ\text{C}$
V_{DD}	Supply Voltages (Note 4)	4.5	30	V
$V_{F(OFF)}$	Forward Input Voltage (OFF)	0	0.8	V
$I_{F(ON)}$	Forward Input Current (ON) (Note 5)	6.6	10	mA
		3.6	7.5	mA

Functional operation above the stresses listed in the Recommended Operating Ranges is not implied. Extended exposure to stresses beyond the Recommended Operating Ranges limits may affect device reliability.

1. No derating required across operating temperature range.
2. Derate linearly from 25°C at a rate of $2.87\text{ mW}/^\circ\text{C}$.
3. Functional operation under these conditions is not implied. Permanent damage may occur if the device is subjected to conditions outside these ratings.
4. $0.1\ \mu\text{F}$ bypass capacitor must be connected between Pin 4 and 6.
5. For FOD8480, the initial switching threshold is 5.5 mA or less. It is recommended that 6.6 mA be used to permit at least a 20% CTR degradation guard band. For FOD8482, the initial switching threshold is 3.0 mA or less. It is recommended that 3.6 mA be used to permit at least a 20% CTR degradation guard band.

Table 4. ISOLATION CHARACTERISTICS (Apply over all recommended conditions, typical value is measured at $T_A = 25^\circ\text{C}$)

Symbol	Parameter	Conditions	Min	Typ	Max	Units
V_{ISO}	Input-Output Isolation Voltage	$T_A = 25^\circ\text{C}$, R.H. < 50%, $t = 1.0\text{ min}$, $I_{I-O} \leq 2\ \mu\text{A}$ (Notes 6, 7)	5,000			VAC _{RMS}
R_{ISO}	Isolation Resistance	$V_{I-O} = 500\text{ V}$ (Note 6)		10^{11}		Ω
C_{ISO}	Isolation Capacitance	$V_{I-O} = 0\text{ V}$, freq = 1.0 MHz (Note 6)		1.0		pF

6. Device is considered a two terminal device: Pins 1, 2 and 3 are shorted together and Pins 4, 5, and 6 are shorted together.
7. 5,000 VAC_{RMS} for 1 minute duration is equivalent to 6,000 VAC_{RMS} for 1 second duration.

FOD8480, FOD8482

Table 5. ELECTRICAL CHARACTERISTICS (Apply over all recommended conditions, $T_A = -40^{\circ}\text{C}$ to $+100^{\circ}\text{C}$, $4.5\text{ V} \leq V_{DD} \leq 30\text{ V}$, FOD8480: $I_{F(ON)} = 6\text{ mA}$ to 10 mA , FOD8482: $I_{F(ON)} = 4\text{ mA}$ to 7 mA , $V_{F(OFF)} = 0$ to 0.8 V , unless otherwise specified. Typical value is measured at $T_A = 25^{\circ}\text{C}$ and $V_{DD} = 5\text{ V}$.)

Symbol	Parameter	Conditions	Min	Typ	Max	Units
INPUT CHARACTERISTICS						
V_F	Forward Voltage	$I_F = 6\text{ mA}$		1.4	1.75	V
BV_R	Reverse Breakdown Voltage	$I_R = 10\text{ }\mu\text{A}$	5.0			V
C_{IN}	Input Capacitance	$V_F = 0$, $f = 1\text{ MHz}$		60		pF
$\Delta V_F/\Delta T_A$	Input Diode Temperature Coefficient	$I_F = 6\text{ mA}$		-1.4		mV/ $^{\circ}\text{C}$
I_{FLH}	Threshold Input Current Low to High	FOD8480		2.2	5.5	mA
		FOD8482		1.45	3.0	mA
I_{HYS}	Input Current Hysteresis	$V_{DD} = 5\text{ V}$		0.3		mA

OUTPUT CHARACTERISTICS

I_{DDH}	Logic High Output Supply Current	$V_{DD} = 5\text{ V}$, $I_F = 10\text{ mA}$		1.6	2.5	mA
		$V_{DD} = 30\text{ V}$, $I_F = 10\text{ mA}$		1.8	2.5	mA
I_{DDL}	Logic Low Output Supply Current	$V_{DD} = 5\text{ V}$, $I_F = 0\text{ mA}$		1.6	2.5	mA
		$V_{DD} = 30\text{ V}$, $I_F = 0\text{ mA}$		1.8	2.5	mA
I_{OSH}	Logic High Short Circuit Output Current	$V_{DD} = 5.5\text{ V}$, $I_F = 10\text{ mA}$, $V_O = \text{GND}$			-80	mA
		$V_{DD} = 30\text{ V}$, $I_F = 10\text{ mA}$, $V_O = \text{GND}$			-80	mA
I_{OSL}	Logic Low Short Circuit Output Current	$V_{DD} = V_O = 5.5\text{ V}$, $V_F = 0\text{ V}$	80			mA
		$V_{DD} = V_O = 30\text{ V}$, $V_F = 0\text{ V}$	80			mA
V_{OH}	Logic High Output Voltage	$I_{OH} = -2.6\text{ mA}$	$V_{DD} - 0.1$	$V_{DD} - 0.04$		V
		$I_{OH} = -0.4\text{ mA}$	$V_{DD} - 0.1$	$V_{DD} - 0.01$		V
V_{OL}	Logic Low Output Voltage	$I_{OL} = 6.4\text{ mA}$, $V_F = 0\text{ V}$			0.5	V

Product parametric performance is indicated in the Electrical Characteristics for the listed test conditions, unless otherwise noted. Product performance may not be indicated by the Electrical Characteristics if operated under different conditions.

Table 6. SWITCHING CHARACTERISTICS (Apply over all recommended conditions, $T_A = -40^{\circ}\text{C}$ to $+100^{\circ}\text{C}$, $4.5\text{ V} \leq V_{DD} \leq 30\text{ V}$, FOD8480: $I_{F(ON)} = 6\text{ mA}$ to 10 mA , FOD8482: $I_{F(ON)} = 4\text{ mA}$ to 7 mA , $V_{F(OFF)} = 0$ to 0.8 V , unless otherwise specified. Typical value is measured at $T_A = 25^{\circ}\text{C}$ and $V_{DD} = 5\text{ V}$.)

Symbol	Parameter	Conditions	Min	Typ	Max	Units
Date Rate					1	Mbit/s
t_{PHL}	Propagation Delay Time to Logic Low Output	With peaking capacitor, $C_L = 15\text{ pF}$		130	300	ns
t_{PLH}	Propagation Delay Time to Logic High Output	With peaking capacitor, $C_L = 15\text{ pF}$		100	300	ns
PWD	Pulse Width Distortion, $ t_{PHL} - t_{PLH} $	With peaking capacitor, $C_L = 15\text{ pF}$			250	ns
t_{PSK}	Propagation Delay Skew (Note 8)	With peaking capacitor, $C_L = 15\text{ pF}$			150	ns
t_R	Output Rise Time (10% – 90%)			15		ns
t_F	Output Fall Time (90% – 10%)			10		ns
$ CM_H $	Common Mode Transient Immunity at Output High	$I_F = I_{F(ON)}$, $V_O > 2.0\text{ V}$, $V_{CM} = 1000\text{ V}$, $T_A = 25^{\circ}\text{C}$ (Note 9)	20	40		kV/ μs
$ CM_L $	Common Mode Transient Immunity at Output Low	$I_F = 0\text{ mA}$, $V_O < 0.8\text{ V}$, $V_{CM} = 1000\text{ V}$, $T_A = 25^{\circ}\text{C}$ (Note 9)	20	40		kV/ μs

8. t_{PSK} is equal to the magnitude of the worst case difference in t_{PHL} and/or t_{PLH} that will be seen between any two units from the same manufacturing date code that are operated at same case temperature ($\pm 5^{\circ}\text{C}$), at same operating conditions, with equal loads ($C_L = 15\text{ pF}$), and with an input rise time less than 5 ns.
9. Common mode transient immunity at output high is the maximum tolerable negative dV_{cm}/dt on the trailing edge of the common mode impulse signal, V_{cm} , to assure that the output will remain high. Common mode transient immunity at output low is the maximum tolerable positive dV_{cm}/dt on the leading edge of the common pulse signal, V_{cm} , to assure that the output will remain low.

FOD8480, FOD8482

TYPICAL CHARACTERISTICS

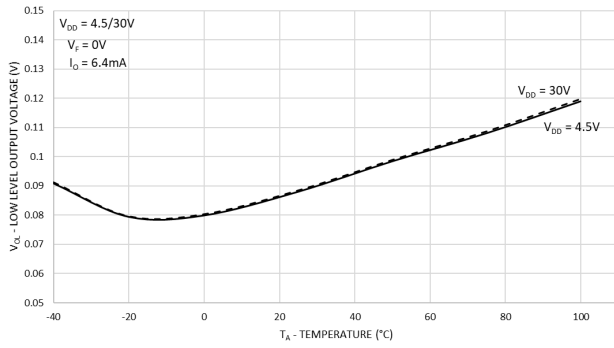

Figure 1. Typical Logic Low Output Voltage vs. Temperature



Figure 2. Typical Logic High Output Current vs. Temperature

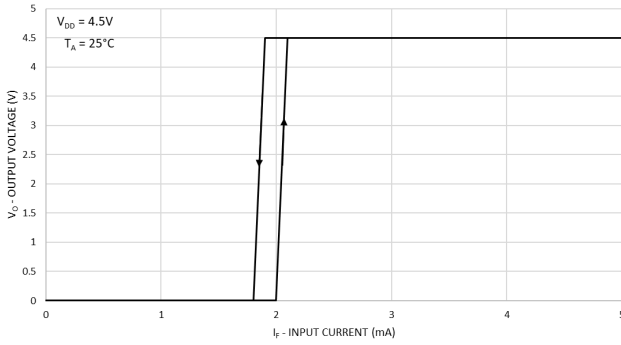

Figure 3. Typical Output Voltage vs. Forward Input Current (FOD8480)



Figure 4. Typical Output Voltage vs. Forward Input Current (FOD8482)

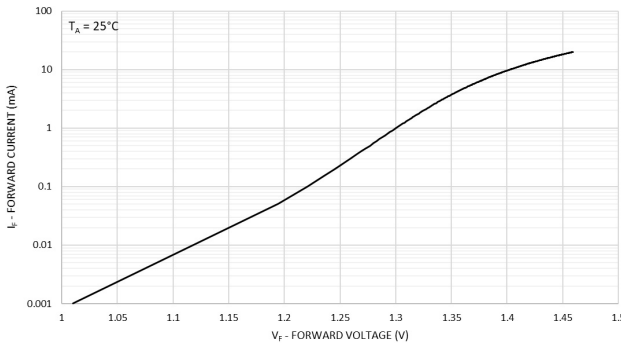

Figure 5. Typical Input Diode Forward Characteristic

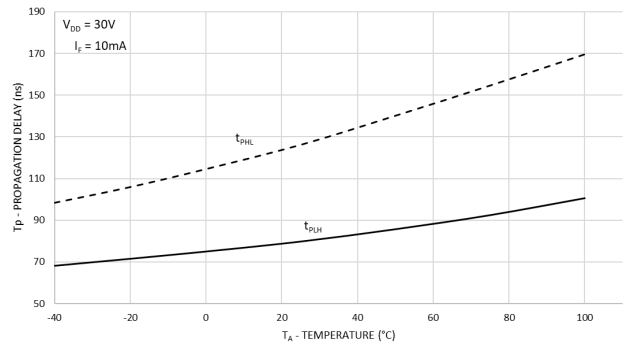

Figure 6. Typical Propagation Delay vs. Temperature

FOD8480, FOD8482

TYPICAL CHARACTERISTICS

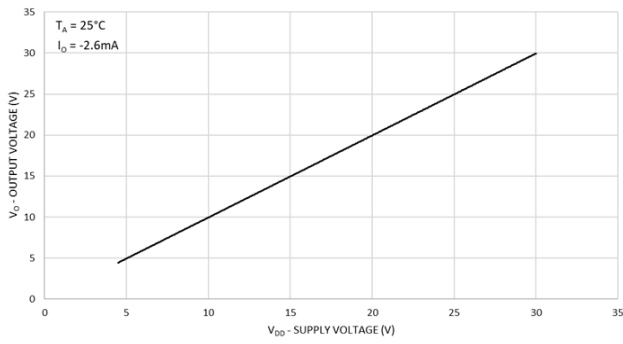

Figure 7. Typical Logic High Output Voltage vs. Supply Voltage



Figure 8. Typical Propagation Delay vs. Supply Voltage

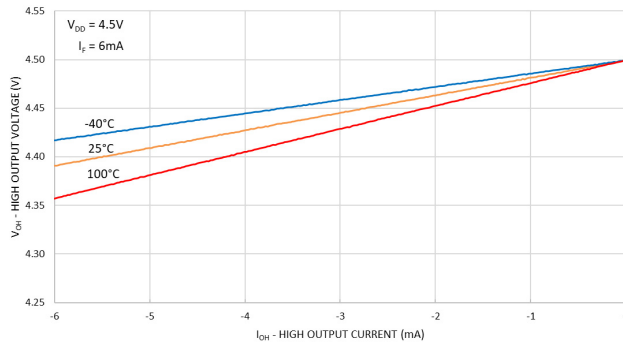

Figure 9. V_{OH} vs. I_{OH} Across Temperatures

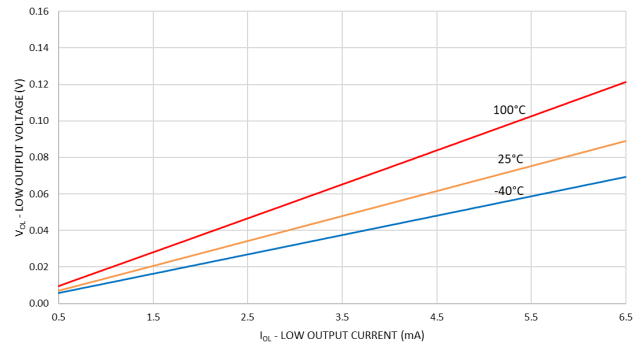

Figure 10. V_{OL} vs. I_{OL} Across Temperatures

FOD8480, FOD8482



Figure 11. Test Circuit for Propagation Delay, Rise Time and Fall Time

FOD8480, FOD8482

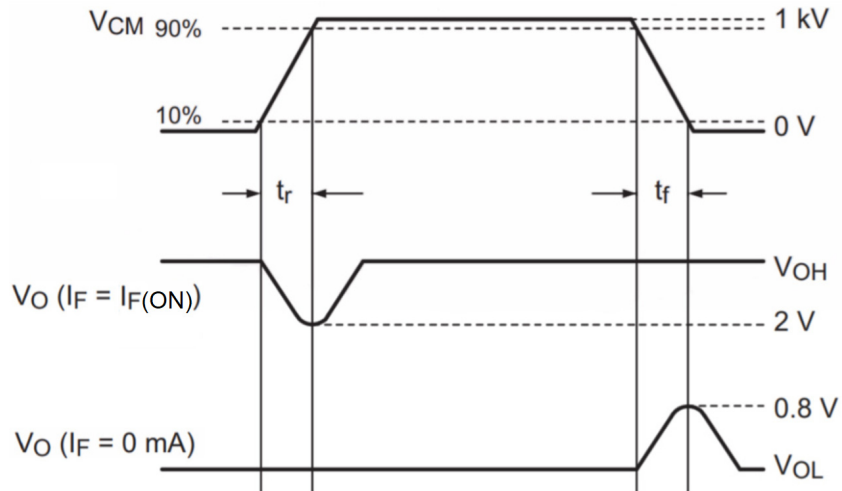
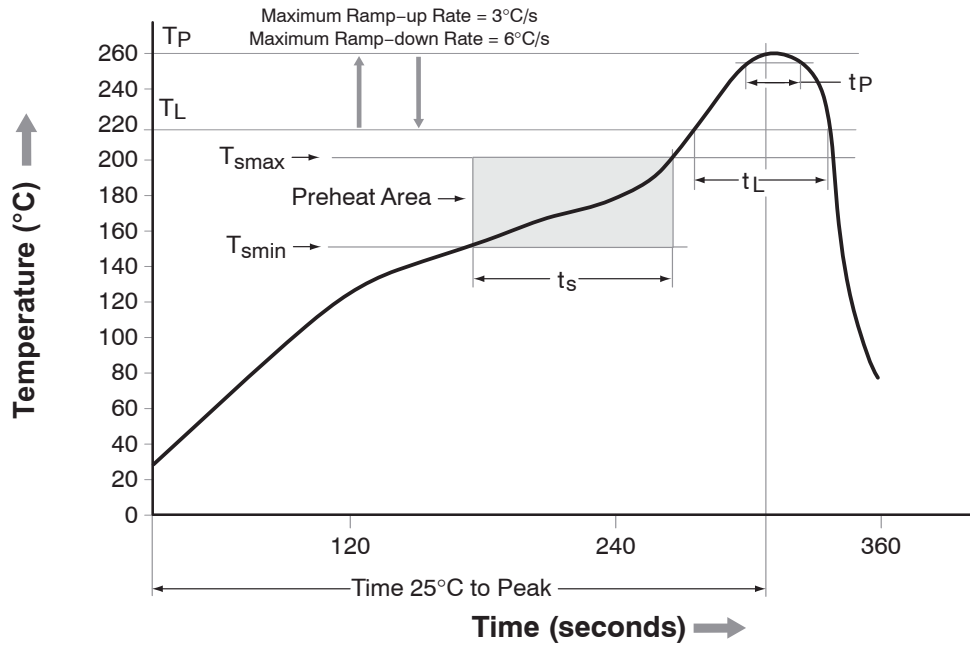

Figure 12. Test Circuit for Instantaneous Common-Mode Rejection Voltage

Reflow Profile



Profile Feature	Pb-Free Assembly Profile
Temperature Minimum (T_{smin})	150°C
Temperature Maximum (T_{smax})	200°C
Time (t_s) from (T_{smin} to T_{smax})	60 s to 120 s
Ramp-up Rate (t_L to t_P)	3°C/second maximum
Liquidous Temperature (T_L)	217°C
Time (t_L) Maintained Above (T_L)	60 s to 150 s
Peak Body Package Temperature	260°C +0°C / -5°C
Time (t_p) within 5°C of 260°C	30 s
Ramp-Down Rate (T_P to T_L)	6°C/s maximum
Time 25°C to Peak Temperature	8 minutes maximum

Figure 13. Reflow Profile

FOD8480, FOD8482

ORDERING INFORMATION

Part Number	Package	Packing Method
FOD8480	Stretched Body SOP 6-Pin	Tube (100 units per tube)
FOD8480R2	Stretched Body SOP 6-Pin	Tape and Reel (1,000 units per reel)
FOD8480V	Stretched Body SOP 6-Pin, DIN EN/IEC60747-5-5 Option	Tube (100 units per tube)
FOD8480R2V	Stretched Body SOP 6-Pin, DIN EN/ IEC60747-5-5 Option	Tape and Reel (1,000 units per reel)
FOD8480T	Stretched Body SOP 6-Pin, Wide Lead	Tube (100 units per tube)
FOD8480TR2	Stretched Body SOP 6-Pin, Wide Lead	Tape and Reel (1,000 units per reel)
FOD8480TV	Stretched Body SOP 6-Pin, Wide Lead, DIN EN/IEC60747-5-5 Option	Tube (100 units per tube)
FOD8480TR2V	Stretched Body SOP 6-Pin, Wide Lead, DIN EN/ IEC60747-5-5 Option	Tape and Reel (1,000 units per reel)

*All packages are lead free per JEDEC: J-STD-020B standard.

MECHANICAL CASE OUTLINE
PACKAGE DIMENSIONS

ON Semiconductor®



SOIC6
CASE 751EL
ISSUE O

DATE 30 SEP 2016



RECOMMENDED LAND PATTERN



NOTES: UNLESS OTHERWISE SPECIFIED

- A) NO STANDARD APPLIES TO THIS PACKAGE
- B) ALL DIMENSIONS ARE IN MILLIMETERS.
- C) DIMENSIONS DO NOT INCLUDE BURRS OR MOLD FLASH, AND TIE BAR EXTRUSION.
- D) DIMENSIONING AND TOLERANCING PER ASME Y14.5M-2009.

DOCUMENT NUMBER:	98AON13745G	Electronic versions are uncontrolled except when accessed directly from the Document Repository. Printed versions are uncontrolled except when stamped "CONTROLLED COPY" in red.
DESCRIPTION:	SOIC6	PAGE 1 OF 1

ON Semiconductor and are trademarks of Semiconductor Components Industries, LLC dba ON Semiconductor or its subsidiaries in the United States and/or other countries. ON Semiconductor reserves the right to make changes without further notice to any products herein. ON Semiconductor makes no warranty, representation or guarantee regarding the suitability of its products for any particular purpose, nor does ON Semiconductor assume any liability arising out of the application or use of any product or circuit, and specifically disclaims any and all liability, including without limitation special, consequential or incidental damages. ON Semiconductor does not convey any license under its patent rights nor the rights of others.

MECHANICAL CASE OUTLINE
PACKAGE DIMENSIONS

ON Semiconductor®



SOIC6 W
CASE 751EM
ISSUE O

DATE 30 SEP 2016



RECOMMENDED LAND PATTERN

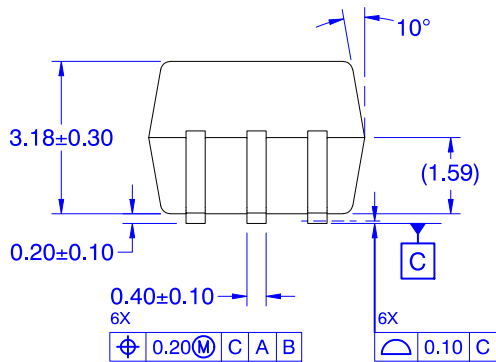

- NOTES: UNLESS OTHERWISE SPECIFIED**
- A) NO STANDARD APPLIES TO THIS PACKAGE
 - B) ALL DIMENSIONS ARE IN MILLIMETERS.
 - C) DIMENSIONS DO NOT INCLUDE BURRS OR MOLD FLASH, AND TIE BAR EXTRUSION.
 - D) DIMENSIONING AND TOLERANCING PER ASME Y14.5M-2009.

DOCUMENT NUMBER:	98AON13749G	Electronic versions are uncontrolled except when accessed directly from the Document Repository. Printed versions are uncontrolled except when stamped "CONTROLLED COPY" in red.
DESCRIPTION:	SOIC6 W	PAGE 1 OF 1

ON Semiconductor and are trademarks of Semiconductor Components Industries, LLC dba ON Semiconductor or its subsidiaries in the United States and/or other countries. ON Semiconductor reserves the right to make changes without further notice to any products herein. ON Semiconductor makes no warranty, representation or guarantee regarding the suitability of its products for any particular purpose, nor does ON Semiconductor assume any liability arising out of the application or use of any product or circuit, and specifically disclaims any and all liability, including without limitation special, consequential or incidental damages. ON Semiconductor does not convey any license under its patent rights nor the rights of others.

ON Semiconductor and  are trademarks of Semiconductor Components Industries, LLC dba ON Semiconductor or its subsidiaries in the United States and/or other countries. ON Semiconductor owns the rights to a number of patents, trademarks, copyrights, trade secrets, and other intellectual property. A listing of ON Semiconductor's product/patent coverage may be accessed at www.onsemi.com/site/pdf/Patent-Marking.pdf. ON Semiconductor reserves the right to make changes without further notice to any products herein. ON Semiconductor makes no warranty, representation or guarantee regarding the suitability of its products for any particular purpose, nor does ON Semiconductor assume any liability arising out of the application or use of any product or circuit, and specifically disclaims any and all liability, including without limitation special, consequential or incidental damages. Buyer is responsible for its products and applications using ON Semiconductor products, including compliance with all laws, regulations and safety requirements or standards, regardless of any support or applications information provided by ON Semiconductor. "Typical" parameters which may be provided in ON Semiconductor data sheets and/or specifications can and do vary in different applications and actual performance may vary over time. All operating parameters, including "Typicals" must be validated for each customer application by customer's technical experts. ON Semiconductor does not convey any license under its patent rights nor the rights of others. ON Semiconductor products are not designed, intended, or authorized for use as a critical component in life support systems or any FDA Class 3 medical devices or medical devices with a same or similar classification in a foreign jurisdiction or any devices intended for implantation in the human body. Should Buyer purchase or use ON Semiconductor products for any such unintended or unauthorized application, Buyer shall indemnify and hold ON Semiconductor and its officers, employees, subsidiaries, affiliates, and distributors harmless against all claims, costs, damages, and expenses, and reasonable attorney fees arising out of, directly or indirectly, any claim of personal injury or death associated with such unintended or unauthorized use, even if such claim alleges that ON Semiconductor was negligent regarding the design or manufacture of the part. ON Semiconductor is an Equal Opportunity/Affirmative Action Employer. This literature is subject to all applicable copyright laws and is not for resale in any manner.

PUBLICATION ORDERING INFORMATION

LITERATURE FULFILLMENT:

Email Requests to: orderlit@onsemi.com

ON Semiconductor Website: www.onsemi.com

TECHNICAL SUPPORT

North American Technical Support:
Voice Mail: 1 800-282-9855 Toll Free USA/Canada
Phone: 011 421 33 790 2910

Europe, Middle East and Africa Technical Support:

Phone: 00421 33 790 2910

For additional information, please contact your local Sales Representative

Mouser Electronics

Authorized Distributor

Click to View Pricing, Inventory, Delivery & Lifecycle Information:

ON Semiconductor:

[FOD8480](#) [FOD8480R2](#) [FOD8480T](#) [FOD8480TR2](#) [FOD8482](#) [FOD8482TR2](#) [FOD8482T](#) [FOD8482R2](#)
[FOD8480R2V](#) [FOD8480V](#)