

# Bridgelux® GENG V6 Array Series

Product Data Sheet DS1307



# Introduction

V Series

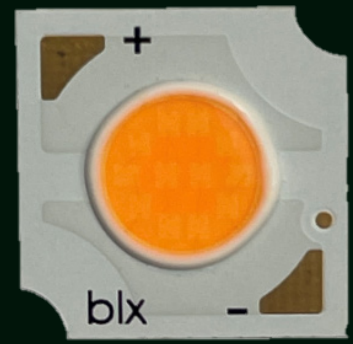

The V Series™ LED Array products deliver high quality light in a compact and cost-effective solid-state lighting package. These chip on board (CoB) arrays can be efficiently driven more than two times the nominal drive current, enabling design flexibility not previously possible. These high flux density light sources are designed to support a wide range of high quality, low cost directional luminaires and replacement lamps for both interior and exterior commercial and residential applications.

The Gen 9 V Series COB is a high efficacy product that uses narrow band red phosphor to significantly improve the spectrum efficacy. The improved spectrum efficacy results in the 80 CRI product of the Gen 9 Series delivering better or equivalent efficacy as that of our previous generation V Series product.

The V6 LED Array is available in a variety of electrical, CCT, and CRI combinations providing substantial design flexibility and energy efficiency advantages.

Lighting system designs incorporating these LED arrays deliver increased system level efficacy and a longer service life. Typical applications include replacement lamps and task, accent, spot, track, wide area, security, wall packs and down lights.

## Features

- Efficacy of 186 lm/W typical, 3000K 80 CRI
- Wide selection of CCT options (2700K-5000K) with minimum 80 CRI options
- Uniform high-quality illumination
- 2 and 3 SDCM binning options (2700K – 4000K)
- 3 and 4 SDCM binning options (5000K)
- Forward voltage bin codes and backside marking
- Instant light with unlimited dimming
- 5-Year warranty

## Benefits

- Enables high efficiency lighting systems and lower operating costs
- Supports the trend toward luminaire miniaturization and delivers enhanced optical control
- Design flexibility for a broad range of lighting applications
- Clean white light without pixelation
- Uniform consistent white light
- Design flexibility for multi-source applications
- Easy to use with daylight and motion sensors to increase energy savings
- Design with confidence



# Contents

Product Feature Map	2
Product Nomenclature	2
Product Selection Guide	3
European Product Registry for Energy Labeling	5
Performance at Commonly Used Drive Currents	6
Electrical Characteristics	9
Eye Safety	10
Absolute Maximum Ratings	11
Performance Curves	12
Typical Radiation Pattern	14
Typical Color Spectrum	15
Mechanical Dimensions	17
Color Binning Information	18
Packaging and Labeling	19
Design Resources	21
Precautions	21
Disclaimers	21
About Bridgelux	22

# Product Feature Map

Bridgelux arrays are fully engineered devices that provide consistent thermal and optical performance on an engineered mechanical platform. The V Series arrays are the most compact CoB devices across all of Bridgelux's LED Array products.

The arrays incorporate several features to simplify design integration and assembly. Please visit [www.bridgelux.com](http://www.bridgelux.com) for more information on the V Series family of products.

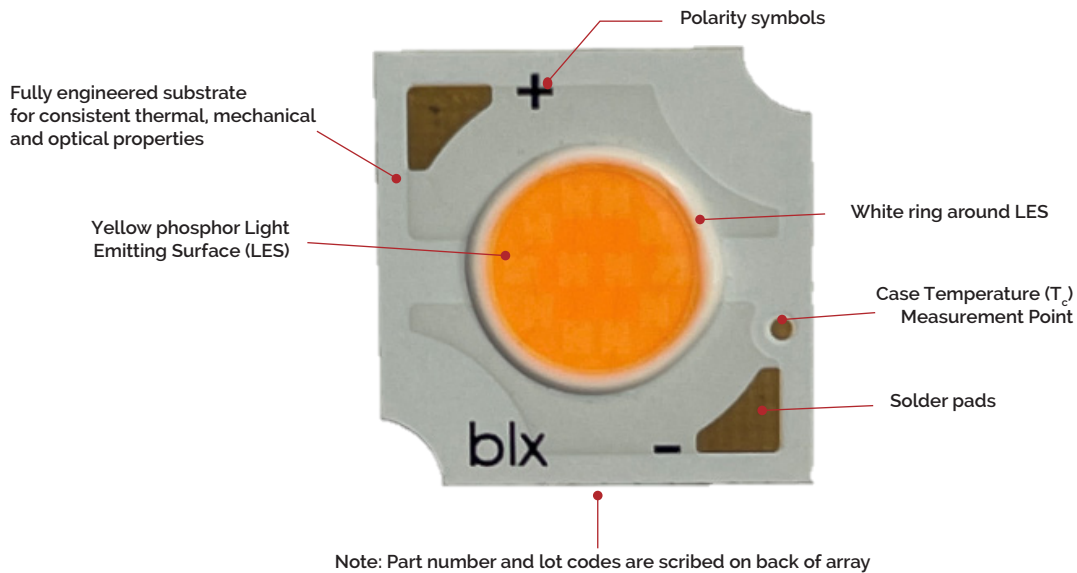

## Product Nomenclature

The part number designation for Bridgelux V Series LED arrays is explained as follows:

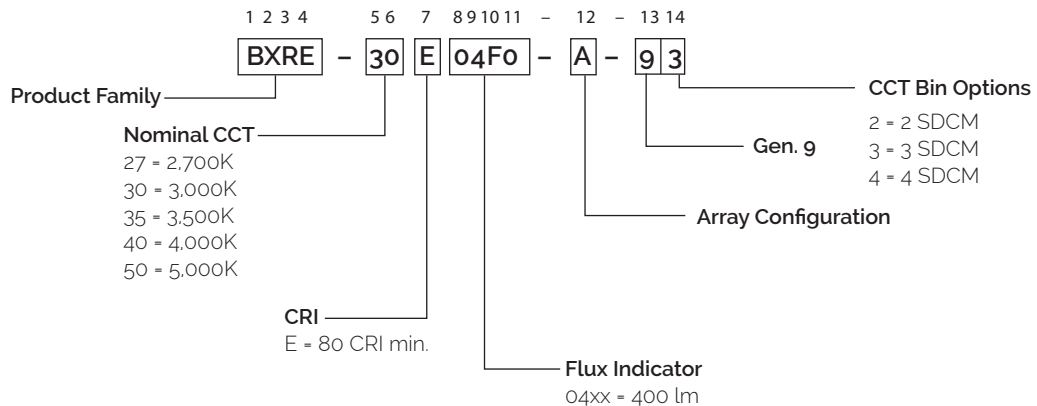

# Product Selection Guide

The following product configurations are available:

**Table 1:** Selection Guide, Pulsed Measurement Data ( $T_j = T_c = 25^\circ\text{C}$ )

Part Number	Nominal CCT <sup>1</sup> (K)	CRI <sup>2</sup>	Nominal Drive Current <sup>3</sup> (mA)	Typical Pulsed Flux <sup>4,5,6</sup> $T_c = 25^\circ\text{C}$ (lm)	Minimum Pulsed Flux <sup>6,7</sup> $T_c = 25^\circ\text{C}$ (lm)	Typical $V_f$ (V)	Typical Power (W)	Typical Efficacy (lm/W)
BXRE-27E04F0-A-gx	2700	80	160	495	445	17.0	2.7	182
BXRE-27E04F0-B-gx	2700	80	320	495	445	8.5	2.7	182
BXRE-27E04F0-C-gx	2700	80	80	495	445	33.9	2.7	182
BXRE-30E04F0-A-gx	3000	80	160	505	455	17.0	2.7	186
BXRE-30E04F0-B-gx	3000	80	320	505	455	8.5	2.7	186
BXRE-30E04F0-C-gx	3000	80	80	505	455	33.9	2.7	186
BXRE-35E04F0-A-gx	3500	80	160	508	457	17.0	2.7	187
BXRE-35E04F0-B-gx	3500	80	320	508	457	8.5	2.7	187
BXRE-35E04F0-C-gx	3500	80	80	508	457	33.9	2.7	187
BXRE-40E04F0-A-gx	4000	80	160	510	459	17.0	2.7	188
BXRE-40E04F0-B-gx	4000	80	320	510	459	8.5	2.7	188
BXRE-40E04F0-C-gx	4000	80	80	510	459	33.9	2.7	188
BXRE-50E04F0-A-gx	5000	80	160	500	450	17.0	2.7	184
BXRE-50E04F0-B-gx	5000	80	320	500	450	8.5	2.7	184
BXRE-50E04F0-C-gx	5000	80	80	500	450	33.9	2.7	184

Notes for Table 1:

- Nominal CCT as defined by ANSI C78.377-2011.
- CRI values are minimums and tested at  $T_j = T_c = 85^\circ\text{C}$ . Minimum Rg value for 80 CRI products is 0. Bridgelux maintains a  $\pm 3$  tolerance on CRI and Rg values.
- Drive current is referred to as nominal drive current.
- Products tested under pulsed condition (10ms pulse width) at nominal drive current where  $T_j$  (junction temperature) -  $T_c$  (case temperature) =  $25^\circ\text{C}$ .
- Typical performance values are provided as a reference only and are not a guarantee of performance.
- Bridgelux maintains a  $\pm 7\%$  tolerance on flux measurements.
- Minimum flux values at the nominal drive current are guaranteed by 100% test.

# Product Selection Guide

**Table 2:** Selection Guide, Stabilized DC Performance ( $T_c = 85^\circ\text{C}$ )<sup>4,5</sup>

Part Number	Nominal CCT <sup>1</sup> (K)	CRI <sup>2</sup>	Nominal Drive Current <sup>3</sup> (mA)	Typical DC Flux <sup>4,5</sup> $T_c = 85^\circ\text{C}$ (lm)	Minimum DC Flux <sup>6</sup> $T_c = 85^\circ\text{C}$ (lm)	Typical $V_f$ (V)	Typical Power (W)	Typical Efficacy (lm/W)
BXRE-27E04F0-A-gx	2700	80	160	455	410	16.7	2.7	170
BXRE-27E04F0-B-gx	2700	80	320	455	410	8.4	2.7	170
BXRE-27E04F0-C-gx	2700	80	80	455	410	33.3	2.7	171
BXRE-30E04F0-A-gx	3000	80	160	465	418	16.7	2.7	174
BXRE-30E04F0-B-gx	3000	80	320	465	418	8.4	2.7	174
BXRE-30E04F0-C-gx	3000	80	80	465	418	33.3	2.7	174
BXRE-35E04F0-A-gx	3500	80	160	467	420	16.7	2.7	175
BXRE-35E04F0-B-gx	3500	80	320	467	420	8.4	2.7	175
BXRE-35E04F0-C-gx	3500	80	80	467	420	33.3	2.7	175
BXRE-40E04F0-A-gx	4000	80	160	469	422	16.7	2.7	176
BXRE-40E04F0-B-gx	4000	80	320	469	422	8.4	2.7	176
BXRE-40E04F0-C-gx	4000	80	80	469	422	33.3	2.7	176
BXRE-50E04F0-A-gx	5000	80	160	460	414	16.7	2.7	172
BXRE-50E04F0-B-gx	5000	80	320	460	414	8.4	2.7	172
BXRE-50E04F0-C-gx	5000	80	80	460	414	33.3	2.7	173

Notes for Table 2:

1. Nominal CCT as defined by ANSI C78.377-2011.
2. CRI values are minimums and tested at  $T_j = T_c = 85^\circ\text{C}$ . Minimum Rg value for 80 CRI products is 0, Bridgelux maintains a  $\pm 3$  tolerance on CRI and Rg values.
3. Drive current is referred to as nominal drive current.
4. Typical stabilized DC performance values are provided as reference only and are not a guarantee of performance.
5. Typical performance is estimated based on operation under DC (direct current) with LED array mounted onto a heat sink with thermal interface material and the case temperature maintained at  $85^\circ\text{C}$ . Based on Bridgelux test setup, values may vary depending on the thermal design of the luminaire and/or the exposed environment to which the product is subjected.
6. Minimum flux values at elevated temperatures are provided for reference only and are not guaranteed by 100% production testing. Based on Bridgelux test setup, values may vary depending on the thermal design of the luminaire and/or the exposed environment to which the product is subjected.



# Performance at Commonly Used Drive Currents

V Series LED arrays are tested to the specifications shown using the nominal drive currents in Table 1. V Series may also be driven at other drive currents dependent on specific application design requirements. The performance at any drive current can be derived from the current vs. voltage characteristics shown in Figures 1, 2 & 3 and the flux vs. current characteristics shown in Figures 4, 5 & 6. The performance at commonly used drive currents is summarized in Table 4.

**Table 4:** Product Performance at Commonly Used Drive Currents

Part Number	CRI	Drive Current <sup>1</sup> (mA)	Typical $V_f$ $T_c = 25^\circ\text{C}$ (V)	Typical Power $T_c = 25^\circ\text{C}$ (W)	Typical Flux <sup>2</sup> $T_c = 25^\circ\text{C}$ (lm)	Typical DC Flux <sup>3</sup> $T_c = 85^\circ\text{C}$ (lm)	Typical Efficacy $T_c = 25^\circ\text{C}$ (lm/W)
BXRE-27E04F0-A-gx	80	40	15.7	0.6	128	119	203
		80	16.2	1.3	255	237	197
		120	16.6	2.0	377	349	189
		<b>160</b>	<b>17.0</b>	<b>2.7</b>	<b>495</b>	<b>455</b>	<b>182</b>
		240	17.7	4.2	721	654	170
		360	18.7	6.7	1044	931	155
BXRE-27E04F0-B-gx	80	100	7.9	0.8	160	149	202
		200	8.2	1.6	316	294	193
		240	8.3	2.0	377	349	189
		<b>320</b>	<b>8.5</b>	<b>2.7</b>	<b>495</b>	<b>455</b>	<b>182</b>
		540	9.0	4.8	803	725	166
		720	9.4	6.7	1044	931	155
BXRE-27E04F0-C-gx	80	20	31.3	0.6	128	119	204
		40	32.3	1.3	255	237	197
		60	33.1	2.0	377	349	190
		<b>80</b>	<b>33.9</b>	<b>2.7</b>	<b>495</b>	<b>455</b>	<b>182</b>
		120	35.3	4.2	721	654	170
		180	37.3	6.7	1044	931	156
BXRE-30E04F0-A-gx	80	40	15.7	0.6	130	122	207
		80	16.2	1.3	260	242	201
		120	16.6	2.0	385	356	193
		<b>160</b>	<b>17.0</b>	<b>2.7</b>	<b>505</b>	<b>465</b>	<b>186</b>
		240	17.7	4.2	736	668	173
		360	18.7	6.7	1066	950	158
BXRE-30E04F0-B-gx	80	100	7.9	0.8	163	152	206
		200	8.2	1.6	323	300	197
		240	8.3	2.0	385	356	193
		<b>320</b>	<b>8.5</b>	<b>2.7</b>	<b>505</b>	<b>465</b>	<b>186</b>
		540	9.0	4.8	819	740	169
		720	9.4	6.7	1066	950	158
BXRE-30E04F0-C-gx	80	20	31.3	0.6	130	122	208
		40	32.3	1.3	260	242	201
		60	33.1	2.0	385	356	193
		<b>80</b>	<b>33.9</b>	<b>2.7</b>	<b>505</b>	<b>465</b>	<b>186</b>
		120	35.3	4.2	736	668	174
		180	37.3	6.7	1066	950	159

Notes for Table 4:

1. Alternate drive currents in Table 4 are provided for reference only and are not a guarantee of performance.
2. Bridgelux maintains a  $\pm 7\%$  tolerance on flux measurements.
3. Typical stabilized DC performance values are provided as reference only and are not a guarantee of performance.



# Performance at Commonly Used Drive Currents

**Table 4:** Product Performance at Commonly Used Drive Currents (Continued)

Part Number	CRI	Drive Current <sup>1</sup> (mA)	Typical V <sub>f</sub> T <sub>c</sub> = 25°C (V)	Typical Power T <sub>c</sub> = 25°C (W)	Typical Flux <sup>2</sup> T <sub>c</sub> = 25°C (lm)	Typical DC Flux <sup>3</sup> T <sub>c</sub> = 85°C (lm)	Typical Efficacy T <sub>c</sub> = 25°C (lm/W)
BXRE-35E04F0-A-gx	80	40	15.7	0.6	131	122	208
		80	16.2	1.3	261	243	202
		120	16.6	2.0	386	358	194
		<b>160</b>	<b>17.0</b>	<b>2.7</b>	<b>508</b>	<b>467</b>	<b>187</b>
		240	17.7	4.2	739	671	174
		360	18.7	6.7	1071	955	159
BXRE-35E04F0-B-gx	80	100	7.9	0.8	164	153	207
		200	8.2	1.6	324	301	198
		240	8.3	2.0	386	358	194
		<b>320</b>	<b>8.5</b>	<b>2.7</b>	<b>508</b>	<b>467</b>	<b>187</b>
		540	9.0	4.8	824	744	170
		720	9.4	6.7	1071	955	159
BXRE-35E04F0-C-gx	80	20	31.3	0.6	131	122	209
		40	32.3	1.3	261	243	202
		60	33.1	2.0	386	358	194
		<b>80</b>	<b>33.9</b>	<b>2.7</b>	<b>508</b>	<b>467</b>	<b>187</b>
		120	35.3	4.2	739	671	175
		180	37.3	6.7	1071	955	159
BXRE-40E04F0-A-gx	80	40	15.7	0.6	132	123	209
		80	16.2	1.3	262	245	203
		120	16.6	2.0	388	360	195
		<b>160</b>	<b>17.0</b>	<b>2.7</b>	<b>510</b>	<b>469</b>	<b>188</b>
		240	17.7	4.2	743	674	175
		360	18.7	6.7	1076	959	160
BXRE-40E04F0-B-gx	80	100	7.9	0.8	165	154	208
		200	8.2	1.6	326	303	199
		240	8.3	2.0	388	360	195
		<b>320</b>	<b>8.5</b>	<b>2.7</b>	<b>510</b>	<b>469</b>	<b>188</b>
		540	9.0	4.8	828	748	171
		720	9.4	6.7	1076	959	160
BXRE-40E04F0-C-gx	80	20	31.3	0.6	132	123	210
		40	32.3	1.3	262	245	203
		60	33.1	2.0	388	360	195
		<b>80</b>	<b>33.9</b>	<b>2.7</b>	<b>510</b>	<b>469</b>	<b>188</b>
		120	35.3	4.2	743	674	176
		180	37.3	6.7	1076	959	160
BXRE-50E04F0-A-gx	80	40	15.7	0.6	129	120	205
		80	16.2	1.3	257	240	199
		120	16.6	2.0	381	353	191
		<b>160</b>	<b>17.0</b>	<b>2.7</b>	<b>500</b>	<b>460</b>	<b>184</b>
		240	17.7	4.2	728	661	172
		360	18.7	6.7	1055	940	157

Notes for Table 4:

1. Alternate drive currents in Table 4 are provided for reference only and are not a guarantee of performance.

# Performance at Commonly Used Drive Currents

**Table 4:** Product Performance at Commonly Used Drive Currents (Continued)

Part Number	CRI	Drive Current <sup>1</sup> (mA)	Typical $V_f$ $T_c = 25^\circ\text{C}$ (V)	Typical Power $T_c = 25^\circ\text{C}$ (W)	Typical Flux <sup>2</sup> $T_c = 25^\circ\text{C}$ (lm)	Typical DC Flux <sup>3</sup> $T_c = 85^\circ\text{C}$ (lm)	Typical Efficacy $T_c = 25^\circ\text{C}$ (lm/W)
BXRE-50E04F0-B-gx	80	100	7.9	0.8	162	151	204
		200	8.2	1.6	320	297	195
		240	8.3	2.0	381	353	191
		<b>320</b>	<b>8.5</b>	<b>2.7</b>	<b>500</b>	<b>460</b>	<b>184</b>
		540	9.0	4.8	811	733	168
		720	9.4	6.7	1055	940	157
BXRE-50E04F0-C-gx	80	20	31.3	0.6	129	120	206
		40	32.3	1.3	257	240	199
		60	33.1	2.0	381	353	191
		<b>80</b>	<b>33.9</b>	<b>2.7</b>	<b>500</b>	<b>460</b>	<b>184</b>
		120	35.3	4.2	728	661	172
		180	37.3	6.7	1055	940	157

Notes for Table 4:

1. Alternate drive currents in Table 4 are provided for reference only and are not a guarantee of performance.
2. Bridgelux maintains a  $\pm 7\%$  tolerance on flux measurements.
3. Typical stabilized DC performance values are provided as reference only and are not a guarantee of performance.

# Electrical Characteristics

**Table 5:** Electrical Characteristics

Part Number	Drive Current (mA)	Forward Voltage Pulsed, $T_c = 25^\circ\text{C}$ (V) <sup>1, 2, 3, 8</sup>			Typical Coefficient of Forward Voltage <sup>4</sup> $\Delta V_f / \Delta T_c$ (mV/ $^\circ\text{C}$ )	Typical Thermal Resistance Junction to Case <sup>5,6</sup> $R_{j-c}$ ( $^\circ\text{C}/\text{W}$ )	Driver Selection Voltages <sup>7</sup> (V)	
		Minimum	Typical	Maximum			$V_f$ Min. Hot $T_c = 95^\circ\text{C}$ (V)	$V_f$ Max. Cold $T_c = -40^\circ\text{C}$ (V)
BXRE-xxx04Fx-A-gx	160	16.0	17.0	18.0	-13.40	116	15.6	18.7
	360	17.6	18.7	19.8	-14.82	151	17.1	20.5
BXRE-xxx04Fx-B-gx	320	8.0	8.5	9.0	-13.40	116	7.8	9.3
	720	8.8	9.4	9.9	-14.82	151	8.6	10.3
BXRE-xxx04Fx-C-gx	80	31.9	33.9	35.9	-13.40	116	31.1	37.2
	180	35.1	37.3	39.5	-14.82	151	34.2	40.9

Notes for Table 5:

1. Parts are tested in pulsed conditions,  $T_c = 25^\circ\text{C}$ . Pulse width is 10ms.
2. Voltage minimum and maximum are provided for reference only and are not a guarantee of performance.
3. Bridgelux maintains a tester tolerance of  $\pm 0.10\text{V}$  on forward voltage measurements.
4. Typical coefficient of forward voltage tolerance is  $\pm 0.1\text{mV}$  for nominal current.
5. Thermal resistance values are based from test data of a 3000K 80 CRI product.
6. Thermal resistance value was calculated using total electrical input power; optical power was not subtracted from input power. The thermal interface material used during testing is not included in the thermal resistance value.
7.  $V_f$  min hot and max cold values are provided as reference only and are not guaranteed by test. These values are provided to aid in driver design and selection over the operating range of the product.
8. This product has been designed and manufactured per IEC 62031:2018.

# Eye Safety

**Table 6:** Eye Safety Risk Group (RG) Classifications

Part Number	Drive Current (mA)	CCT <sup>4</sup>	
		2700K/3000K	3500-5000K <sup>2,3</sup>
BXRE-xxx04Fx-A-gx		RG1	RG1
		RG1	RG2
BXRE-xxx04Fx-B-gx		RG1	RG1
		RG1	RG2
BXRE-xxx04Fx-C-gx		RG1	RG1
		RG1	RG2

Notes for Table 6:

1. Eye safety classification for the use of Bridgelux V Series LED arrays is in accordance with specification IEC/TR 62778: Application of IEC 62471 for the assessment of blue light hazard to light sources and luminaires.
2. For products classified as RG2 at 4000K, Ethr= 1980 lx.
3. For products classified as RG2 at 5000K Ethr= 1530 lx.
4. Please contact your Bridgelux sales representative for Ethr values at specific drive currents and CCTs not listed.

# Absolute Maximum Ratings

**Table 7:** Maximum Ratings

Parameter	Maximum Rating		
LED Junction Temperature (T <sub>j</sub> )	150°C		
Storage Temperature <sup>1</sup>	-40°C to +95°C		
Operating Case Temperature <sup>2</sup> (T <sub>c</sub> )	95°C		
Soldering Temperature <sup>3</sup>	300°C or lower for a maximum of 6 seconds		
	BXRE-xxx04Fx-A-gx	BXRE-xxx04Fx-B-gx	BXRE-xxx04Fx-C-gx
Maximum Drive Current <sup>4</sup>	360 mA at ≤85°C 270 mA at 95°C	720 mA at ≤85°C 540 mA at 95°C	180 mA at ≤85°C 135 mA at 95°C
Maximum Peak Pulsed Drive Current <sup>5</sup>	510 mA	1030 mA	250 mA
Maximum Reverse Voltage <sup>6</sup>	-30V	-15V	-60V

Notes for Table 7:

1. The Gen 9 product is robust enough to pass our internal humidity test but it is still more sensitive compared to regular LED array product. The product needs to be stored in a dry environment. It is not recommended to use the product in a damp environment that directly exposes it to moisture.
2. For IEC 62717 requirement, please consult your Bridgelux sales representative.
3. Refer to Bridgelux Application Note AN101: Handling and Assembly of Bridgelux V Series LED Arrays
4. Arrays may be driven at higher currents however lumen maintenance may be reduced and warranty will not apply.
5. Bridgelux recommends a maximum duty cycle of 10% and pulse width of 20 ms when operating LED Arrays at maximum peak pulsed current specified. Maximum peak pulsed currents indicate values where LED Arrays can be driven without catastrophic failures.
6. Light emitting diodes are not designed to be driven in reverse voltage and will not produce light under this condition. Maximum rating provided for reference only.

# Performance Curves

**Figure 1: V6A Drive Current vs. Voltage**

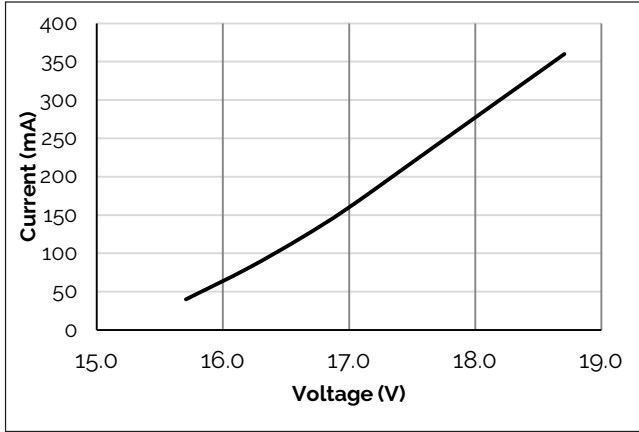

**Figure 2: V6B Drive Current vs. Voltage**

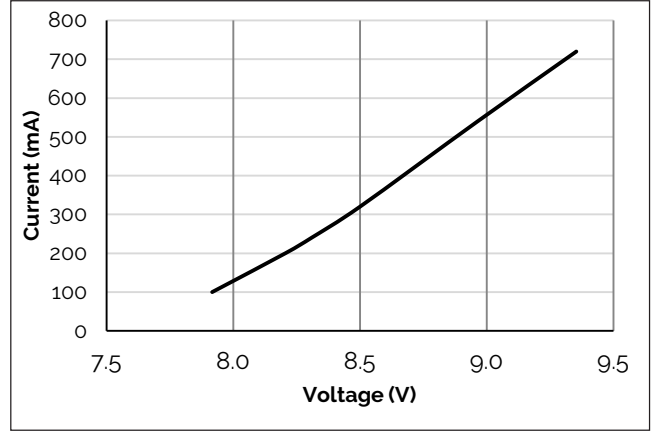

**Figure 3: V6C Drive Current vs. Voltage**

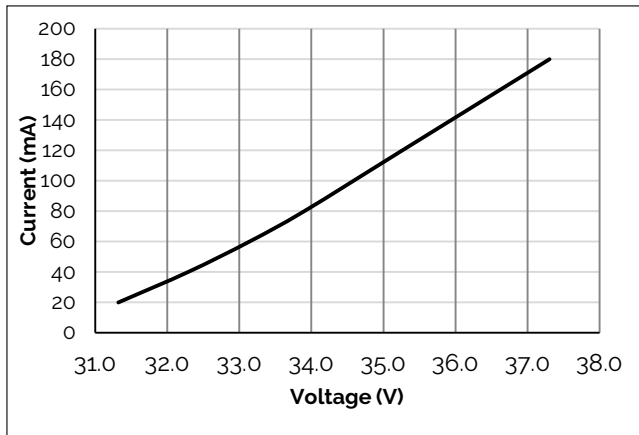

**Figure 4: V6A Typical Relative Flux vs. Current**

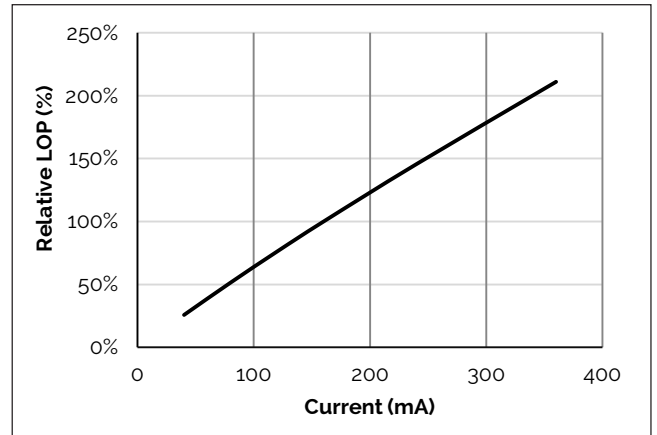

**Figure 5: V6B Typical Relative Flux vs. Current**

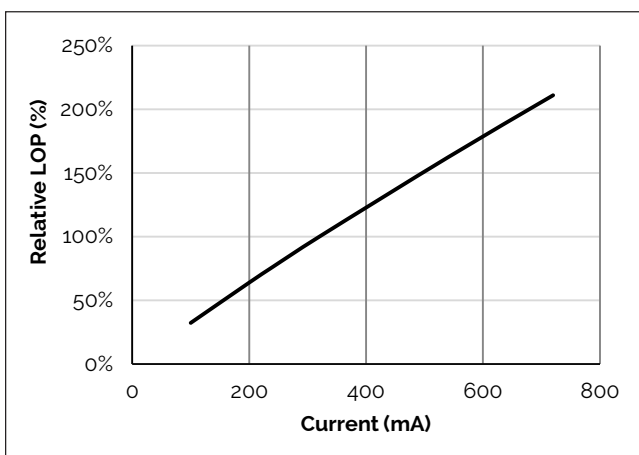

**Figure 6: V6C Typical Relative Flux vs. Current**

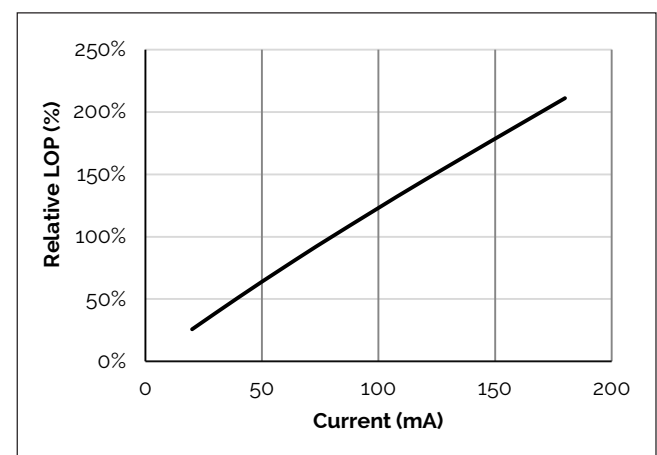

Notes for Figures 1-6:

1. Bridgelux does not recommend driving high power LEDs at low currents. Doing so may produce unpredictable results. Pulse width modulation (PWM) is recommended for dimming effects.
2. Products tested under pulsed condition (10ms pulse width) at nominal drive current where  $T_j$  (junction temperature) =  $T_c$  (case temperature) = 25°C.

# Performance Curves

**Figure 7: Typical DC Flux vs. Case Temperature**

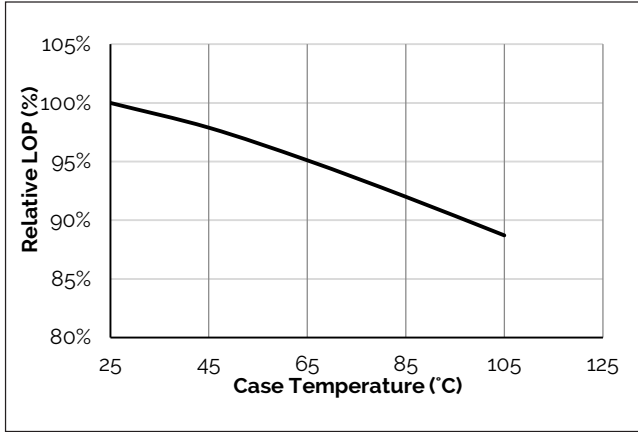

**Figure 8: Typical DC ccx Shift vs. Case Temperature**

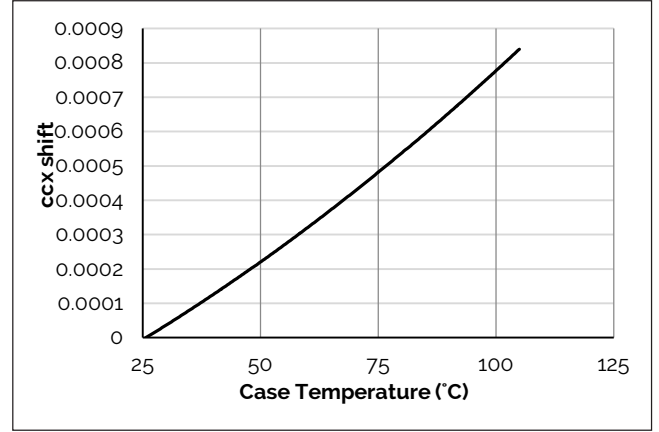

**Figure 9: Typical DC ccy Shift vs. Case Temperature**

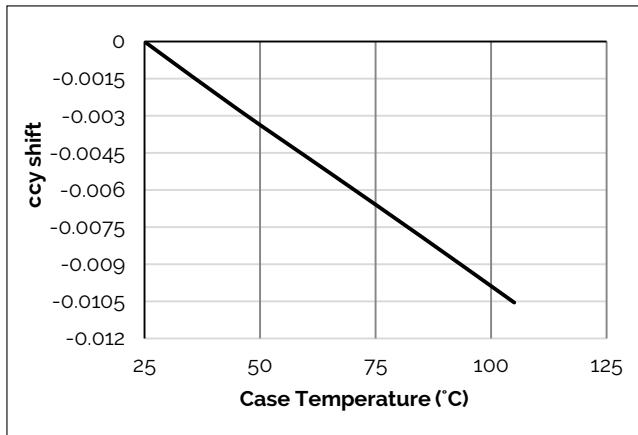

**Figure 10: V6A Drive Current vs. ccx Shift**

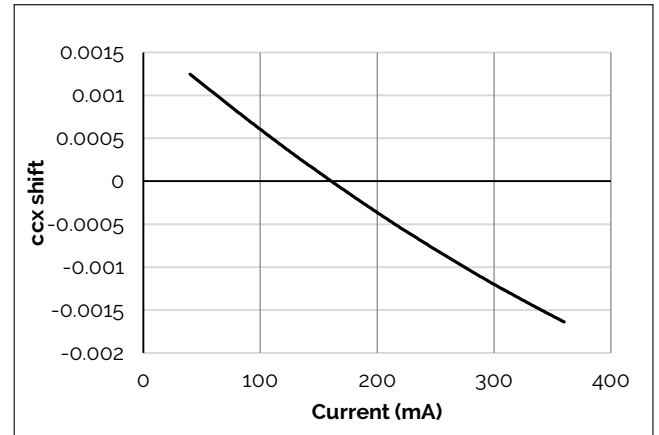

**Figure 11: V6A Drive Current vs. ccy Shift**

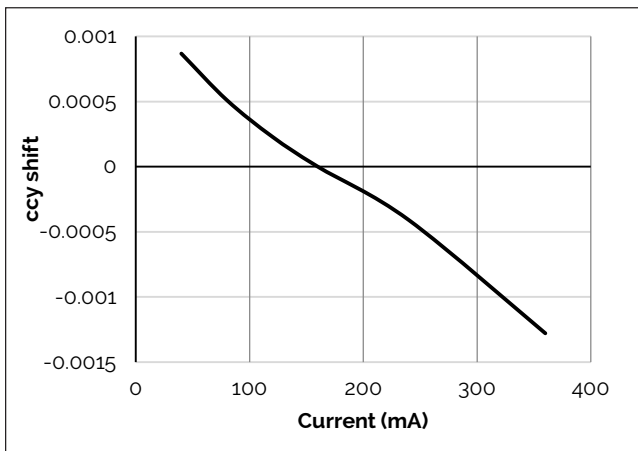

**Figure 12: V6B Drive Current vs. ccx Shift**

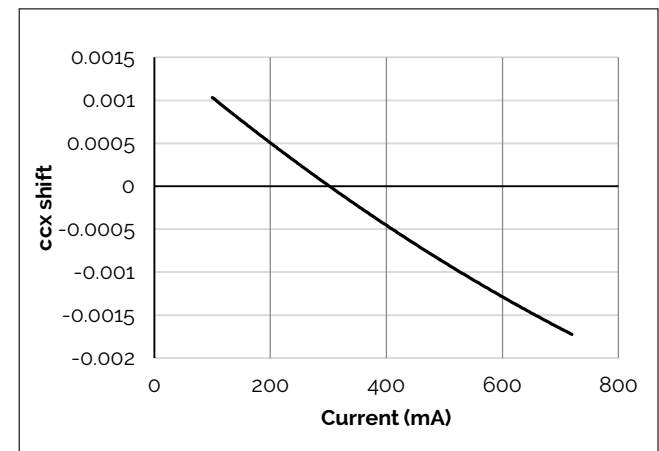

Note for Figures 7-12:

1. Characteristics shown for Warm White.

# Performance Curves

**Figure 13: V6B Drive Current vs. ccy Shift**

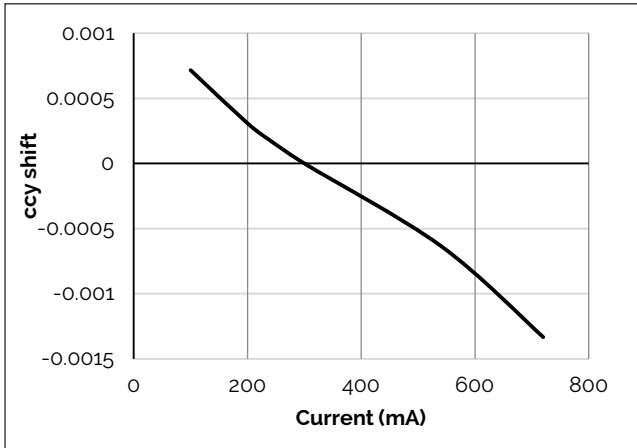

**Figure 14: V6C Drive Current vs. ccx Shift**

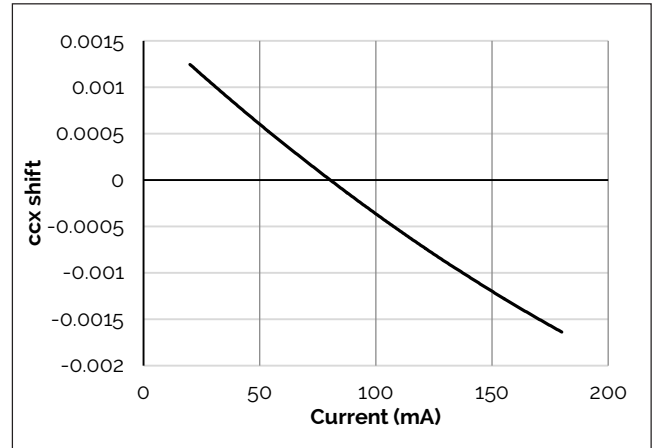

**Figure 15: V6C Drive Current vs. ccy Shift**

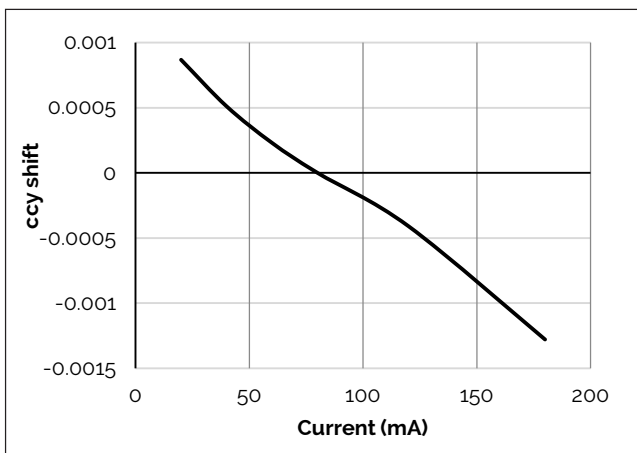

**Figure 16: Derating Curve**

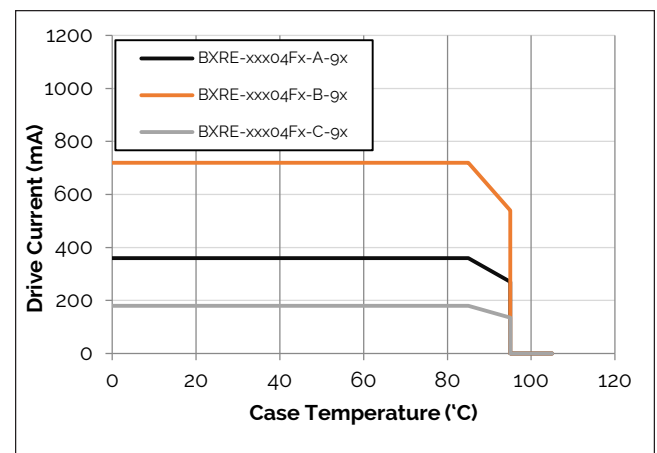

Note for Figures 13-15:

1. Characteristics shown for Warm White.



# Typical Radiation Pattern

Figure 17: Typical Spatial Radiation Pattern

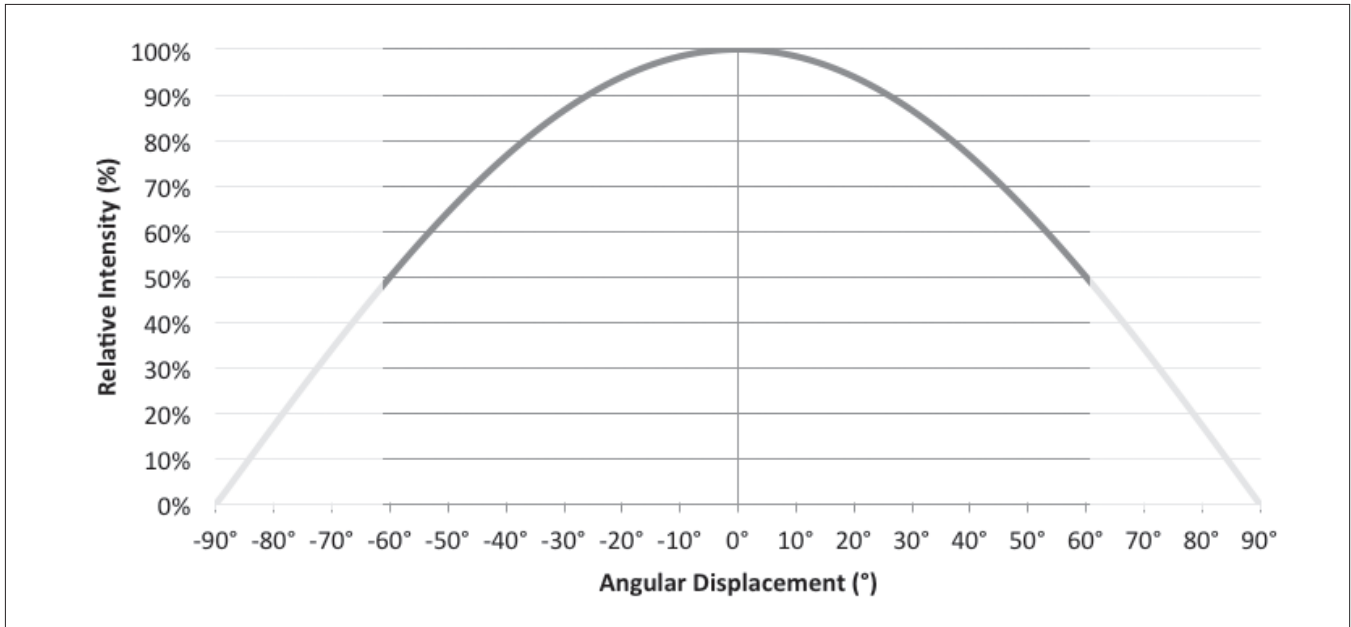

Notes for Figure 17:

1. Typical viewing angle is 120°.
2. The viewing angle is defined as the off axis angle from the centerline where intensity is ½ of the peak value.

Figure 18: Typical Polar Radiation Pattern

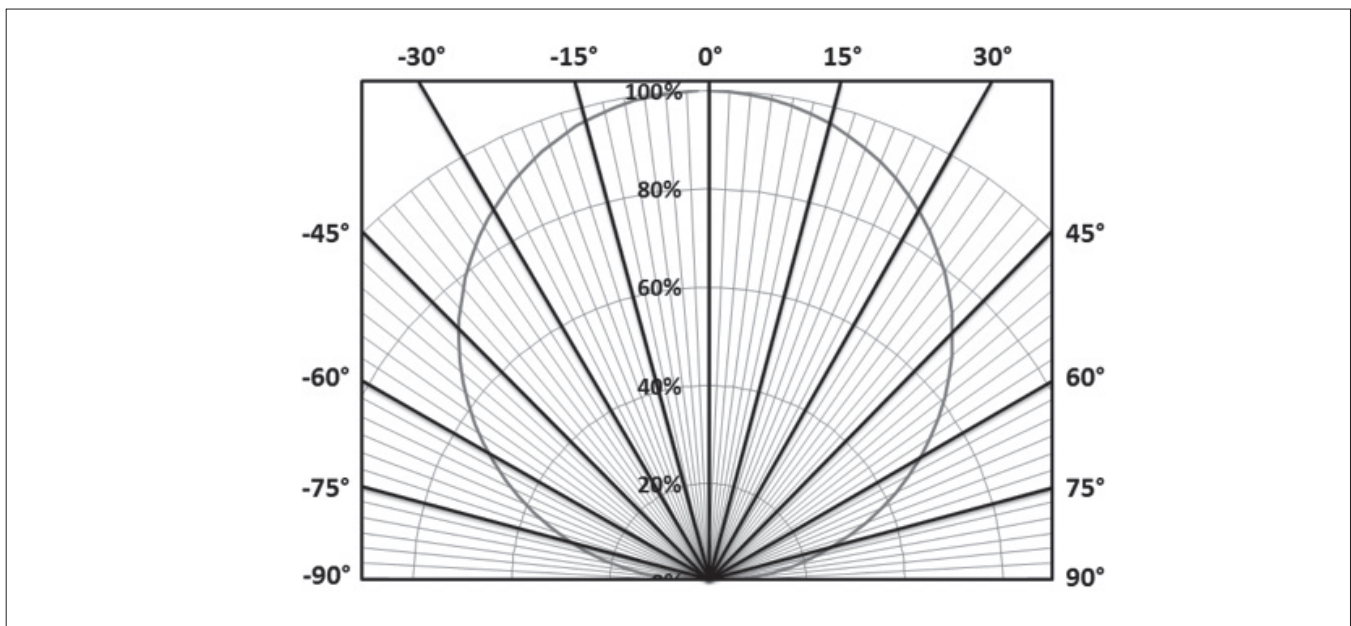

# Typical Color Spectrum

Figure 19: Typical Color Spectrum

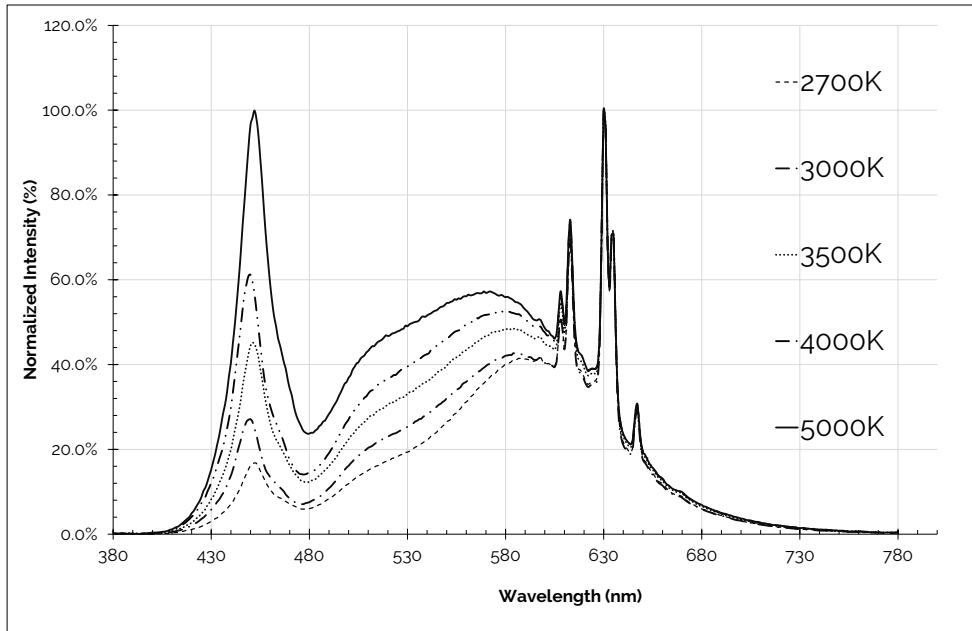

Notes for Figure 19:

1. Color spectra measured at nominal current for  $T_j = T_c = 85^\circ\text{C}$ .
2. Color spectra shown is 2700K and 80CRI.
3. Color spectra shown is 3000K and 80 CRI.
4. Color spectra shown is 3500K and 80 CRI.
5. Color spectra shown is 4000K and 80 CRI.
6. Color spectra shown is 5000K and 80 CRI.

# Mechanical Dimensions

Figure 20: Drawing for V6 LED Array

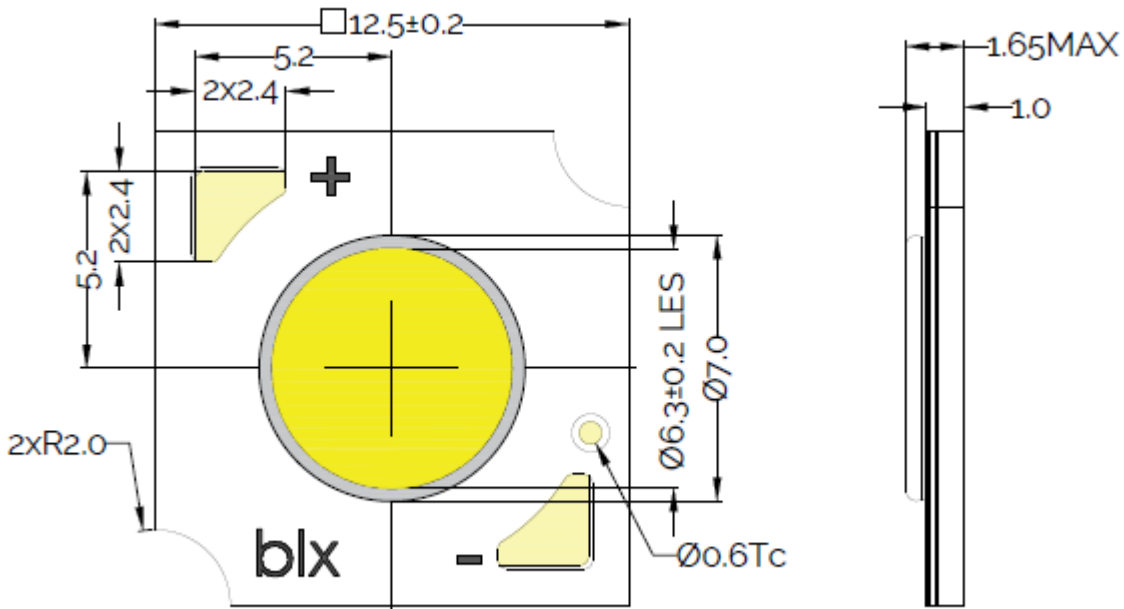

Notes for Figure 20:

1. Drawings are not to scale.
2. Drawing dimensions are in millimeters.
3. Solder pads are labeled "+" and "-" to denote positive and negative polarity, respectively.
4. Unless otherwise specified, tolerances are  $\pm 0.1$ mm.
5. Refer to Application Notes AN101 for product handling, mounting and heat sink recommendations.
6. The optical center of the LED Array is nominally defined by the mechanical center of the array to a tolerance of  $\pm 0.2$ mm.
7. Bridgelux maintains a flatness of  $0.10$ mm across the mounting surface of the array.

# Color Binning Information

**Figure 21: Warm, Neutral and Cool White Test Bins in xy Color Space**

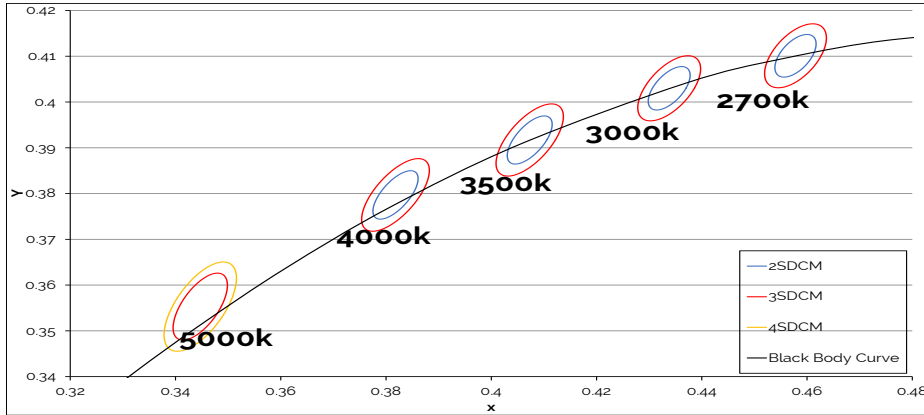

Note: Pulsed Test Conditions,  $T_c = 85^\circ\text{C}$

**Table 8:** Warm and Neutral White xy Bin Coordinates and Associated Typical CCT (product is hot targeted to  $T_c = 85^\circ\text{C}$ )

Bin Code	2700K	3000K	3500K	4000K
ANSI Bin (for reference only)	(2580K - 2870K)	(2870K - 3220K)	(3220K - 3710K)	(3710K - 4260K)
g3 (3 SDCM)	(2651K - 2794K)	(2968K - 3136K)	(3369K - 3586K)	(3851K - 4130K)
g2 (2 SDCM)	(2674K - 2769K)	(2995K - 3107K)	(3404K - 3548K)	(3895K - 4081K)
Center Point (x,y)	(0.4578, 0.4101)	(0.4338, 0.403)	(0.4073, 0.3917)	(0.3818, 0.3797)

**Table 9:** Cool White xy Bin Coordinates and Associated Typical CCT (product is hot targeted to  $T_c = 85^\circ\text{C}$ )

Bin Code	5000K
ANSI Bin (for reference only)	(4745K - 5311K)
g4 (4 SDCM)	(4801K - 5282K)
g3 (3 SDCM)	(4835K - 5215K)
Center Point (x,y)	(0.3447, 0.3553)

Note for Tables 8-g:

1. Bridgelux maintains a tolerance of +/- 0.007 on x and y color coordinates in the CIE 1931 color Space.

# Packaging and Labeling

Figure 22: V6 Packaging Tubes



Notes for Figure 22:

1. Each tube holds 40 V6 COB arrays.
2. One tube is sealed in an anti-static bag. Four bags are placed in a shipping box. Depending on quantities ordered, a bigger shipping box, containing four boxes may be used to ship products.
3. Each bag and box is to be labeled as shown above.
4. Dimensions for each tube are 21.3 (W) x 9.5(H) x 505 (L). Dimensions for the anti-static bag are 75 (W) x 615 (L) x 3.1 (T) mm. Dimensions for the shipping box are 58.7 x 13.3 x 7.9 cm.

# Packaging and Labeling

**Figure 23: Gen. 9 Product Labeling**

Bridgelux COB arrays have laser markings on the back side of the substrate to help with product identification. In addition to the product identification markings, Bridgelux COB arrays also contain markings for internal Bridgelux manufacturing use only. The image below shows which markings are for customer use and which ones are for Bridgelux internal use only. The Bridgelux internal manufacturing markings are subject to change without notice, however these will not impact the form, function or performance of the COB array.

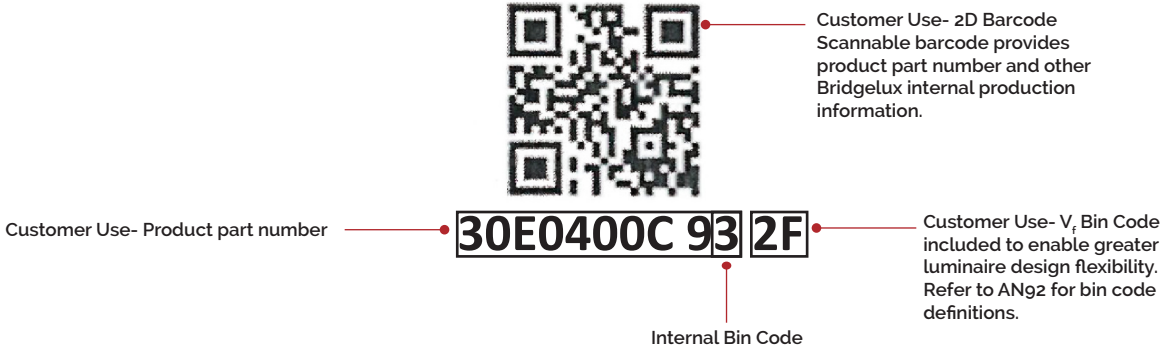

# Design Resources

## Application Notes

Bridgelux has developed a comprehensive set of application notes and design resources to assist customers in successfully designing with the V Series product family of LED array products. For all available application notes visit [www.bridgelux.com](http://www.bridgelux.com).

## Optical Source Models

Optical source models and ray set files are available for all Bridgelux products. For a list of available formats, visit [www.bridgelux.com](http://www.bridgelux.com).

## 3D CAD Models

Three dimensional CAD models depicting the product outline of all Bridgelux V Series LED arrays are available in both IGS and STEP formats. Please contact your Bridgelux sales representative for assistance.

## LM80

LM80 testing has been completed and the LM80 report is now available. Please contact your Bridgelux sales representative for LM-80 report.

# Precautions

## CAUTION: CHEMICAL EXPOSURE HAZARD

Exposure to some chemicals commonly used in luminaire manufacturing and assembly can cause damage to the LED array. Please consult Bridgelux Application Note AN101 for additional information.

## CAUTION: RISK OF BURN

Do not touch the V Series LED array during operation. Allow the array to cool for a sufficient period of time before handling. The V Series LED array may reach elevated temperatures such that could burn skin when touched.

## CAUTION

### CONTACT WITH LIGHT EMITTING SURFACE (LES)

Avoid any contact with the LES. Do not touch the LES of the LED array or apply stress to the LES (yellow phosphor resin area). Contact may cause damage to the LED array.

Optics and reflectors must not be mounted in contact with the LES (yellow phosphor resin area).

# Disclaimers

## MINOR PRODUCT CHANGE POLICY

The rigorous qualification testing on products offered by Bridgelux provides performance assurance. Slight cosmetic changes that do not affect form, fit, or function may occur as Bridgelux continues product optimization.

## STANDARD TEST CONDITIONS

Unless otherwise stated, array testing is performed at the nominal drive current.

# About Bridgelux: Bridging Light and Life™

At Bridgelux, we help companies, industries and people experience the power and possibility of light. Since 2002, we've designed LED solutions that are high performing, energy efficient, cost effective and easy to integrate. Our focus is on light's impact on human behavior, delivering products that create better environments, experiences and returns—both experiential and financial. And our patented technology drives new platforms for commercial and industrial luminaires.

**For more information about the company, please visit**  
**[bridgelux.com](http://bridgelux.com)**  
**[twitter.com/Bridgelux](https://twitter.com/Bridgelux)**  
**[facebook.com/Bridgelux](https://facebook.com/Bridgelux)**  
**[youtube.com/user/Bridgelux](https://youtube.com/user/Bridgelux)**  
**[linkedin.com/company/bridgelux-inc-\\_2](https://linkedin.com/company/bridgelux-inc-_2)**  
**WeChat ID: BridgeluxInChina**



46410 Fremont Boulevard  
Fremont, CA 94538 U.S.A.  
Tel (925) 583-8400  
**[www.bridgelux.com](http://www.bridgelux.com)**

© 2023 Bridgelux, Inc. All rights reserved. Product specifications are subject to change without notice. Bridgelux, the Bridgelux stylized logo design and Vero are registered trademarks. V Series and Decor Series are trademarks of Bridgelux, Inc. All other trademarks are the property of their respective owners.

Bridgelux GENg V6 Array Series Product Data Sheet DS1307 Rev. A (05/2023)