

THIS IS A C.A.D. GENERATED DRAWING
DO NOT MAKE MANUAL REVISIONS TO MASTER.

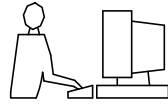

* UNLESS OTHERWISE SPECIFIED TOLERANCES
ON DECIMAL IS:

DRAWING UPDATED ③
Johnny DEC.04-2020
DRAWING UPDATED ④
Johnny March.15-2022

BACKSHELL KIT INCLUDES:

- (2)BACKSHELL HALVES
- (2)4-40 THUMBSCREWS
- (2)HOUSING SCREWS & (2)NUTS
- (1)SET OF COMPRESSION INSERTS-VARIOUS SIZES
DIAMETERS:4mm(.157"),5mm(.197"),7mm(.276"),9mm(.351")

NOTE: 37 POSITION HAS (4) HOUSING
SCREWS & (4)NUTS

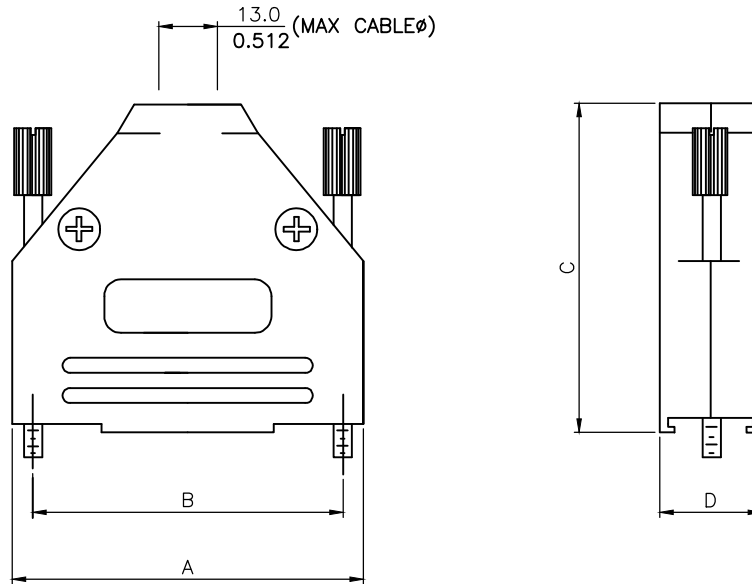

DIMENSIONS(mm/in)								
SIZE	A		B		C		D	
	MM	(±0.50)	MM	(±0.50)	MM	(±0.50)	MM	(±0.50)
	INCH	(±0.02)	INCH	(±0.02)	INCH	(±0.02)	INCH	(±0.02)
9	MM	31.50	MM	24.99	MM	40.50	MM	15.00
	INCH	1.240	INCH	0.984	INCH	1.594	INCH	0.591
15	MM	40.00	MM	33.32	MM	40.50	MM	15.00
	INCH	1.575	INCH	1.312	INCH	1.594	INCH	0.591
25	MM	54.00	MM	47.04	MM	49.50	MM	15.00
	INCH	2.126	INCH	1.852	INCH	1.949	INCH	0.591
37	MM	70.50	MM	63.50	MM	54.50	MM	16.00
	INCH	2.776	INCH	2.500	INCH	2.146	INCH	0.630

ORDERING INFORMATON:

SIZE	P/N - KITTED	PRODUCT CODE
9-WAY	6560-0145-01	MHDTPK-9-K
15-WAY	6560-0145-02	MHDTPK-15-K
25-WAY	6560-0145-03	MHDTPK-25-K
37-WAY	6560-0145-04	MHDTPK-37-K

SIZE	P/N - BULK	PRODUCT CODE
9-WAY	6561-0145-01	MHDTPK-9
15-WAY	6561-0145-02	MHDTPK-15
25-WAY	6561-0145-03	MHDTPK-25
37-WAY	6561-0145-04	MHDTPK-37

- PLASTIC: ABS UL 94-HB RATED
- PLATING: NICKEL PLATED
- JACKSCREWS: STEEL-ZINC PLATED
- M3 HOODSCREWS: STEEL-ZINC PLATED
- COMPRESSION INSERTS: ABS UL 94-HB RATED
- M3 NUTS: STEEL-ZINC PLATED
- OPERATING TEMP: -55°C TO+110°C

THESE DRAWINGS AND SPECIFICATIONS ARE THE
PROPERTY OF MH CONNECTORS AND SHALL NOT BE
REPRODUCED, COPIED OR USED AS THE BASIS FOR
THE MANUFACTURE OR SALE OF APPARATUS WITHOUT
WRITTEN PERMISSION.

DRAWN
Johnny
DATE
03-15-22

APPROVED
Victor Lin
DATE
03-15-22

SCALE SHEET OF REV:
1 OF 2 4.0

DRAWING No
MHDTPK SERIES



THIS SERIES FULLY CONFORMS TO THE
EUROPEAN UNION DIRECTIVES 2002/95/EC
AND 2002/96/EC FOR RoHS COMPLIANCY.



**MH CONNECTORS ,
DIVISION OF EDAC**

THIS IS A C.A.D. GENERATED DRAWING
DO NOT MAKE MANUAL REVISIONS TO MASTER.

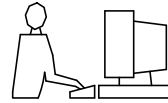

* UNLESS OTHERWISE SPECIFIED TOLERANCES
ON DECIMAL IS:

DRAWING UPDATED	③
Johnny	DEC.04-2020
DRAWING UPDATED	④
Johnny	March.15-2022

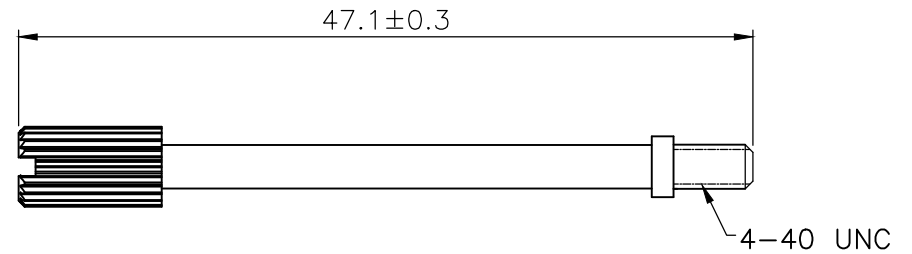
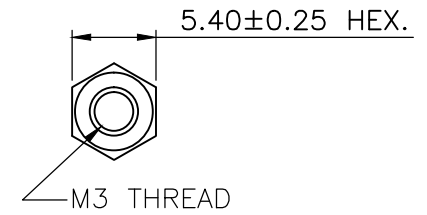
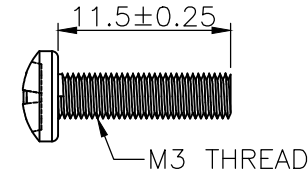
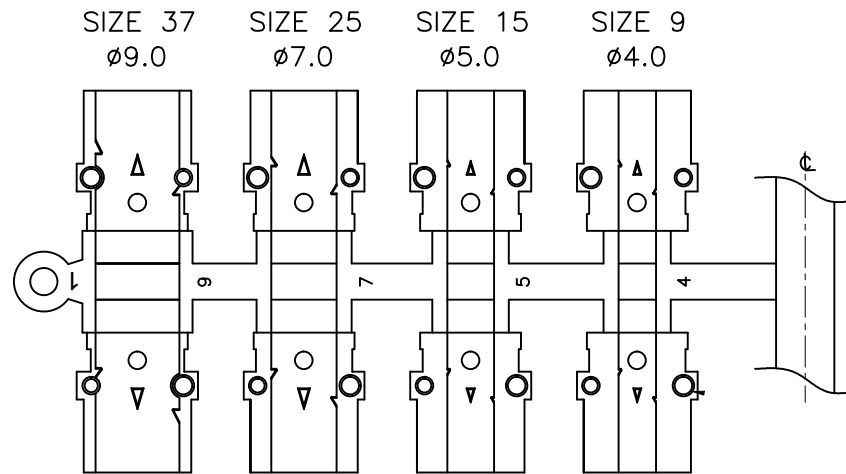

THESE DRAWINGS AND SPECIFICATIONS ARE THE PROPERTY OF MH CONNECTORS AND SHALL NOT BE REPRODUCED, COPIED OR USED AS THE BASIS FOR THE MANUFACTURE OR SALE OF APPARATUS WITHOUT WRITTEN PERMISSION.

DRAWN	DATE
Johnny	03-15-22

APPROVED	DATE
Victor Lin	03-15-22

SCALE	SHEET OF	REV:
	2 OF 2	4.0

DRAWING No
MHDPK SERIES



THIS SERIES FULLY CONFORMS TO THE EUROPEAN UNION DIRECTIVES 2002/95/EC AND 2002/96/EC FOR RoHS COMPLIANCY.



**MH CONNECTORS ,
DIVISION OF EDAC**

THIS IS A C.A.D. GENERATED DRAWING
DO NOT MAKE MANUAL REVISIONS TO MASTER.

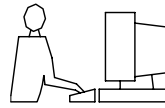

* UNLESS OTHERWISE SPECIFIED TOLERANCES
ON DECIMAL IS: .XX ± 0.35

UNIT: MM

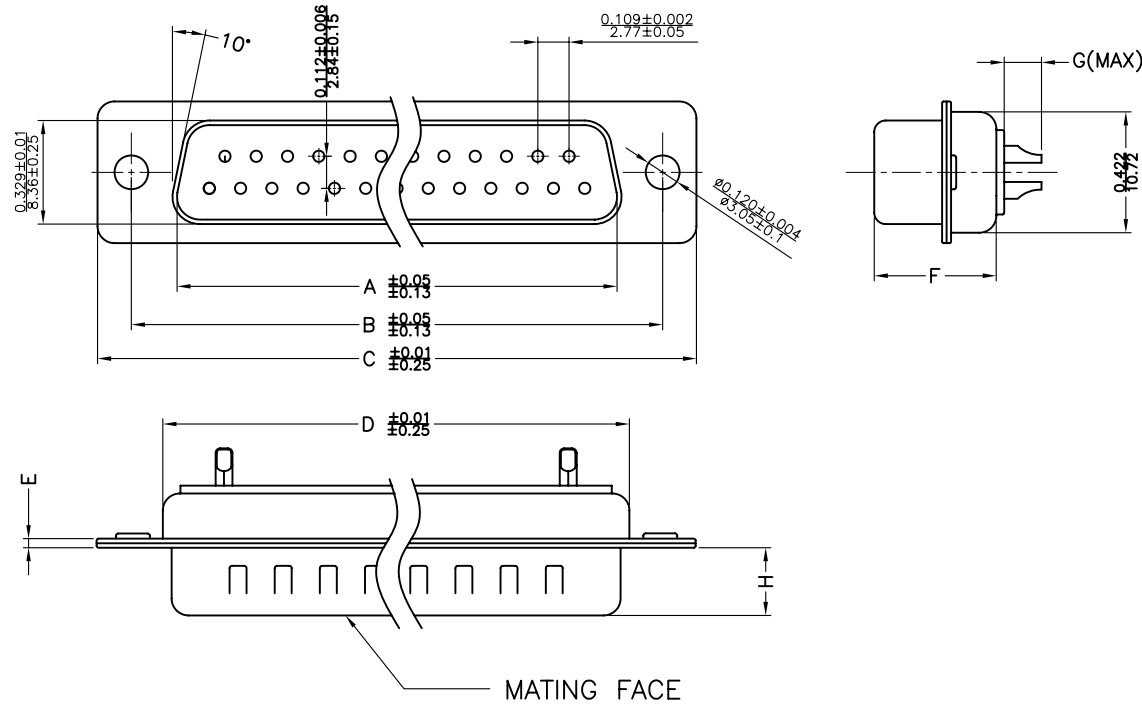

Material & Finish

Shell:
Steel
Nickel or Tin plated

Pin Contact:

Brass
Gold plated over nickel

Insulator:

PBT glass-fiber reinforced UL 94-V0

Number of contact:

9,15,25,37,50

Current rating: 5 amp

Dielectric strength:

1000V for one minute

Insulator resistance:

1000MΩ Min at 500V DC

Temperature: -55°C ~ 105°C

ITEM NO	A	B	C	D	E	F	G	H
MHDM9SP	16.92(0.666)	24.99(0.984)	30.81(1.213)	19.23(0.757)	1.0(0.0394)	10.8(0.425)	2.7(0.106)	5.84(0.23)
MHDM15SP	25.25(0.994)	33.32(1.312)	39.14(1.541)	27.56(1.085)	1.0(0.0394)	10.8(0.425)	2.7(0.106)	5.84(0.23)
MHDM25SP	38.96(1.534)	47.04(1.852)	53.04(2.088)	41.30(1.625)	1.0(0.0394)	10.8(0.425)	2.7(0.106)	5.84(0.23)
MHDM37SP	55.42(2.182)	63.50(2.500)	69.32(2.729)	57.71(2.272)	1.0(0.0394)	10.8(0.425)	2.7(0.106)	5.84(0.23)
MHDM50SP	52.86(2.081)	61.11(2.406)	66.92(2.634)	55.30(2.177)	1.0(0.0394)	10.8(0.425)	2.7(0.106)	5.84(0.23)

THESE DRAWINGS AND SPECIFICATIONS ARE THE PROPERTY OF MH CONNECTORS LTD. AND SHALL NOT BE REPRODUCED, COPIED OR USED AS THE BASIS FOR THE MANUFACTURE OR SALE OF APPARATUS WITHOUT WRITTEN PERMISSION.

DRAWN Johnny	DATE 07-24-12
APPROVED	DATE

SCALE 1:1	SHEET OF 1 OF 1	REV: 1.0
--------------	--------------------	-------------

DRAWING No
MHDM SP



THIS SERIES FULLY CONFORMS TO THE EUROPEAN UNION DIRECTIVES 2002/95/EC AND 2002/96/EC FOR RoHS COMPLIANCY.



MH CONNECTORS LTD.