

N-channel 600 V, 370 mΩ typ., 10 A MDmesh DM2 Power MOSFET in a TO-220FP package

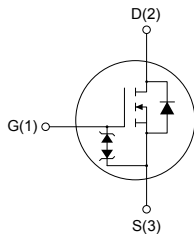

TO-220FP



NG1D2S3Z

Order code	$V_{DS} @ T_{Jmax}$	$R_{DS(on)max.}$	I_D	P_{TOT}
STF11N60DM2	650 V	420 mΩ	10 A	25 W

- Fast-recovery body diode
- Extremely low gate charge and input capacitance
- Low on-resistance
- 100% avalanche tested
- Extremely high dv/dt ruggedness
- Zener-protected

Applications

- Switching applications

Description

This high-voltage N-channel Power MOSFET is part of the MDmesh DM2 fast-recovery diode series. It offers very low recovery charge (Q_{rr}) and time (t_{rr}) combined with low $R_{DS(on)}$, rendering it suitable for the most demanding high-efficiency converters and ideal for bridge topologies and ZVS phase-shift converters.



Product status

STF11N60DM2

Product summary

Order code	STF11N60DM2
Marking	11N60DM2
Package	TO220FP
Packing	Tube

1 Electrical ratings

Table 1. Absolute maximum ratings

Symbol	Parameter	Value	Unit
V_{GS}	Gate-source voltage	± 25	V
I_D	Drain current (continuous) at $T_{case} = 25\text{ °C}$	10	A
	Drain current (continuous) at $T_{case} = 100\text{ °C}$	6.3	
$I_{DM}^{(1)}$	Drain current (pulsed)	40	A
P_{TOT}	Total power dissipation at $T_{case} = 25\text{ °C}$	25	W
$dv/dt^{(2)}$	Peak diode recovery voltage slope	50	V/ns
$dv/dt^{(3)}$	MOSFET dv/dt ruggedness	50	
$V_{ISO}^{(4)}$	Insulation withstand voltage (RMS) from all three leads to external heat sink	2.5	kV
T_{stg}	Storage temperature range	-55 to 150	°C
T_j	Operating junction temperature range		

1. Pulse width is limited by safe operating area.
2. $I_{SD} \leq 10\text{ A}$, $di/dt=900\text{ A}/\mu\text{s}$; $V_{DS\text{ peak}} < V_{(BR)DSS}$; $V_{DD} = 400\text{ V}$
3. $V_{DS} \leq 480\text{ V}$.
4. $t = 1\text{ s}$; $T_C = 25\text{ °C}$

Table 2. Thermal data

Symbol	Parameter	Value	Unit
$R_{thj-case}$	Thermal resistance junction-case	5	°C/W
$R_{thj-amb}$	Thermal resistance junction-ambient	62.5	

Table 3. Avalanche characteristics

Symbol	Parameter	Value	Unit
$I_{AR}^{(1)}$	Avalanche current, repetitive or not repetitive	2.5	A
$E_{AS}^{(2)}$	Single pulse avalanche energy	250	mJ

1. pulse width limited by T_{jmax}
2. starting $T_j = 25\text{ °C}$, $I_D = I_{AR}$, $V_{DD} = 50\text{ V}$.

2 Electrical characteristics

($T_{\text{case}} = 25\text{ }^{\circ}\text{C}$ unless otherwise specified)

Table 4. Static

Symbol	Parameter	Test conditions	Min.	Typ.	Max.	Unit
$V_{(\text{BR})\text{DSS}}$	Drain-source breakdown voltage	$V_{\text{GS}} = 0\text{ V}$, $I_{\text{D}} = 1\text{ mA}$	600			V
I_{DSS}	Zero gate voltage drain current	$V_{\text{GS}} = 0\text{ V}$, $V_{\text{DS}} = 600\text{ V}$			1.5	μA
		$V_{\text{GS}} = 0\text{ V}$, $V_{\text{DS}} = 600\text{ V}$, $T_{\text{case}} = 125\text{ }^{\circ}\text{C}^{(1)}$			100	
I_{GSS}	Gate-body leakage current	$V_{\text{DS}} = 0\text{ V}$, $V_{\text{GS}} = \pm 25\text{ V}$			± 5	μA
$V_{\text{GS(th)}}$	Gate threshold voltage	$V_{\text{DS}} = V_{\text{GS}}$, $I_{\text{D}} = 250\text{ }\mu\text{A}$	3	4	5	V
$R_{\text{DS(on)}}$	Static drain-source on-resistance	$V_{\text{GS}} = 10\text{ V}$, $I_{\text{D}} = 5\text{ A}$		370	420	m Ω

1. Defined by design, not subject to production test.

Table 5. Dynamic

Symbol	Parameter	Test conditions	Min.	Typ.	Max.	Unit
C_{iss}	Input capacitance	$V_{\text{DS}} = 100\text{ V}$, $f = 1\text{ MHz}$, $V_{\text{GS}} = 0\text{ V}$	-	614	-	μF
C_{oss}	Output capacitance		-	32	-	
C_{riss}	Reverse transfer capacitance		-	1.08	-	
$C_{\text{oss eq.}}^{(1)}$	Equivalent output capacitance	$V_{\text{DS}} = 0\text{ to }480\text{ V}$, $V_{\text{GS}} = 0\text{ V}$	-	57	-	μF
R_{G}	Intrinsic gate resistance	$f = 1\text{ MHz}$, $I_{\text{D}} = 0\text{ A}$	-	6.2	-	Ω
Q_{g}	Total gate charge	$V_{\text{DD}} = 480\text{ V}$, $I_{\text{D}} = 10\text{ A}$, $V_{\text{GS}} = 0\text{ to }10\text{ V}$ (see Figure 14. Test circuit for gate charge behavior)	-	16.5	-	nC
Q_{gs}	Gate-source charge		-	3.8	-	
Q_{gd}	Gate-drain charge		-	9.2	-	

1. $C_{\text{oss eq.}}$ is defined as a constant equivalent capacitance giving the same charging time as C_{oss} when V_{DS} increases from 0 to 80% V_{DSS} .

Table 6. Switching times

Symbol	Parameter	Test conditions	Min.	Typ.	Max.	Unit
$t_{\text{d(on)}}$	Turn-on delay time	$V_{\text{DD}} = 300\text{ V}$, $I_{\text{D}} = 5\text{ A}$, $R_{\text{G}} = 4.7\text{ }\Omega$, $V_{\text{GS}} = 10\text{ V}$ (see Figure 13. Test circuit for resistive load switching times and Figure 18. Switching time waveform)	-	11.7	-	ns
t_{r}	Rise time		-	6.3	-	
$t_{\text{d(off)}}$	Turn-off delay time		-	31	-	
t_{f}	Fall time		-	9.5	-	

Table 7. Source-drain diode

Symbol	Parameter	Test conditions	Min.	Typ.	Max.	Unit
$I_{SD}^{(1)}$	Source-drain current		-		10	A
$I_{SDM}^{(2)}$	Source-drain current (pulsed)		-		40	A
$V_{SD}^{(3)}$	Forward on voltage	$V_{GS} = 0\text{ V}$, $I_{SD} = 10\text{ A}$	-		1.6	V
t_{rr}	Reverse recovery time	$I_{SD} = 10\text{ A}$, $di/dt = 100\text{ A}/\mu\text{s}$, $V_{DD} = 60\text{ V}$ (see Figure 15. Test circuit for inductive load switching and diode recovery times)	-	90		ns
Q_{rr}	Reverse recovery charge		-	248		nC
I_{RRM}	Reverse recovery current		-	5.5		A
t_{rr}	Reverse recovery time	$I_{SD} = 10\text{ A}$, $di/dt = 100\text{ A}/\mu\text{s}$, $V_{DD} = 60\text{ V}$, $T_j = 150\text{ }^\circ\text{C}$ (see Figure 15. Test circuit for inductive load switching and diode recovery times)	-	160		ns
Q_{rr}	Reverse recovery charge		-	664		nC
I_{RRM}	Reverse recovery current		-	8.3		A

1. Limited by maximum junction temperature.
2. Pulse width is limited by safe operating area.
3. Pulse test: pulse duration = 300 μs , duty cycle 1.5%.

Table 8. Gate-source Zener diode

Symbol	Parameter	Test conditions	Min.	Typ.	Max.	Unit
$V_{(BR)GSO}$	Gate-source breakdown voltage	$I_{GS} = \pm 250\text{ }\mu\text{A}$, $I_D = 0\text{ A}$	± 30	-	-	V

The built-in back-to-back Zener diodes are specifically designed to enhance the ESD performance of the device. The Zener voltage facilitates efficient and cost-effective device integrity protection, thus eliminating the need for additional external componentry.

2.1 Electrical characteristics (curves)

Figure 1. Safe operating area

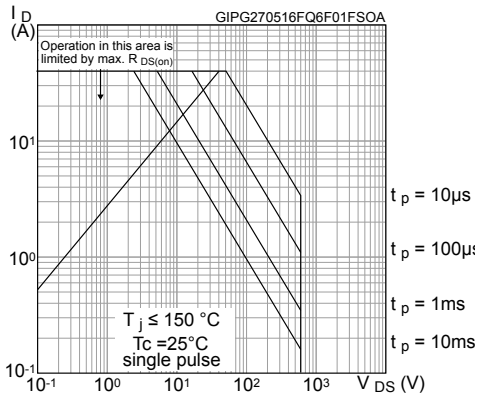

Figure 2. Thermal impedance

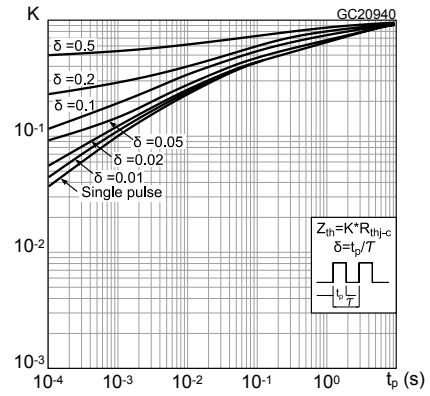

Figure 3. Output characteristics

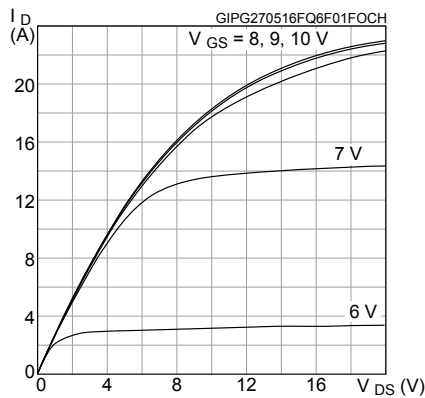

Figure 4. Transfer characteristics

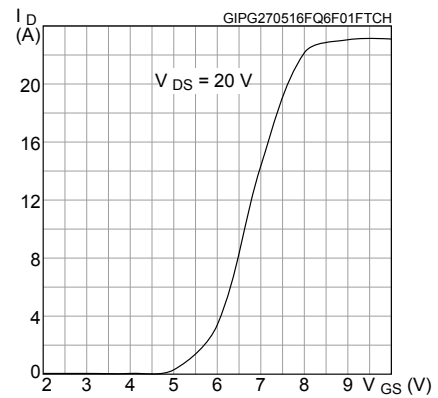

Figure 5. Gate charge vs gate-source voltage

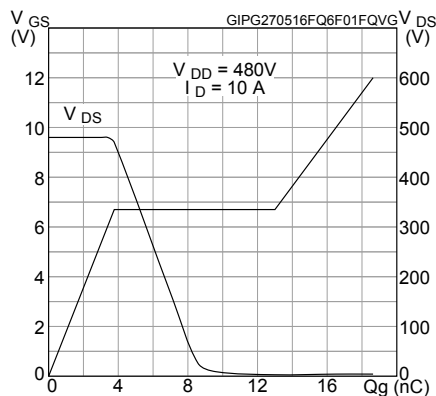

Figure 6. Static drain-source on-resistance

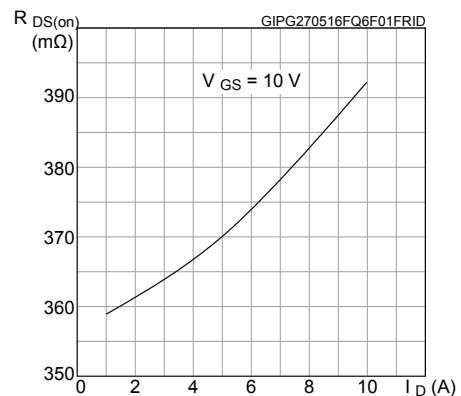

Figure 7. Capacitance variations

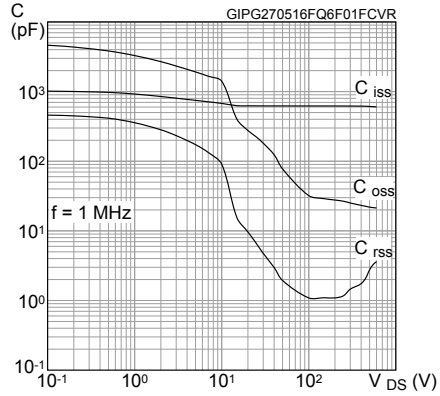

Figure 8. Normalized gate threshold voltage vs temperature

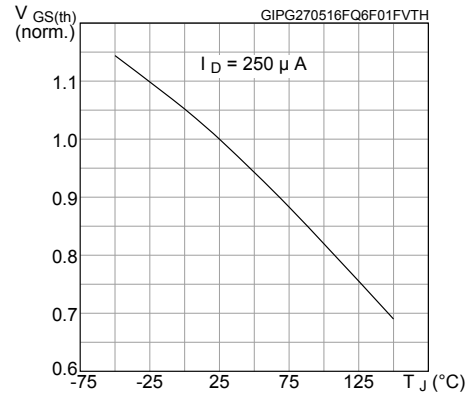

Figure 9. Normalized on-resistance vs temperature

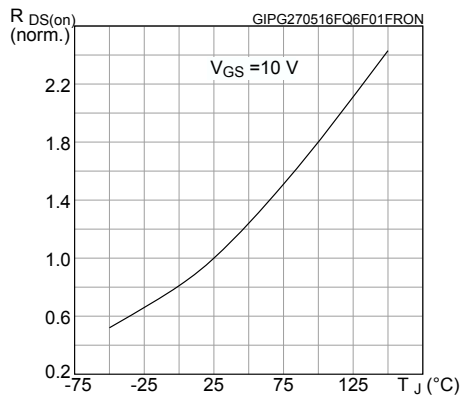

Figure 10. Normalized V_{(BR)DSS} vs temperature

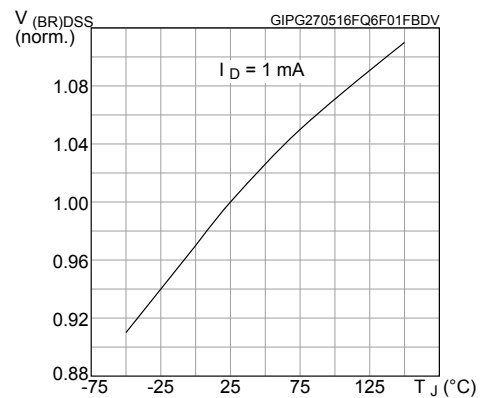

Figure 11. Output capacitance stored energy

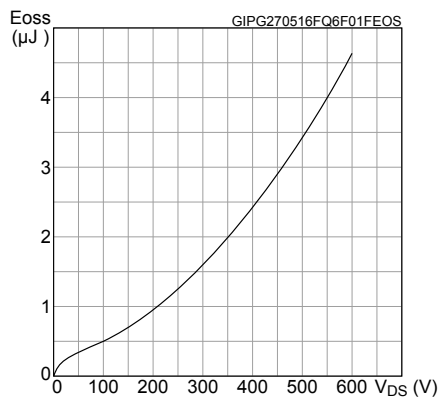
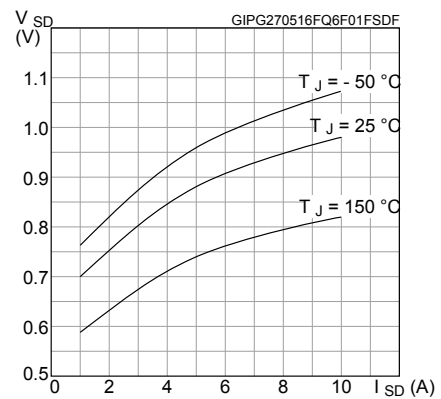

Figure 12. Source-drain diode forward characteristics



3 Test circuits

Figure 13. Test circuit for resistive load switching times

AM01468v1

Figure 14. Test circuit for gate charge behavior

AM01469v1

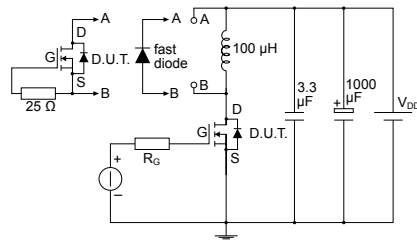
Figure 15. Test circuit for inductive load switching and diode recovery times

AM01470v1

Figure 16. Unclamped inductive load test circuit

AM01471v1

Figure 17. Unclamped inductive waveform

AM01472v1

Figure 18. Switching time waveform



AM01473v1

4 Package information

In order to meet environmental requirements, ST offers these devices in different grades of **ECOPACK** packages, depending on their level of environmental compliance. ECOPACK specifications, grade definitions and product status are available at: www.st.com. ECOPACK is an ST trademark.

4.1 TO-220FP package information

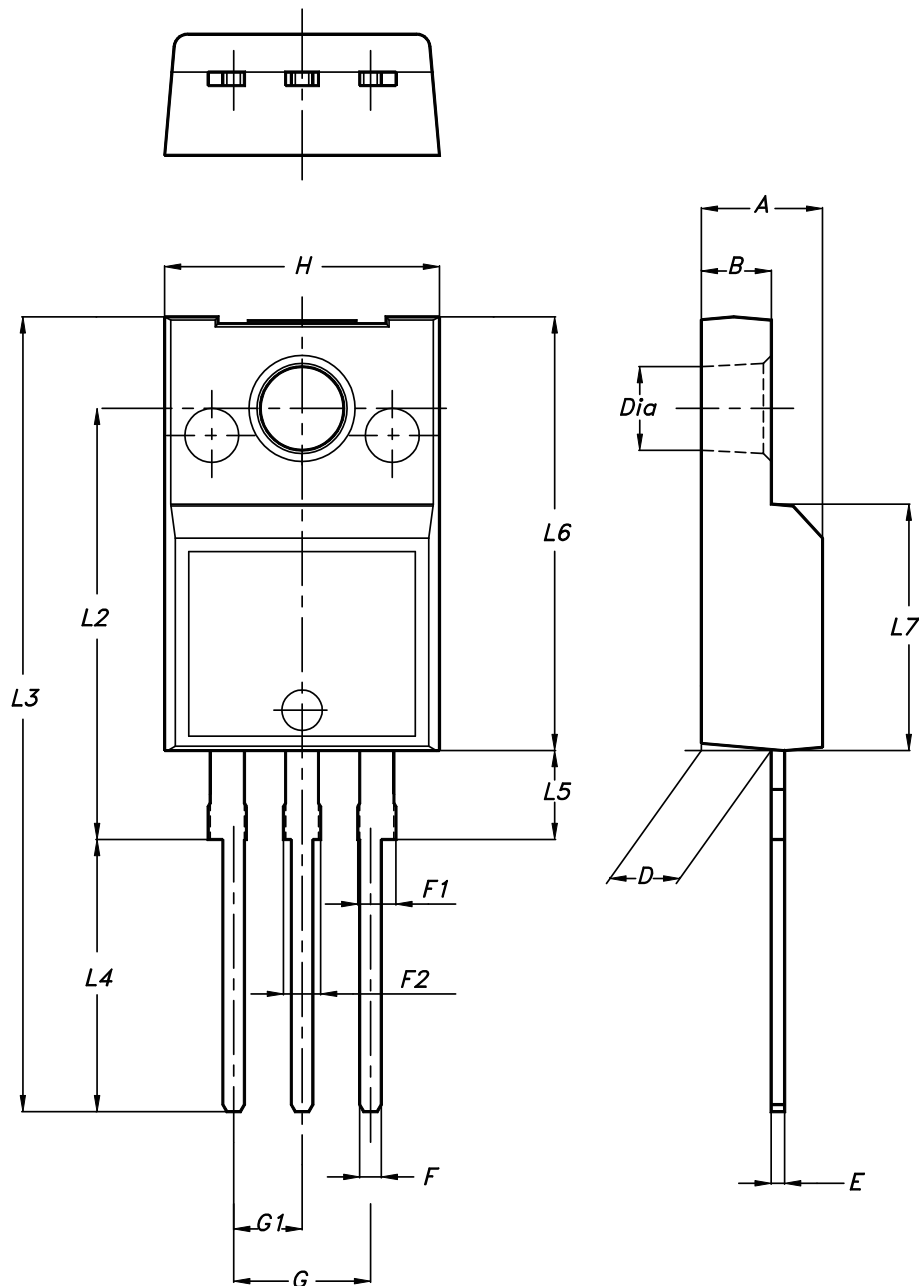
Figure 19. TO-220FP package outline



7012510_Rev_13_B

Table 9. TO-220FP package mechanical data

Dim.	mm		
	Min.	Typ.	Max.
A	4.40		4.60
B	2.50		2.70
D	2.50		2.75
E	0.45		0.70
F	0.75		1.00
F1	1.15		1.70
F2	1.15		1.70
G	4.95		5.20
G1	2.40		2.70
H	10.00		10.40
L2		16.00	
L3	28.60		30.60
L4	9.80		10.60
L5	2.90		3.60
L6	15.90		16.40
L7	9.00		9.30
Dia	3.00		3.20

Revision history

Table 10. Document revision history

Date	Revision	Changes
17-Jun-2016	1	First release.
04-Nov-2019	2	Modified Table 1. Absolute maximum ratings . Minor text changes.

Contents

1	Electrical ratings	2
2	Electrical characteristics	3
2.1	Electrical characteristics (curves)	5
3	Test circuits	7
4	Package information	8
4.1	TO-220FP package information	8
	Revision history	10

IMPORTANT NOTICE – PLEASE READ CAREFULLY

STMicroelectronics NV and its subsidiaries (“ST”) reserve the right to make changes, corrections, enhancements, modifications, and improvements to ST products and/or to this document at any time without notice. Purchasers should obtain the latest relevant information on ST products before placing orders. ST products are sold pursuant to ST’s terms and conditions of sale in place at the time of order acknowledgement.

Purchasers are solely responsible for the choice, selection, and use of ST products and ST assumes no liability for application assistance or the design of Purchasers’ products.

No license, express or implied, to any intellectual property right is granted by ST herein.

Resale of ST products with provisions different from the information set forth herein shall void any warranty granted by ST for such product.

ST and the ST logo are trademarks of ST. For additional information about ST trademarks, please refer to www.st.com/trademarks. All other product or service names are the property of their respective owners.

Information in this document supersedes and replaces information previously supplied in any prior versions of this document.

© 2019 STMicroelectronics – All rights reserved

Mouser Electronics

Authorized Distributor

Click to View Pricing, Inventory, Delivery & Lifecycle Information:

[STMicroelectronics:](#)

[STF11N60DM2](#)