

# Slim Relay G2RV

## The only truly industrial 6 mm relay

- Lockable test switch models now available.
- Large plug-in terminals for reliable connection.
- LED indicator and mechanical flag for status indication.
- Input type with gold plated contacts available.
- Transparent housing allows inspection of contact condition.
- Slim width to save space.
- Push-in terminals and accessories for easy wiring.
- Lloyd's approval

Test switch type

No test switch type

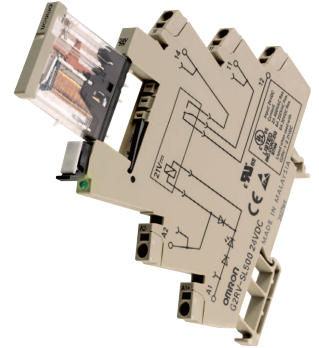
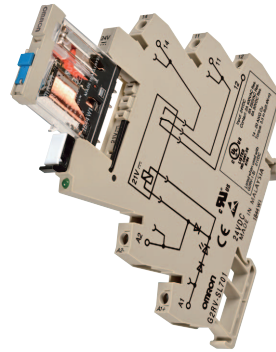

**PATENTED**

CE cUL US LISTED VDE LR

## Features

### ■ Test switch operation

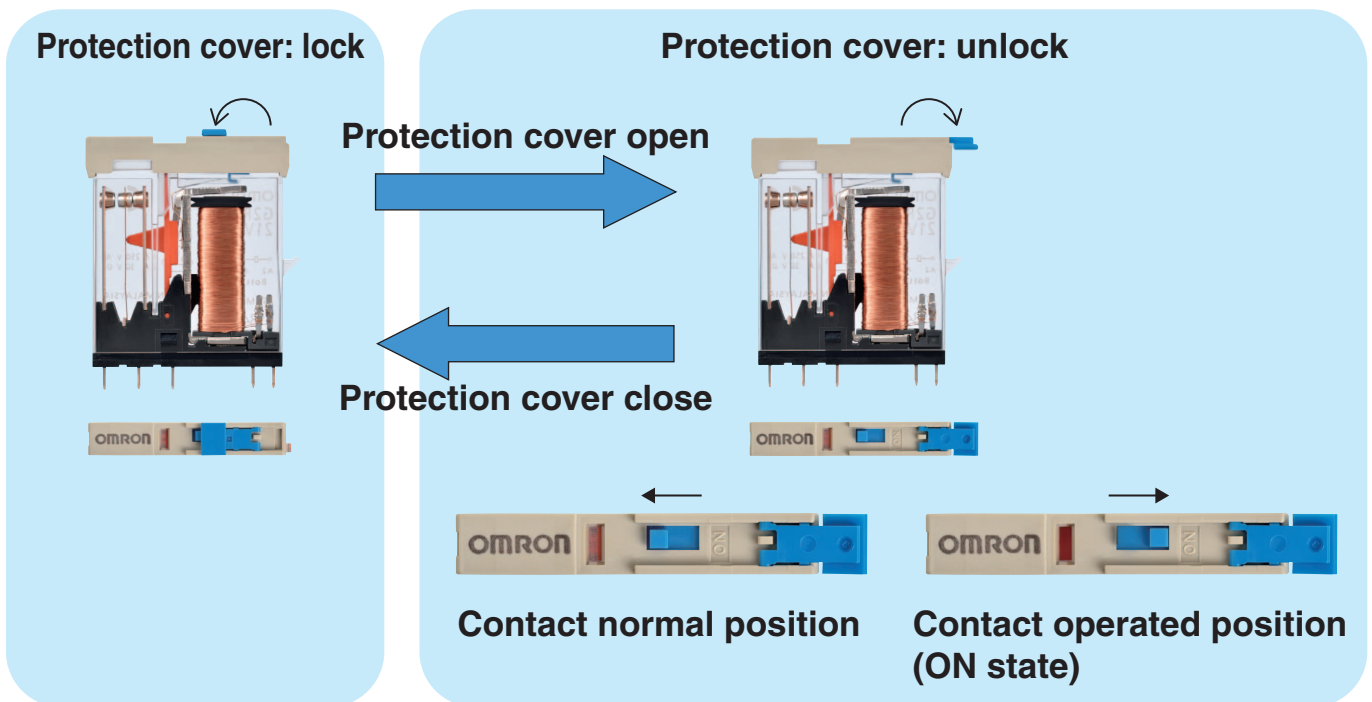

#### OMRON Lockable test switch can be used in this way:

When the protection cover (located directly over the test switch) is closed, the test switch is retained in normal position (OFF state) by the protection cover. After opening the protection cover, the test switch can be unlocked. The test switch can then be moved to the operated position (ON state). After using the test switch, move it to the normal position (OFF state) and close the protection cover to prevent unwanted operation of the test switch.

\* Please check Precautions (Page. 17 : Precaution of test switch operation) when using test switch.

#### Application of test switch:

Example: Checking operation of Relays and sequence circuits.

# Model Number Structure

## Model Number Legend

G2RV-SL    -  -   
 1 2 3 4 5 6

### 1. Auxiliary Type Designation

SL: Slim relay and socket combination

### 2. Wire Connection

7: Screw terminals

5: Push-in terminals

### 3. Relay LED

0: Without LED

### 4. Relay Test switch

0: No test switch type

1: Test switch type

### 5. Contact form

AP: Input type

Blank: Standard type

### 6. Input Voltage

**Note:** LED indicator available on socket.

## Ordering Information

### List of Models

Classification		Enclosure rating	Input voltage	Type of connection	Test switch	Contact form (SPDT)	
						Standard type	Input type
Plug-in terminals	General-purpose	Unsealed	AC/DC	Screw terminals	No	G2RV-SL700	G2RV-SL700-AP
					Yes	G2RV-SL701	---
				Push-in terminals	No	G2RV-SL500	G2RV-SL500-AP
					Yes	G2RV-SL501	---

### Relay and Socket Combinations

#### No test switch type

Input voltage	Contact form (SPDT)			
	Standard type (No test switch type)		Input type (No test switch type)	
	Screw terminals	Push-in terminals	Screw terminals	Push-in terminals
12 VDC	G2RV-SL700 12 VDC	G2RV-SL500 12 VDC	G2RV-SL700-AP 12 VDC	G2RV-SL500-AP 12 VDC
24 VDC	G2RV-SL700 24 VDC	G2RV-SL500 24 VDC	G2RV-SL700-AP 24 VDC	G2RV-SL500-AP 24 VDC
24 VAC/DC	G2RV-SL700 24 VAC/DC	G2RV-SL500 24 VAC/DC	G2RV-SL700-AP 24 VAC/DC	G2RV-SL500-AP 24 VAC/DC
48 VAC/DC	G2RV-SL700 48 VAC/DC	G2RV-SL500 48 VAC/DC	G2RV-SL700-AP 48 VAC/DC	G2RV-SL500-AP 48 VAC/DC
110 VAC	G2RV-SL700 110 VAC	G2RV-SL500 110 VAC	G2RV-SL700-AP 110 VAC	G2RV-SL500-AP 110 VAC
230 VAC	G2RV-SL700 230 VAC	G2RV-SL500 230 VAC	G2RV-SL700-AP 230 VAC	G2RV-SL500-AP 230 VAC

#### Test switch type

Input voltage	Contact form (SPDT)			
	Standard type (Test switch type)		Input type (Test switch type)	
	Screw terminals	Push-in terminals	Screw terminals	Push-in terminals
24 VDC	G2RV-SL701 24 VDC	G2RV-SL501 24 VDC	---	---
24 VAC/DC	G2RV-SL701 24 VAC/DC	G2RV-SL501 24 VAC/DC	---	---

# Specifications

## Input Ratings

Rated voltage	Rated current <sup>*1</sup>			Must operate voltage	Must release voltage	Power consumption		Input voltage
	AC		DC			% of rated voltage	AC (VA) Approx.	DC (mW) Approx.
	50 Hz	60 Hz						
12 VDC	---	---	27.2 mA	80%	10%	---	300 mW	±10%
24 VDC	---	---	13.3 mA			---	300 mW	
24 VAC/DC	21.1 mA	22.5 mA	13.0 mA			0.5 VA	300 mW	
48 VAC/DC	8.5 mA	9.0 mA	5.2 mA			0.4 VA	250 mW	
110 VAC	7.1 mA	7.5 mA	---			0.8 VA	---	
230 VAC	7.3 mA	7.9 mA	---			1.7 VA	---	
						---	---	

\*1) Rated currents are measured at 23 degrees Celsius (ambient)

## Contact Ratings

Item	Standard type (G2RV-SL700, 500, 701, 501)		Input type (G2RV-SL700-AP, 500-AP) <sup>*2</sup>
Number of poles	1 pole		
Load	Resistive load (cosφ = 1)	Inductive load (cosφ = 0.4, L/R = 7 ms)	Resistive load (cosφ = 1)
Rated load	6 A at 250 VAC; 6 A at 30 VDC	2.5 A at 250 VAC; 2 A at 30 VDC	50 mA at 30 VAC; 50 mA at 36 VDC
Rated carry current	6 A		50 mA
Max. switching voltage	400 VAC, 125 VDC		30 VAC, 36 VDC
Max. switching current	6 A		50 mA
Max. switching power	1,500 VA 180 W	500 VA 60 W	---
Failure rate (reference value) <sup>*1</sup>	10 mA at 5 VDC (P level)		1 mA at 100 mVDC (P level)

\*1) P level:  $\lambda_{60} = 0.1 \times 10^{-6}/\text{operation}$

\*2) If a gold layer is destroyed, contact ratings of standard type are applicable.

## Characteristics

Item	Standard type (G2RV-SL700, 500, 701, 501)	Input type (G2RV-SL700-AP, 500-AP)
Contact resistance	100 mΩ max.	
Operate (set) time	20 ms max.	
Release time	40 ms max.	
Max. operating frequency	Mechanical: 18,000 operations/hr Electrical: 1,800 operations/hr (under rated load)	
Insulation resistance	1,000 MΩ min. (at 500 VDC)	
Dielectric strength	4,000 VAC, 50/60 Hz for 1 min between coil and contacts*; 1,000 VAC, 50/60 Hz for 1 min between contacts of same polarity	
Vibration resistance	Destruction: 10 to 55 to 10 Hz, 0.50 mm single amplitude (1.0 mm double amplitude) Malfunction: 10 to 55 to 10 Hz, 0.50 mm single amplitude (1.0 mm double amplitude)	
Shock resistance	Destruction: 1,000 m/s <sup>2</sup> Malfunction: 200 m/s <sup>2</sup> when energized; 100 m/s <sup>2</sup> when not energized	
Endurance	Mechanical: 5,000,000 operations min. Electrical: 100,000 Typical; NO 70,000 operations min. ; NC 50,000 operations min.	Mechanical: 5,000,000 operations min. Electrical: 5,000,000 operations min.
Ambient temperature	Operating: -40°C to 55°C (with no icing or condensation)	
Ambient humidity	Operating: 5% to 85%	
Weight	Approx. 35 g	
Overvoltage category	III	
Pollution degree	2	
Contact material	AgSnIn	AgSnIn + Gold Plating
Creepage distance	7.0 mm	
Clearance distance	5.5 mm	

Note: Values in the above table are the initial values.

## ■ Approved Standards

### UL 508 (File No. E41643)

Model	Contact form	Coil ratings	Contact ratings	Operations
G2RV-SL Series	SPDT	12 to 48 VDC 24 to 230 VAC	250 VAC 6 A (Resistive Load) 30 VDC 6 A (Resistive Load) 400 VAC 2 A (Resistive Load)	6,000

### IEC/VDE (EN 61810)

Contact form	Coil ratings	Contact ratings	Operations
SPDT	12, 24 VDC 24, 48 VAC/DC 110, 230 VAC	250 VAC 6 A (Resistive Load) 30 VDC 6 A (Resistive Load) 400 VAC 2 A (Resistive Load)	50,000 50,000 6,000

### Lloyd's (File No. 07/10027 (E2))

Model	Contact form	Coil ratings	Contact ratings
G2RV-SL Series	SPDT	12, 24 VDC 24, 48 VAC/DC 110, 230 VAC	250 VAC 6 A (Resistive load) 250 VAC 2.5 A (PF0.4) 30 VDC 6 A (Resistive load) 30 VDC 2 A (L/R=7ms)

## Engineering Data

### ■ Endurance

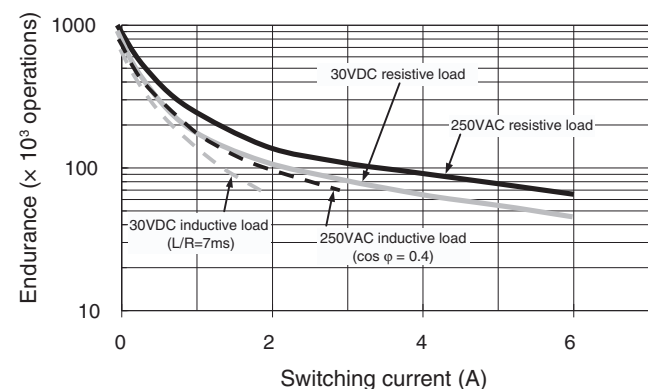

### Switching capacity of DC resistive load

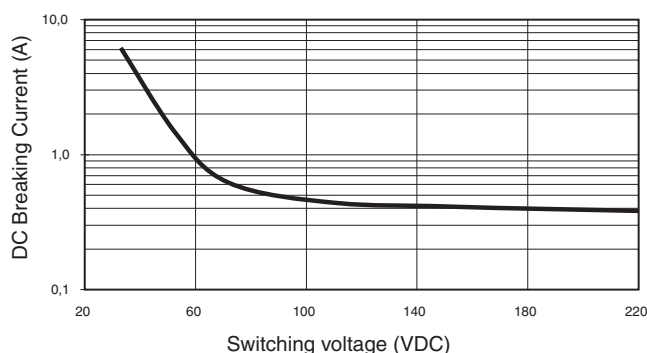

### Typical Operating and Release Time

Model number	Operating time (typical)	Release time (typical)
G2RV-SL7□□/5□□ DC12	5 ~ 7 ms	5 ~ 8 ms
G2RV-SL7□□/5□□ DC24	5 ~ 7 ms	6 ~ 9 ms
G2RV-SL7□□/5□□ AC/DC24	5 ~ 7 ms	17 ~ 22 ms
G2RV-SL7□□/5□□ AC/DC48	5 ~ 7 ms	22 ~ 30 ms
G2RV-SL7□□/5□□ AC110	12 ~ 15 ms	22 ~ 30 ms
G2RV-SL7□□/5□□ AC230	12 ~ 15 ms	22 ~ 30 ms

# Accessories

## ■ PLC Interface P2RVC-8-□-F

Contact form	Relay	PLC Interface
Standard type	G2RV-SL70□ series	P2RVC-8-O-F
Input type	G2RV-SL700-AP series	P2RVC-8-I-F

### P2RVC-8-O-F (for G2RV-SL70□ series only)

#### List of Models

Model number	Description	Connection
P2RVC-8-O-F	PLC Output Interface for 8x G2RV-SL70□-series PNP - type	Ribbon cable connector 10 Pole, IEC603/1

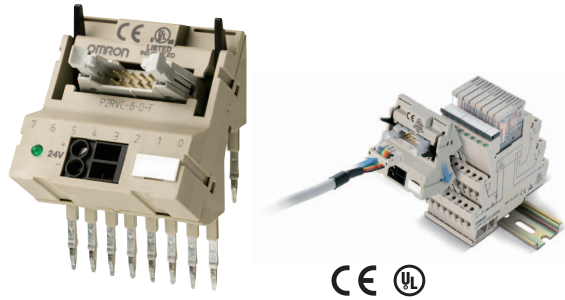

#### Specifications

Input	Rated voltage	30 VAC/VDC max.
	Current capacity	0.5 A per channel 2.0 A total current, power supply terminal
Characteristics	Ambient temperature	Operating: 0 to 55°C Storage: -20 to 85°C
	Overvoltage category	III
	Pollution degree	2

#### Electrical schematic P2RVC-8-O-F

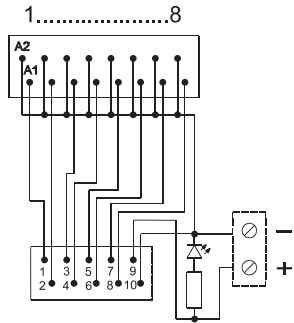

### P2RVC-8-I-F (for G2RV-SL700-AP series only)

#### List of Models

Model number	Description	Connection
P2RVC-8-I-F	PLC Output Interface for 8x G2RV-SL700-series PNP - type	Ribbon cable connector 10 Pole, IEC603/1

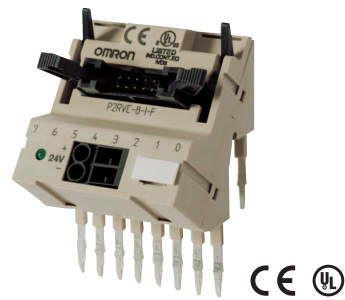

#### Specifications

Input	Rated voltage	30 VAC/VDC max.
	Current capacity	0.5 A per channel 2.0 A total current, power supply terminal
Characteristics	Ambient temperature	Operating: 0 to 55°C Storage: -20 to 85°C
	Overvoltage category	III
	Pollution degree	2

#### Electrical schematic P2RVC-8-I-F

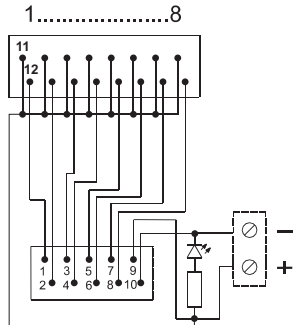

## ■ Cables for PLC Interface P2RVC-8-□-F

### Cables selection List

Output	
Model number	To be used for (combined with P2RVC-8-O-F)
P2RV-4-100C	CJ1W-OD232/OD262
P2RV-4-200C	CJ1W-OD232/OD262
P2RV-4-300C	CJ1W-OD232/OD262
P2RV-4-500C	CJ1W-OD232/OD262
P2RV-A100C	Universal (stranded wires)
P2RV-A200C	Universal (stranded wires)
P2RV-A300C	Universal (stranded wires)
P2RV-A500C	Universal (stranded wires)
P2RV-A050C-OMR GRT1	GRT1-OD8(G)-1
P2RV-A100C-OMR GRT1	GRT1-OD8(G)-1
P2RV-A050C-OMR NX	NX-OD4256
P2RV-A100C-OMR NX	NX-OD4256
P2RV-200C-SIM S7/300	6ES7 322-1BL00-0AA0, 32DO
P2RV-250C-SIM S7/300	6ES7 322-1BL00-0AA0, 32DO
P2RV-300C-SIM S7/300	6ES7 322-1BL00-0AA0, 32DO
P2RV-500C-SIM S7/300	6ES7 322-1BL00-0AA0, 32DO
P2RV-200C-SIM S7/400	6ES7422-1BL00-0AA0 & 6ES7422-7BL00-0AB0, 32DO
P2RV-250C-SIM S7/400	6ES7422-1BL00-0AA0 & 6ES7422-7BL00-0AB0, 32DO
P2RV-300C-SIM S7/400	6ES7422-1BL00-0AA0 & 6ES7422-7BL00-0AB0, 32DO
P2RV-500C-SIM S7/400	6ES7422-1BL00-0AA0 & 6ES7422-7BL00-0AB0, 32DO

Input	
Model number	To be used for (combined with P2RVC-8-I-F)
P2RV-4-100IFC	CJ1W-ID231/ID233/ID261
P2RV-4-100IMC	CJ1W-ID233/ID262
P2RV-4-200IFC	CJ1W-ID231/ID233/ID261
P2RV-4-200IMC	CJ1W-ID233/ID262
P2RV-4-300IFC	CJ1W-ID231/ID233/ID261
P2RV-4-300IMC	CJ1W-ID233/ID262
P2RV-4-500IFC	CJ1W-ID231/ID233/ID261
P2RV-4-500IMC	CJ1W-ID233/ID262
P2RV-A100C	Universal (stranded wires)
P2RV-A200C	Universal (stranded wires)
P2RV-A300C	Universal (stranded wires)
P2RV-A500C	Universal (stranded wires)
P2RV-A050IC-OMR GRT1	GRT1-ID8-1
P2RV-A100IC-OMR GRT1	GRT1-ID8-1
P2RV-A050IC-OMR NX	NX-ID4442
P2RV-A100IC-OMR NX	NX-ID4442
P2RV-200C-SIM S7/300	6ES7 321-1BL00-0AA0, 32DI
P2RV-250C-SIM S7/300	6ES7 321-1BL00-0AA0, 32DI
P2RV-300C-SIM S7/300	6ES7 321-1BL00-0AA0, 32DI
P2RV-500C-SIM S7/300	6ES7 321-1BL00-0AA0, 32DI
P2RV-200C-SIM S7/400	6ES7421-1BL00-0AA0 & 6ES7421-1BL01-0AA0, 32DI
P2RV-250C-SIM S7/400	6ES7421-1BL00-0AA0 & 6ES7421-1BL01-0AA0, 32DI
P2RV-300C-SIM S7/400	6ES7421-1BL00-0AA0 & 6ES7421-1BL01-0AA0, 32DI
P2RV-500C-SIM S7/400	6ES7421-1BL00-0AA0 & 6ES7421-1BL01-0AA0, 32DI

### P2RV-4-□□□C

### P2RV-4-□□□IMC

### P2RV-4-□□□IFC

Cable to connect CJ1 to 4 × P2RVC-8-□-F

#### List of Models

I/O	Model number	Cable length	Interface unit	PLC Connection	Connectors
Output	P2RV-4-100C	1.0 m	P2RVC-8-O-F × 4	OMRON PLC CJ1 Series: MIL	MIL40 - MIL10 × 4
	P2RV-4-200C	2.0 m			
	P2RV-4-300C	3.0 m			
	P2RV-4-500C	5.0 m			
Input	P2RV-4-100IMC	1.0 m	P2RVC-8-I-F × 4	OMRON PLC CJ1 Series: MIL	MIL40 - MIL10 × 4
	P2RV-4-200IMC	2.0 m			
	P2RV-4-300IMC	3.0 m			
	P2RV-4-500IMC	5.0 m			
Input	P2RV-4-100IFC	1.0 m	P2RVC-8-I-F × 4	OMRON PLC CJ1 Series: Fujitsu	FCN40 - MIL10 × 4
	P2RV-4-200IFC	2.0 m			
	P2RV-4-300IFC	3.0 m			
	P2RV-4-500IFC	5.0 m			

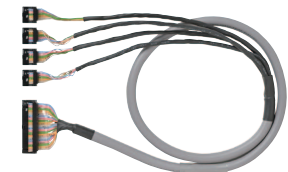

P2RV-4-□□□C/P2RV-4-□□□IMC



P2RV-4-□□□IFC

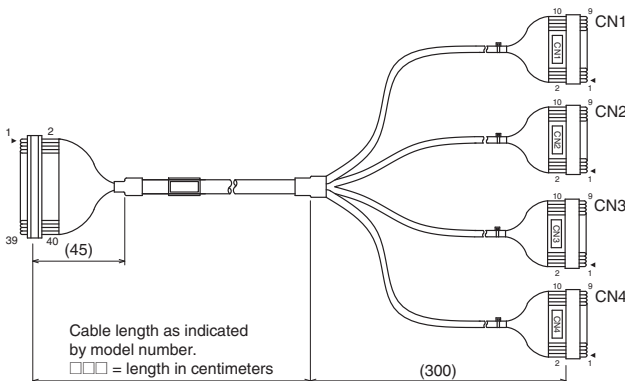

P2RV-4-□□□C/P2RV-4-□□□IMC

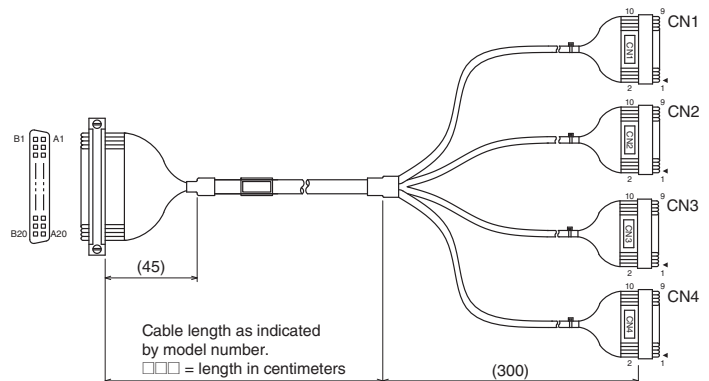

P2RV-4-□□□IFC

### 4 x 10 pole IDC mounting to 4 x P2RVC-8-□-F

P2RV-4-□□□C

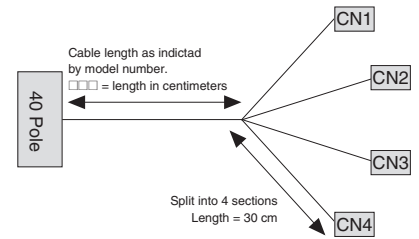
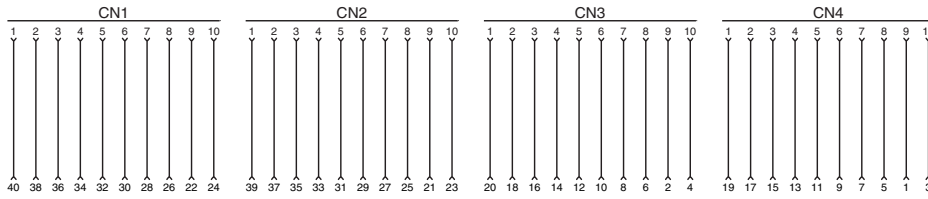

P2RV-4-□□□IMC

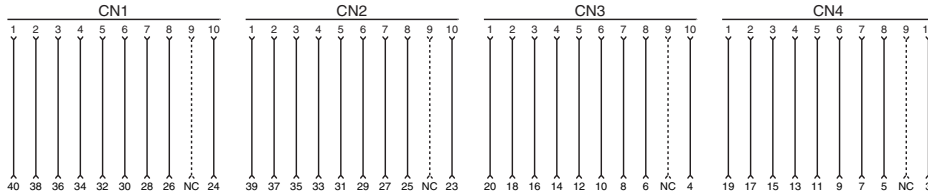

P2RV-4-□□□IFC

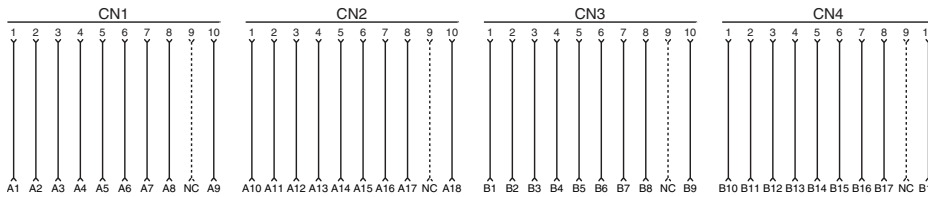

40 pole IDC mounting to Omron PLC CJ1-OD232

### Technical data

Control line	AWG28/0.08 mm <sup>2</sup> , tin-plated copper
Diameter cable	10.7 mm (one end splits into 4 sections: A, B, C, D)
Operating voltage	60 VDC
Continuous current per signal wire	0.5 A
Max. total current, 4 bytes, each	1.0 A
Test voltage	0.5 KV, 50 Hz, 1 min
Operating temperature range	-20°C to +50°C

### P2RV-A□□□C

Cable, single sided 10 pole IDC connector, to connect to P2RVC-8-□-F

#### List of Models

I/O	Model number	Cable length	Interface unit	PLC interface	Connectors
Universal (Output/ Input)	P2RV-A100C	1.0 m	P2RVC-8-□-F	-	MIL10 - No connector
	P2RV-A200C	2.0 m			
	P2RV-A300C	3.0 m			
	P2RV-A500C	5.0 m			

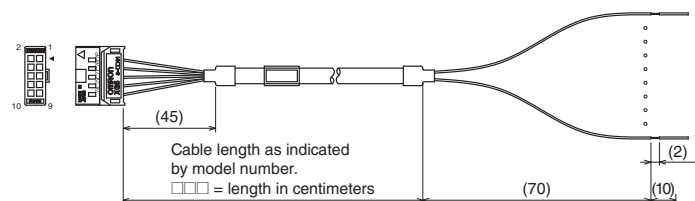
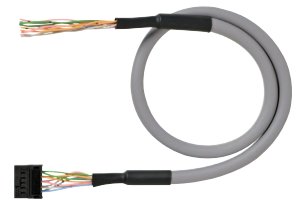

10 pole IDC mounting to P2RVC-8-□-F

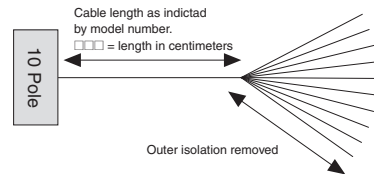

Technical data

Control line	AWG26/0.14 mm <sup>2</sup> , tin-plated copper
Diameter cable	7.6 mm
Operating voltage	60 VDC
Continuous current per signal wire	0.5 A
Max. total current	1.0 A
Test voltage	0.5 KV, 50 Hz, 1 min
Operating temperature range	-20°C to +50°C

P2RV-A□□□C-OMR GRT1

P2RV-A□□□IC-OMR GRT1

List of Models

I/O	Model number	Cable length	Interface unit	PLC interface	Connectors
Output	P2RV-A050C-OMR GRT1	0.5 m	P2RVC-8-O-F	OMRON Smart slice I/O module GRT1 Series GRT1-OD8(G)-1	XW7E 12pole - MIL10
	P2RV-A100C-OMR GRT1	1.0 m			
Input	P2RV-A050IC-OMR GRT1	0.5 m	P2RVC-8-I-F	OMRON Smart slice I/O module GRT1 Series GRT1-ID9(G)-1	XW7E 12pole - MIL10
	P2RV-A100IC-OMR GRT1	1.0 m			

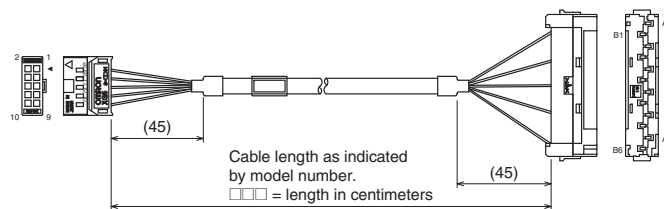
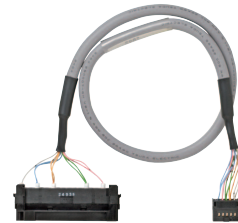

10 pole IDC mounting to P2RVC-8-□-F

P2RV-A□□□C-OMR GRT1

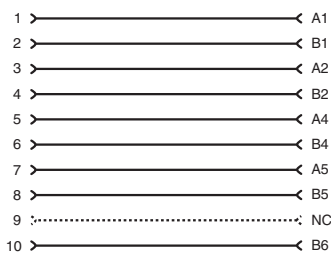

P2RV-A□□□IC-OMR GRT1

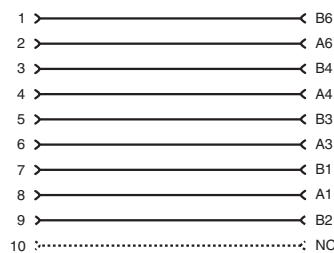



**P2RV-A□□□C-OMR NX**  
**P2RV-A□□□IC-OMR NX**

**List of Models**

I/O	Model number	Cable length	Interface unit	PLC interface	Connectors
Output	P2RV-A050C-OMR GRT1	0.5 m	P2RVC-8-O-F	OMRON I/O module NX Series	XW7F 16pole-MIL10
	P2RV-A100C-OMR GRT1	1.0 m			
Input	P2RV-A050IC-OMR GRT1	0.5 m	P2RVC-8-I-F	OMRON I/O module NX Series	XW7F 16pole-MIL10
	P2RV-A100IC-OMR GRT1	1.0 m			

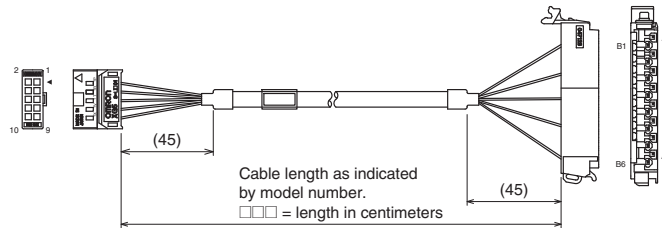
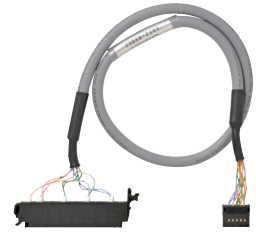

**10 pole IDC mounting to P2RVC-8-□-F**

P2RV-A□□□C-OMR NX

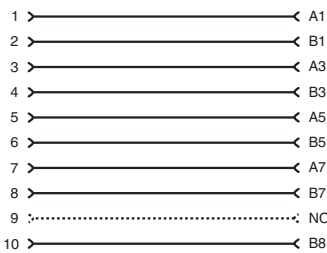

P2RV-A□□□IC-OMR NX

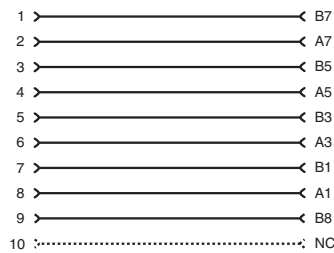

**P2RV-□□□C-SIM S7/□00**

Cables to connect Siemens S7/300 or S7/400 to 4 x P2RVC-8-□-F

**List of Models**

Model number	Cable length	PLC type	Configuration
P2RV-200C-SIM S7/300	2.0 m	Siemens S7/300 4x1 Byte	
P2RV-250C-SIM S7/300	2.5 m		
P2RV-300C-SIM S7/300	3.0 m		
P2RV-500C-SIM S7/300	5.0 m		
P2RV-200C-SIM S7/400	2.0 m	Siemens S7/400 4x1 Byte	
P2RV-250C-SIM S7/400	2.5 m		
P2RV-300C-SIM S7/400	3.0 m		
P2RV-500C-SIM S7/400	5.0 m		

## ■ Single Relays for Maintenance

### Model Number Legend

G2RV-□ - □ □ □ - □ - □  
 1 2 3 4 5 6

**1. Number of Poles**

1: 1 pole

**2. Terminals**

S: Plug-In

**3. Relay LED**

Blank: Without LED

**4. Relay Test switch**

Blank: No test switch

I: Test switch

**5. Contact Material**

Blank: AgSnIn

AP: AgSnIn hard gold-plated

**6. Rated Coil Voltage**

11 VDC, 21 VDC, 48 VDC

### List of Models

Model number	Replacement for
G2RV-1-S 11 VDC	G2RV-SL700/500 12 VDC
G2RV-1-S 21 VDC	G2RV-SL700/500 24 VDC
	G2RV-SL700/500 24 VAC/DC
G2RV-1-S 48 VDC	G2RV-SL700/500 48 VAC/DC
	G2RV-SL700/500 110 VAC
	G2RV-SL700/500 230 VAC
G2RV-1-S-AP 11 VDC	G2RV-SL700/500-AP 12 VDC
G2RV-1-S-AP 21 VDC	G2RV-SL700/500-AP 24 VDC
	G2RV-SL700/500-AP 24 VAC/DC
G2RV-1-S-AP 48 VDC	G2RV-SL700/500-AP 48 VAC/DC
	G2RV-SL700/500-AP 110 VAC
	G2RV-SL700/500-AP 230 VAC
G2RV-1-SI 21 VDC	G2RV-SL701/501 24 VDC
	G2RV-SL701/501 24 VAC/DC

G2RV-1-SI



G2RV-1-S



## ■ Cross bars

### Model Number Legend

P2RVM -□ □  
 1 2

**1. Number of Poles**

020: 2 poles

030: 3 poles

040: 4 poles

100: 10 poles

200: 20 poles

**2. Color**

R: Red

S: Blue

B: Black

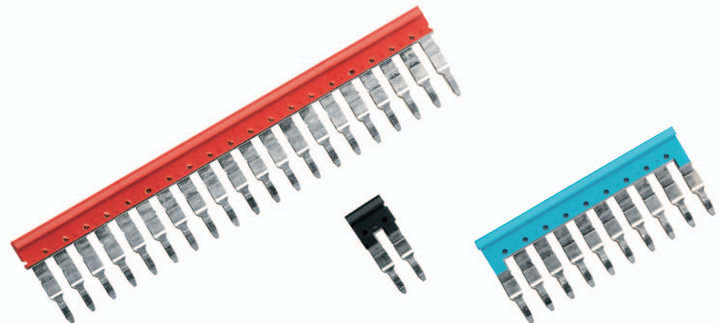

### List of Models

Model number	Poles	Color
P2RVM-020□	2	Red (R) Blue (S) Black (B)
P2RVM-030□	3	
P2RVM-040□	4	
P2RVM-100□	10	
P2RVM-200□	20	

□ select color: R = Red, S=Blue, B=Black

### Specification

<b>Max current</b> (EN60947-7-1 section 8.3.3 / 1991)	32 A
<b>Max. Voltage</b>	400 VAC
<b>Max. Voltage</b> when cutting Cross-bar without using separation plate or end-bracket	250 VAC

## ■ Plastic Labels for G2RV Sockets

Model number	Box quantity	Color
R99-15 for G2RV	1 piece = 1 sheet = 120 labels	White

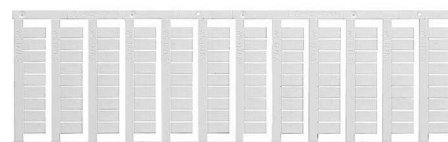

## ■ Labels (Stickers) for G2RV Sockets

Model number	Box quantity	Color
R99-16 for G2RV	1 piece = 1 sheet = 484 labels (stickers)	White

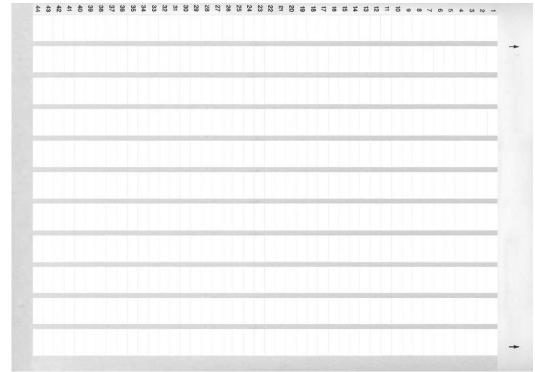

## ■ Separating Plates

Model number	Description
P2RV-S	Provides isolation between adjacent relays to achieve 400 V isolation.



# Dimensions

Note: All units are in millimeters unless otherwise indicated.

## Complete Unit

G2RV-SL700  
G2RV-SL700-AP

### Dimensions

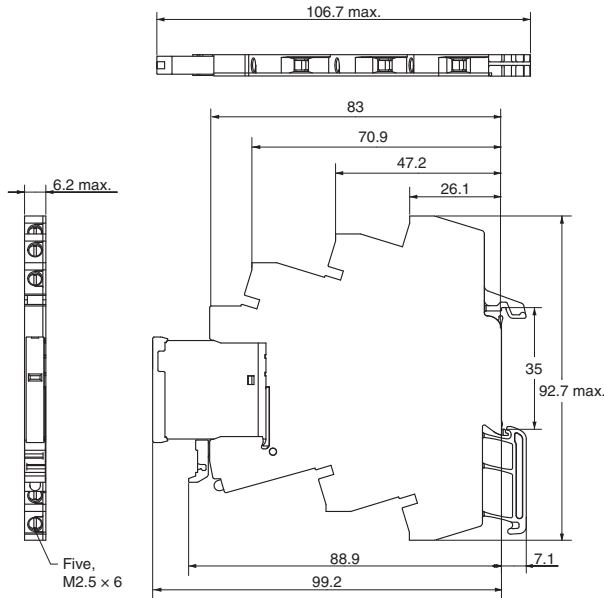

### Terminal Arrangement

#### Input circuit

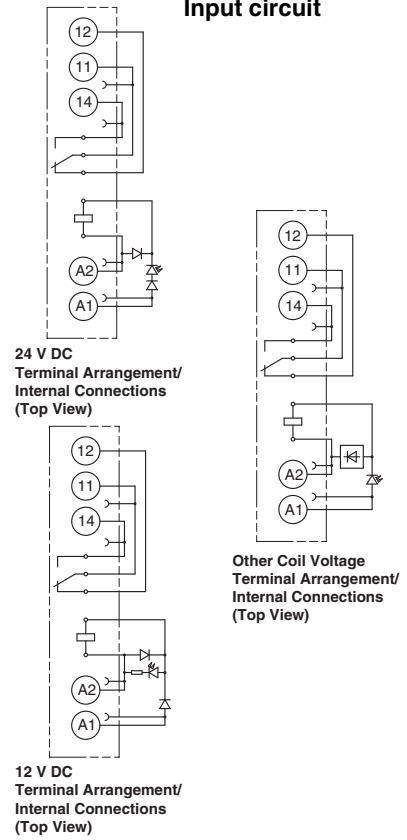

G2RV-SL701

### Dimensions

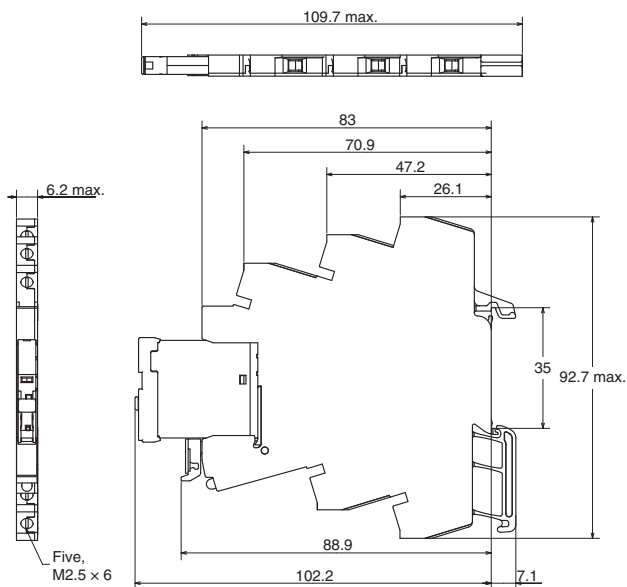

### Terminal Arrangement

#### Input circuit

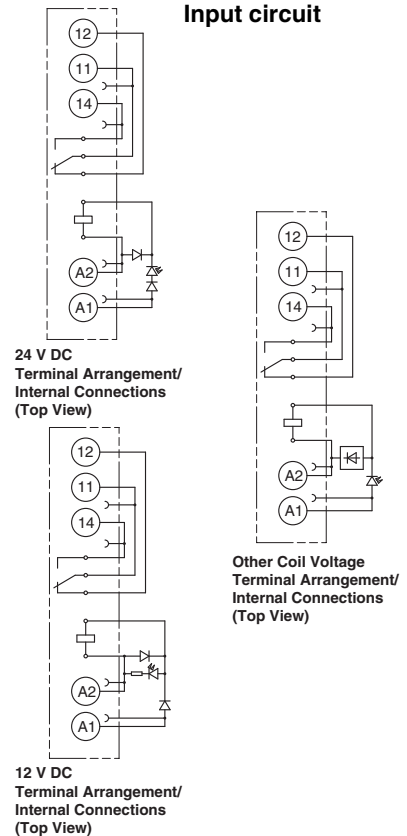

**G2RV-SL500  
G2RV-SL500-AP**

**Dimensions**

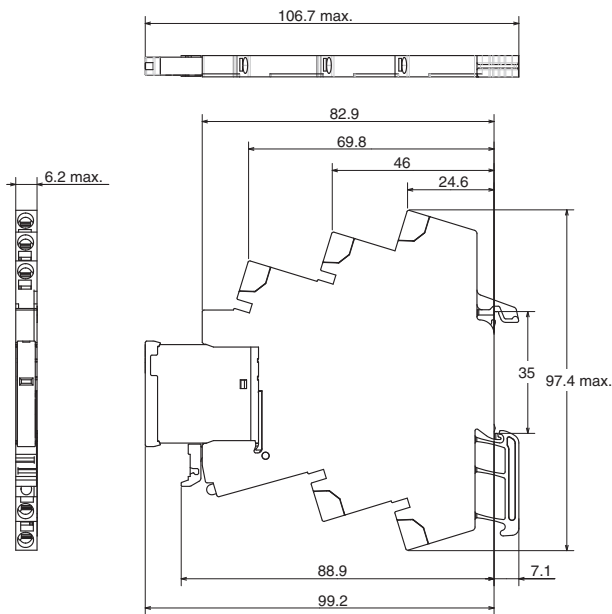

**Terminal Arrangement**

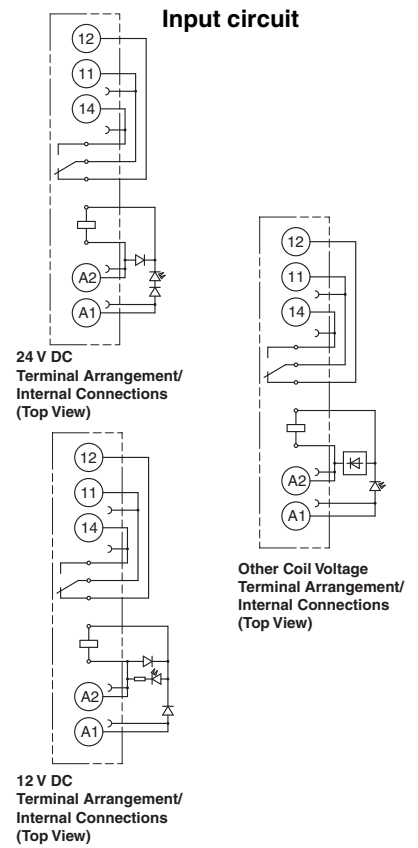

**G2RV-SL501**

**Dimensions**

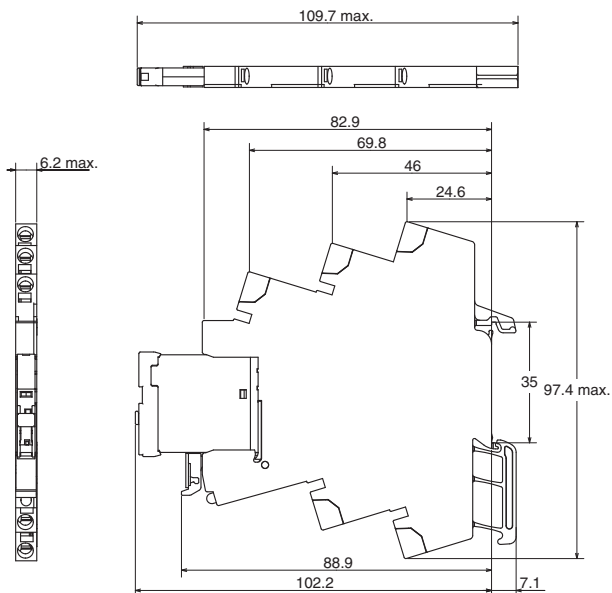

**Terminal Arrangement**

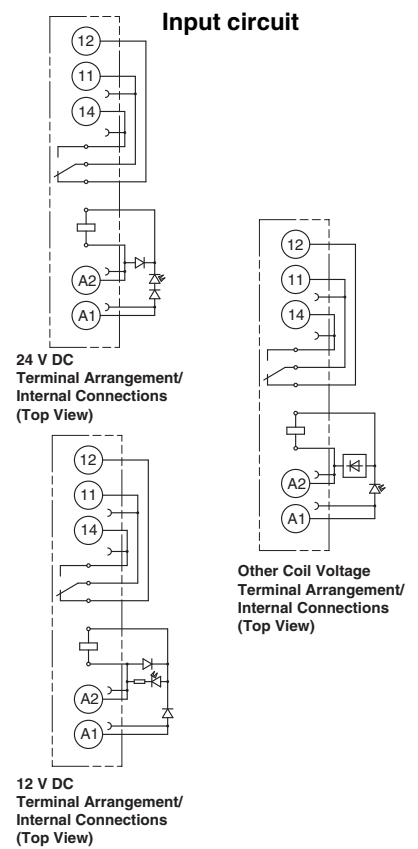

**Single Relay**

**G2RV-1-S  
G2RV-1-S-AP**

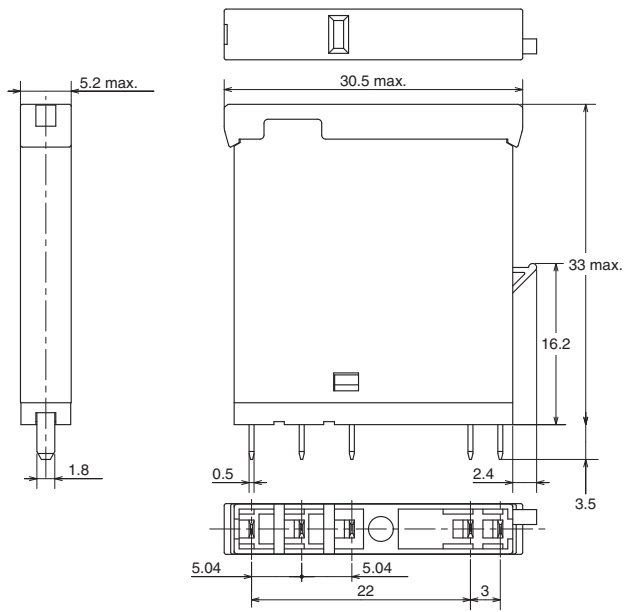

**Input circuit**

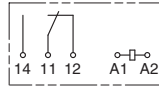

**Terminal Arrangement/  
Internal Connections  
(Bottom View)**

**G2RV-1-SI**

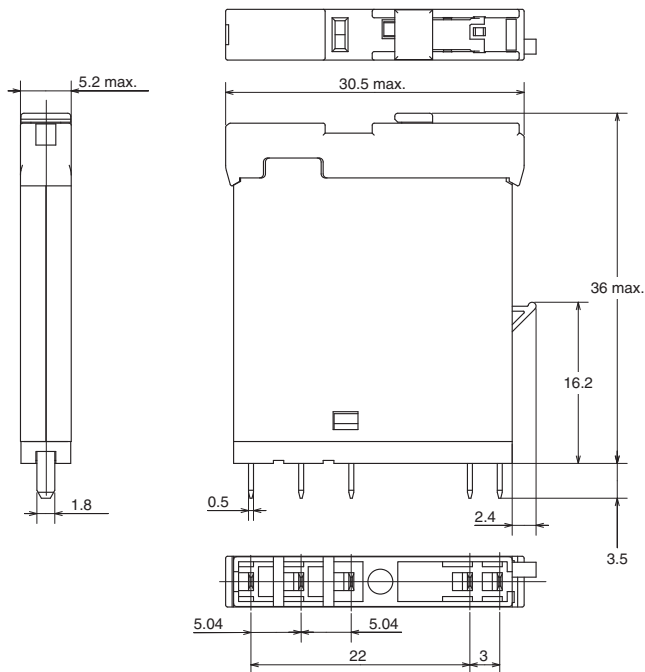

**Input circuit**

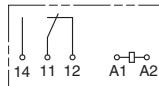

**Terminal Arrangement/  
Internal Connections  
(Bottom View)**

# Installation

## Tools

G2RV-SL70□ series: Flat-Blade screwdriver should be used for mounting and / or releasing cables.

G2RV-SL50□ series: Flat-Blade screwdriver should be used for mounting stranded wires without ferrules and / or releasing cables.

### Applicable Screwdriver

- Flat-blade, Parallel-tip, 2.5 mm diameter (3.0 mm max.)

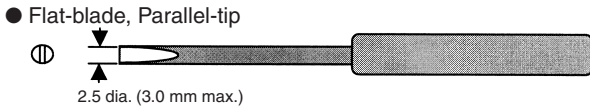

Cannot be used.

- Examples: FACOM AEF.2.5×75E (AEF. 3×75E)  
 VESSEL No. 9900-(-)2.5×75 (No. 9900-(-)3×100)  
 WAGO 210-119  
 WIHA 260/2.5×40 (260/3×50)

\*Chamfering the tip of the driver improves insertion when used as an exclusive tool.

## P2RVC-8-O-F (for G2RV-SL70□ series only)

### List of Models

Model number	Description	Connection
P2RVC-8-O-F	PLC Output Interface for 8x G2RV-SL70□-series PNP - type	Ribbon cable connector 10 Pole, IEC603/1

## Applicable Wires

### Applicable Wire Sizes

#### G2RV-SL700 Series

##### Box clamp technology

Wire type	Applicable wire size	Stripping length
Stranded without ferrules	0.5 - 2.5 mm <sup>2</sup>	7 mm
Stranded with ferrules and plastic collar	0.5 - 2.5 mm <sup>2</sup>	7 mm
Stranded with ferrules without plastic collar	0.5 - 2.5 mm <sup>2</sup>	7 mm
Solid	0.5 - 2.5 mm <sup>2</sup>	7 mm

#### G2RV-SL500 Series

##### Push-in technology

Wire type	Applicable wire size	Stripping length
Stranded without ferrules	0.5 - 2.5 mm <sup>2</sup>	12 mm
Stranded with ferrules and plastic collar	0.5 - 2.5 mm <sup>2</sup>	12 mm
Stranded with ferrules without plastic collar	0.5 - 2.5 mm <sup>2</sup>	12 mm
Solid	0.5 - 2.5 mm <sup>2</sup>	12 mm

## ■ Wiring

Use wires of the applicable sizes specified above. The length of the exposed conductor should be 7 mm for a G2RV-SL700 series, 12 mm for a G2RV-SL500 series.

G2RV-SL700



G2RV-SL500

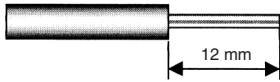
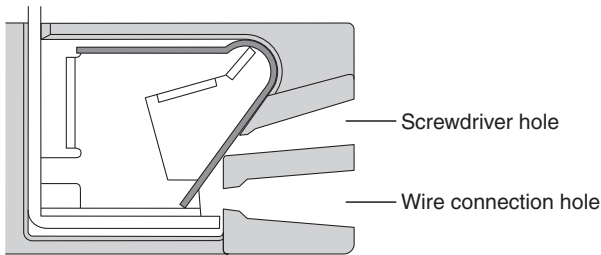
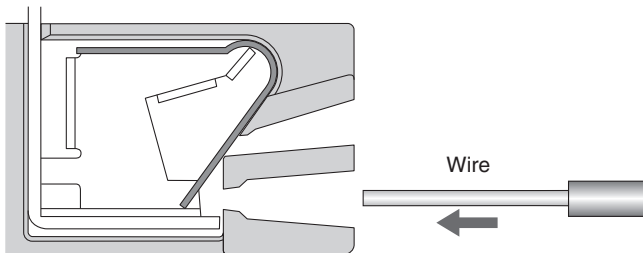

Fig. 1 Exposed Conductor Length

### Wiring Procedure for G2RV-SL500 series



#### ● Wiring



Insert the exposed conductor into the connection hole.

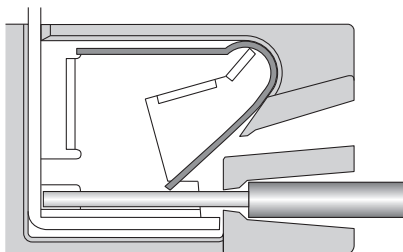

No other tools are required.

**Note:** In case of wiring stranded wires without ferrules screwdriver should be inserted before inserting the wire.  
Screwdriver should be removed after fully insertion of the wire.

#### ● Removing

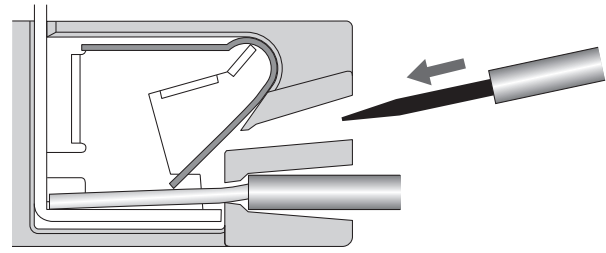

Insert the specified screwdriver into the release hole.

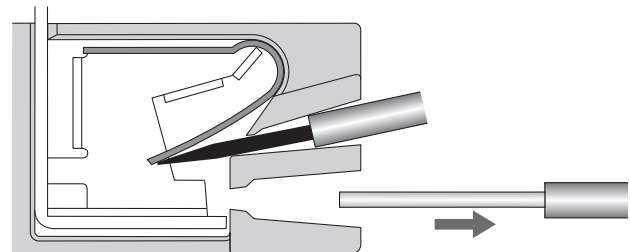

Removing wire.

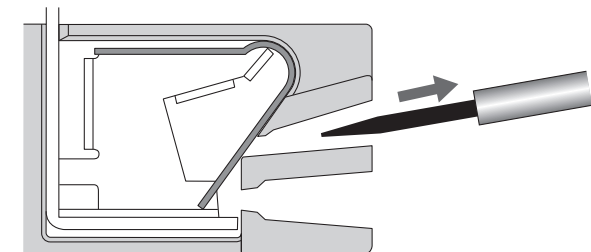

Removing screwdriver.



# Precautions

## Precautions for Connection

- Do not move the screwdriver up, down, or from side to side while it is inserted in the hole. Doing so may cause damage to internal components (e.g., deformation of the clamp spring or cracks in the housing) or cause deterioration of insulation.
- Do not insert the screwdriver at an angle. Doing so may break the side of socket and result in a short-circuit.

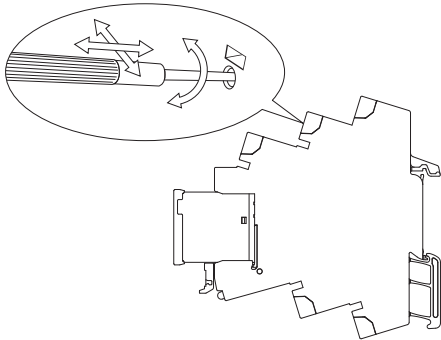

- Do not insert two or more wires in the hole. Wires may come in contact with the spring causing a temperature rise or be subject to sparks.

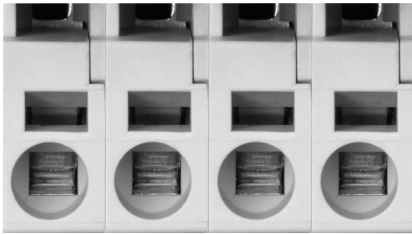

- Insert the screwdriver along the hole wall as shown below.

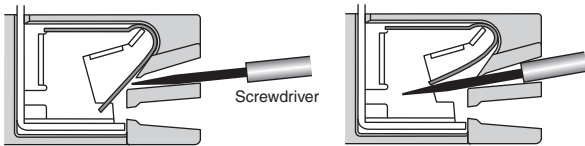

- If lubricating liquid, such as oil, is present on the tip of screwdriver, the screwdriver may fall out resulting in injury to the operator.
- Insert the screwdriver into the bottom of the hole. It may not be possible to connect cables properly if the screwdriver is inserted incorrectly.

## General Precautions

- Do not use the product if it has been dropped on the ground. Dropping the product may adversely affect performance.
- Confirm that the socket is securely attached to the mounting track before wiring. If the socket is mounted insecurely it may fall and injure the operator.
- Ensure that the socket is not charged during wiring and maintenance. Not doing so may result in electric shock.

- Do not pour water or cleansing agents on the product. Doing so may result in electric shock.
- Do not use the socket in locations subject to solvents or alkaline chemicals.
- Do not use the socket in locations subject to ultraviolet light (e.g., direct sunlight). Doing so may result in markings fading, rust, corrosion, or resin deterioration.
- Do not dispose the product in fire.

## Removing from Mounting Rail

To remove the socket from the mounting rail, insert the tip of screwdriver in the fixture rail, and move it in the direction shown below.

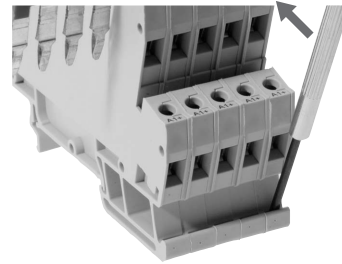

## Precaution for Operation of Test switch

■ **Tool: G2RV-SL701/501 series: 2.5 mm width Flat-Blade screwdriver should be used for operation of test switch.**

- Flat-blade, Parallel-tip, 2.5 mm diameter (3.0 mm max.)

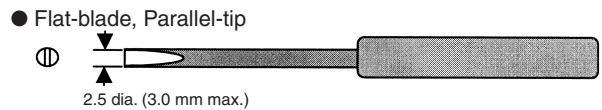

**Cannot be used.**

### ■ Cautions:

- When you operate a test switch, please turn off electrical power supply.
- After you have finished to operate a test switch, return the test switch to its original state
- Do not use test switch as a switch.
- Durability of test switch operation is more than 100 times.
- Please avoid to use the latching lever by ON state with carry current in long time, more than 24 hours to maintain the initial performance for operation checking.

**ALL DIMENSIONS SHOWN ARE IN MILLIMETERS.**

To convert millimeters into inches, multiply by 0.03937. To convert grams into ounces, multiply by 0.03527.