

# ACE1V4532

## Automotive grade common-mode chip inductor



### Product features

- AEC-Q200 qualified
- 1812 (4532 metric) package
- Impedance range from 700 ohms to 15000 ohms
- Inductance range from 11 uH to 200 uH
- Moisture sensitivity level (MSL): 1

### Applications

- Controller area network (CAN)
- Ethernet architectures
- Automotive signal line filter
- Advanced driver assistance systems (ADAS)
- Infotainment, safety cameras, sensors, xEV, Powertrain
- Engine control unit (ECU)
- Electric power steering system (EPS)
- Battery management systems (BMS)

### Environmental compliance and general specifications

- Operating temperature range: -40 °C to +125 °C (ambient plus self-temperature rise)
- Solder reflow temperature: J-STD-020 (latest revision) compliant



**Product specifications**

Part number	Common-mode impedance Z (Ω) at 10 MHz	Common-mode inductance (μH) at 100 kHz	DCR (Ω) @ +25 °C maximum	Idc (mA) maximum	Rated voltage (Vdc) typical	Insulation resistance (MΩ) minimum
ACE1V4532-110-R	300 minimum 700 typical	11 +50%/-30%	0.60	250	50	10
ACE1V4532-220-R	500 minimum 1000 typical	22 +50%/-30%	1.00	200	50	10
ACE1V4532-510-R	1000 minimum 2000 typical	51 +50%/-30%	1.00	200	50	10
ACE1V4532-101-R	2000 minimum 5000 typical	100 +50%/-30%	2.00	150	50	10
ACE1V4532-201-R	10000 minimum 15000 typical	200 +50%/-30%	4.50	100	50	10

1. Part Number Definition: ACE1V4532-xxn-R  
 ACE1V4532 = Product code and size  
 xx= inductance value in uH,  
 n= multiplication factor: 10^n (i.e. 110 = 11 \* 10^0 = 11 uH)  
 -R suffix = RoHS compliant

**Mechanical parameters, schematic, pad layout (mm)**

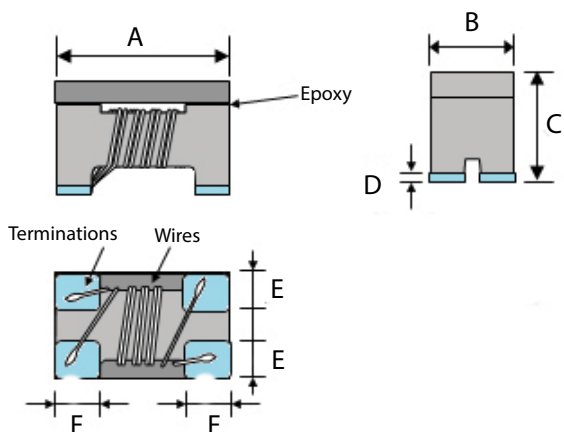

**Recommended pad layout**

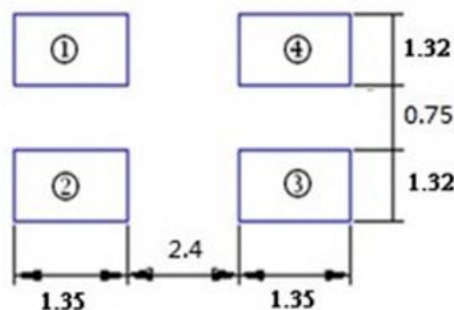

**Equivalent circuit**

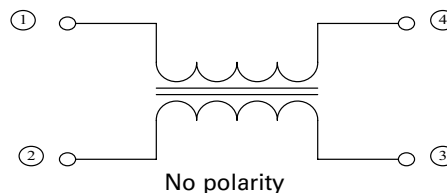

Part Number	A	B	C	D	E	F
ACE1V4532-xxn-R	4.5±0.2	3.2 ±0.2	2.8 ±0.2	0.2 ±0.1	1.2typ.	1.0typ.

All soldering surfaces to be coplanar within 0.1 millimeters  
 Tolerances are ±0.1 millimeters unless stated otherwise  
 Pad layout dimensions are reference only  
 Traces or vias underneath the inductor is not recommended

**Packaging information (mm)**

Supplied in tape and reel packaging, 500 parts per 7" diameter reel

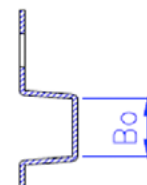
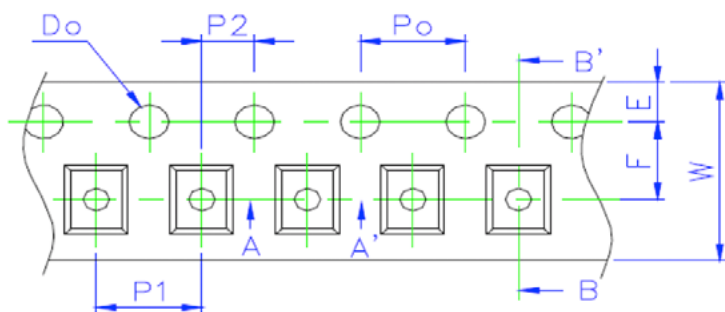

SEC: B-B'

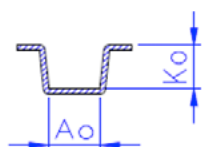

SEC: A-A'

$A_o$	$3.45 \pm 0.10$
$B_o$	$4.90 \pm 0.10$
$K_o$	$3.05 \pm 0.10$
$W$	$12.00 \pm 0.20$
$E$	$1.75 \pm 0.10$
$F$	$5.50 \pm 0.05$
$P_o$	$4.0 \pm 0.05$
$P_1$	$8.0 \pm 0.10$
$D_o$	$1.5 + 0.1, -0$

Performance curves

ACE1V4532-110-R

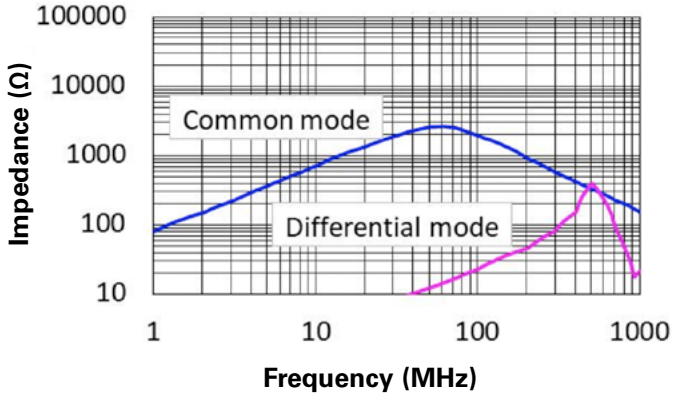

ACE1V4532-220-R

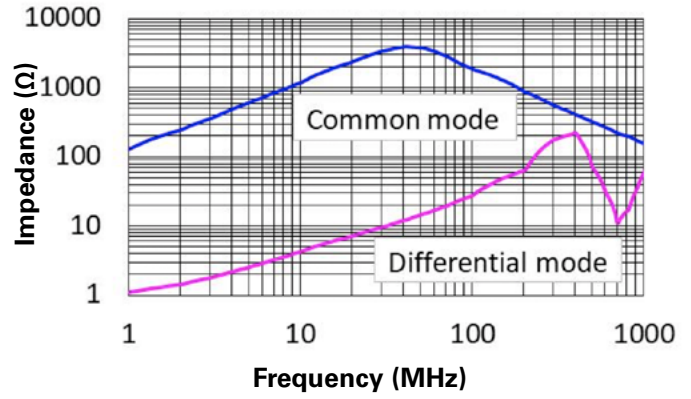

ACE1V4532-510-R

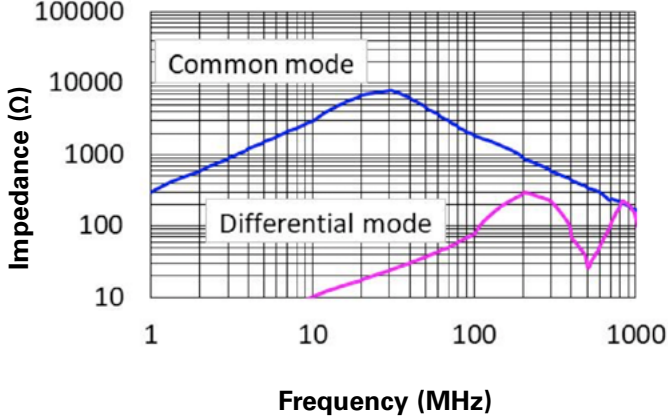

ACE1V4532-101-R

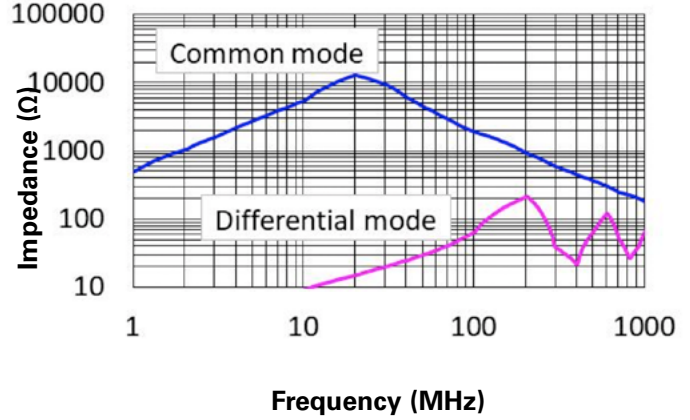

ACE1V4532-201-R

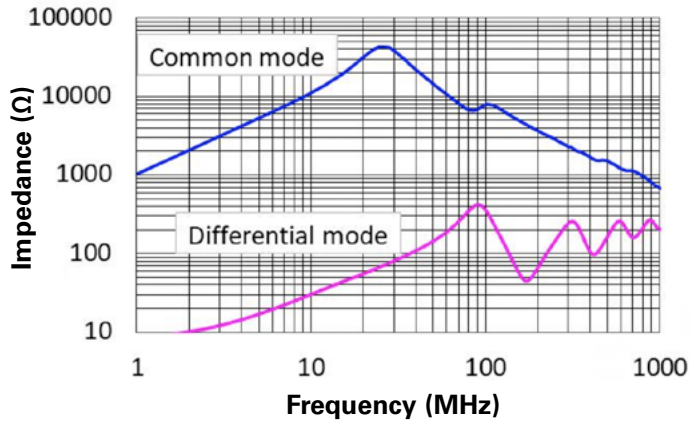

Common mode measurement method:

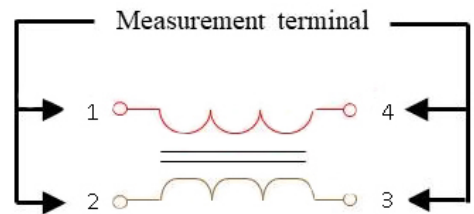

Differential mode measurement method:

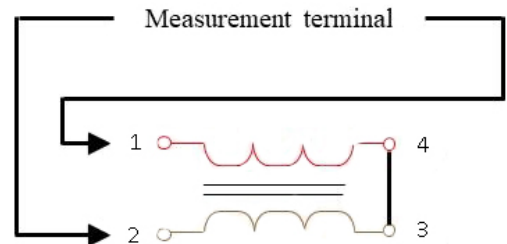

**Solder reflow profile**

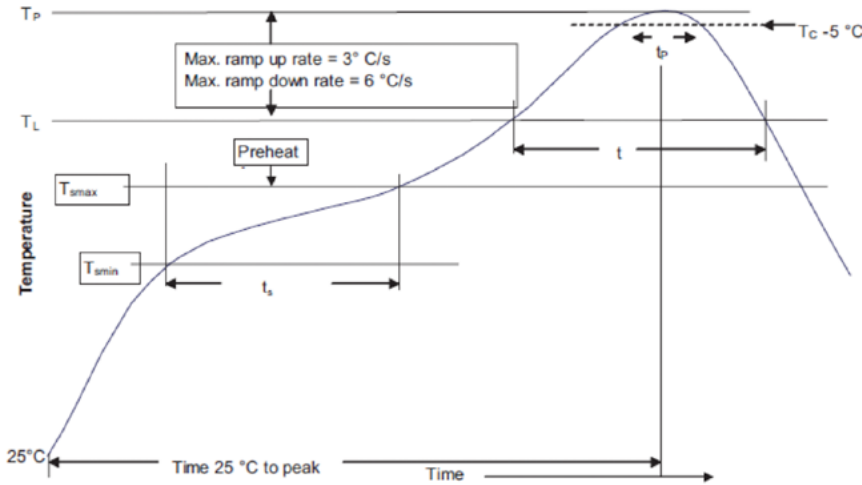

**Table 1 - Standard SnPb solder (T<sub>C</sub>)**

Package Thickness	Volume mm <sup>3</sup> <350	Volume mm <sup>3</sup> ≥350
<2.5 mm	235 °C	220 °C
≥2.5 mm	220 °C	220 °C

**Table 2 - Lead (Pb) free solder (T<sub>C</sub>)**

Package thickness	Volume mm <sup>3</sup> <350	Volume mm <sup>3</sup> 350 - 2000	Volume mm <sup>3</sup> >2000
<1.6 mm	260 °C	260 °C	260 °C
1.6 – 2.5 mm	260 °C	250 °C	245 °C
>2.5 mm	250 °C	245 °C	245 °C

**Reference J-STD-020**

Profile feature	Standard SnPb solder	Lead (Pb) free solder
Preheat and soak		
• Temperature min. (T <sub>smin</sub> )	100 °C	150 °C
• Temperature max. (T <sub>smax</sub> )	150 °C	200 °C
• Time (T <sub>smin</sub> to T <sub>smax</sub> ) (t <sub>s</sub> )	60-120 seconds	60-120 seconds
Ramp up rate T <sub>L</sub> to T <sub>P</sub>	3 °C/ second max.	3 °C/ second max.
Liquidous temperature (T <sub>L</sub> )	183 °C	217 °C
Time (t <sub>L</sub> ) maintained above T <sub>L</sub>	60-150 seconds	60-150 seconds
Peak package body temperature (T <sub>P</sub> )*	Table 1	Table 2
Time (t <sub>p</sub> )* within 5 °C of the specified classification temperature (T <sub>C</sub> )	20 seconds*	30 seconds*
Ramp-down rate (T <sub>P</sub> to T <sub>L</sub> )	6 °C/ second max.	6 °C/ second max.
Time 25 °C to peak temperature	6 minutes max.	8 minutes max.

\* Tolerance for peak profile temperature (T<sub>P</sub>) is defined as a supplier minimum and a user maximum.

Life Support Policy: Eaton does not authorize the use of any of its products for use in life support devices or systems without the express written approval of an officer of the Company. Life support systems are devices which support or sustain life, and whose failure to perform, when properly used in accordance with instructions for use provided in the labeling, can be reasonably expected to result in significant injury to the user.

Eaton reserves the right, without notice, to change design or construction of any products and to discontinue or limit distribution of any products. Eaton also reserves the right to change or update, without notice, any technical information contained in this bulletin.

**Eaton**  
**Electronics Division**  
1000 Eaton Boulevard  
Cleveland, OH 44122  
United States  
Eaton.com/electronics

© 2019 Eaton  
All Rights Reserved  
Printed in USA  
Publication No. 10986 BU-MC19114  
November 2019

Eaton is a registered trademark.

All other trademarks are property of their respective owners.

Follow us on social media to get the latest product and support information.



# Mouser Electronics

Authorized Distributor

Click to View Pricing, Inventory, Delivery & Lifecycle Information:

Eaton:

[ACE1V4532-101-R](#) [ACE1V4532-110-R](#) [ACE1V4532-201-R](#) [ACE1V4532-220-R](#) [ACE1V4532-510-R](#)