

16 K × 1 High Speed CMOS SRAM

Introduction

The HM 65767B is a high speed CMOS static RAM organized as 16384x1 bit. It is manufactured using MHS's high performance CMOS technology.

Access times as fast as 25 ns are available with maximum power consumption of only 385 mW.

The HM 65767B features fully static operation requiring no external clocks or timing strobes. The automatic power-down feature reduces the power consumption by 70 % when the circuit is deselected.

Easy memory expansion is provided by an active low chip select (\overline{CS}) and three state drivers.

All inputs and outputs of the HM 65767B are TTL compatible and operate from single 5 V supply thus simplifying system design.

The HM 65767B is 100 % processed following the test methods of MIL STD 883 and/or ESA/SCC 9000 making it ideally suitable for military/space applications that demand superior levels of performance and reliability.

Features

- Fast access time
Commercial : 25/35/45/55 ns (max)
Military : 25/35/45/55 ns (max)
- Low power consumption
Active : 385 mW (max)
Standby : 110 mW (max)
- Wide temperature range :
- 55°C to + 125°C
- 300 mils width package
- TTL compatible inputs and outputs
- Asynchronous
- Capable of withstanding greater than 2000 V electrostatic discharge
- Single 5 volt supply

Interface

Block Diagram

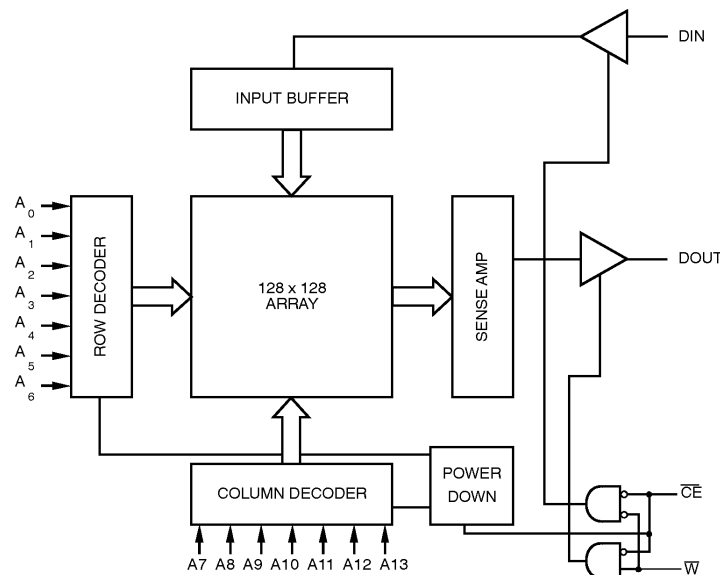

HM 65767B

Pin Configuration

Plastic 300 mils, 20 pins, DIL
 Ceramic 300 mils, 20 pins, DIL
 SOIC 300 mils, 20 pins

LCC, 20 pins

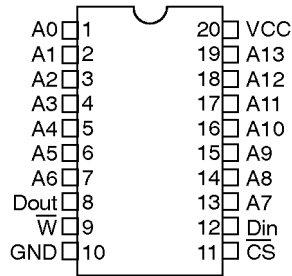

Pinout DIL/SOIC 20 pins (top view)

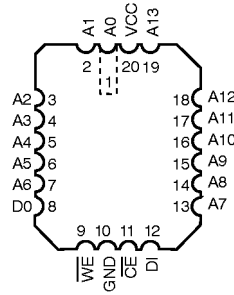

Pinout LCC 20 pins (top view)

Logic Symbol

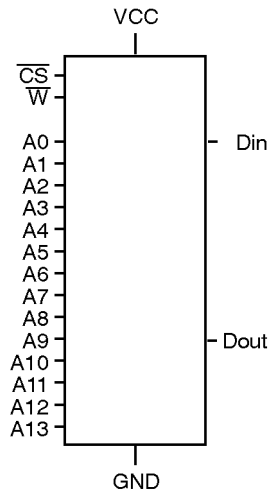

Pin Names

A0–A13: Address inputs	\overline{W} : Write enable
Din : Input	Vcc : Power
Dout : Output	GND : Ground
\overline{CS} : Chip Select	

Truth Table

\overline{CS}	\overline{W}	DATA-IN	DATA-OUT	MODE
H	X	Z	Z	Deselect
L	H	Z	Valid	Read
L	L	Valid	Z	Write

L = Low – H = High – X = H or L, Z = High impedance.

Electrical Characteristics

Absolute Maximum Ratings

Supply voltage to GND potential :	-0.5 V to +7.0 V	Storage temperature :	-65°C to +150°C
DC input voltage :	-3.0 V to +7.0 V	Output current into outputs (low) :	20 mA
DC output voltage in high Z state :	-0.5 V to +7.0 V	Electro Static Discharge Voltage	> 2000 V (MIL STD 883C 3015-2)

Operating Range

		OPERATING VOLTAGE	OPERATING TEMPERATURE
Military	(- 2)	5 V ± 10 %	- 55°C to + 125°C
Commercial	(- 5)	5 V ± 10 %	0°C to + 70°C

Recommended DC Operating Conditions

PARAMETER	DESCRIPTION	MINIMUM	TYPICAL	MAXIMUM	UNIT
Vcc	Supply Voltage	4.5	5.0	5.5	V
Gnd	Ground	0.0	0.0	0.0	V
VIL	Input low voltage	- 0.3	0.0	0.8	V
VIH	Input high voltage	2.2	-	5.5	V

Capacitance

PARAMETER	DESCRIPTION	MINIMUM	TYPICAL	MAXIMUM	UNIT
Cin (1)	Input capacitance	-	-	4	pF
Cout (1)	Output capacitance	-	-	7	pF
C CS (1)	CS capacitance	-	-	5	pF

Note : 1. TA = 25°C, f = 1 MHz, Vcc = 5.0 V.

DC Parameters

PARAMETER	DESCRIPTION	MINIMUM	TYPICAL	MAXIMUM	UNIT
IIX (2)	Input leakage current	- 10.0	-	10.0	µA
IOZ (3)	Output leakage current	- 50.0	-	50.0	µA
IOS (3)	Output short circuit current	-	-	- 350.0	mA
VOL (4)	Output low voltage	-	-	0.4	V
VOH (5)	Output high voltage	2.4	-	-	V

- Note :**
- Gnd < Vin < Vcc, Gnd < Vout < Vcc Output disabled.
 - Vcc = max, Vout = Gnd, duration of the short circuit should not exceed 30 seconds.
 - Vcc min, IOL = 12.0 mA (commercial) 8.0 mA (military).
 - Vcc min, IOH = -4.0 mA.

Consumption for Commercial (-5) Specification

SYMBOL	PARAMETER	65767B H-5	65767B K-5	65767B M-5	65767B N-5	UNIT	VALUE
ICCSB (6)	Standby supply current	20	20	20	30	mA	max
ICCOP (7)	Dynamic operating current	70	70	70	90	mA	max

Consumption for Military (-2) Specification

SYMBOL	PARAMETER	65767B H-2	65767B K-2	65767B M-2	65767B N-2	UNIT	VALUE
ICCSB (6)	Standby supply current	30	20	20	20	mA	max
ICCOP (7)	Dynamic operating current	80	70	70	70	mA	max

- Note :**
- $\overline{CS} \geq V_{IH}$, a pull-up resistor to V_{cc} on the CS input is required to keep the device deselected during V_{cc} power-up otherwise ICCSB will exceed values above.
 - V_{cc} max, Output current = 0 mA, $f = \text{max}$, $V_{in} = V_{cc}$ or Gnd.

AC Parameters

AC Conditions

Input pulse levels : Gnd to 3.0 V Input timing reference levels : 1.5 V
 Input rise : 5 ns Output loading IOL/IOH (see figure 1a) : +30 pF

AC Test Loads and Waveforms

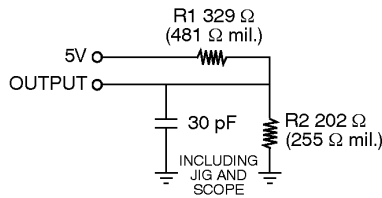

Figure 1 a

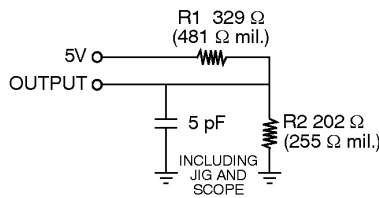

Figure 1 b

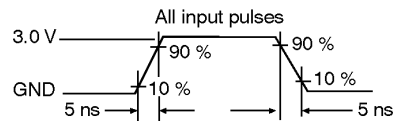
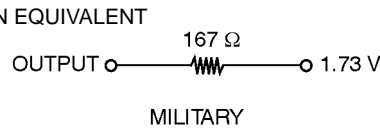
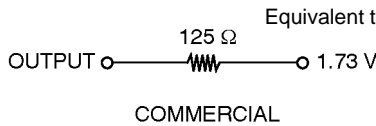

Figure 2



Write Cycle : Commercial (-5) Specification

SYMBOL	PARAMETER	65767B H-5	65767B K-5	65767B M/N-5	UNIT	VALUE
TAVAV	Write cycle time	25	30	40	ns	min
TAVWL	Address set-up time	0	0	0	ns	min
TAVWH	Address valid to end of write	25	30	40	ns	min
TDVWH (8)	Data set-up time	15	15	15	ns	min
TELWH	\overline{CS} low to write end	25	30	40	ns	min
TWLQZ(9)	Write low to high Z	25	30	20	ns	max
TWLWH	Write pulse width	15	20	20	ns	min
TWHAX	Address hold to end of write	2	2	2	ns	min
TWHDX (8)	Data hold time	0	0	0	ns	min
TWHQX	Write high to low Z	0	0	0	ns	min
TEHAX	Address hold end \overline{CS}	3	3	3	ns	min

Write Cycle : Military (-2) Specification

SYMBOL	PARAMETER	65767B H-2	65767B K-2	65767B M-2	65767B N-2	UNIT	VALUE
TAVAV	Write Cycle time	25	30	40	40	ns	min
TAVWL	Address set-up time	0	0	0	0	ns	min
TAVWH	Address valid to end of write	25	30	40	40	ns	min
TDVWH (8)	Data set-up time	15	15	15	15	ns	min
TELWH	\overline{CS} low to write end	25	30	40	40	ns	min
TWLQZ(9)	Write low to high Z	15	20	20	20	ns	max
TWLWH	Write pulse width	15	20	20	20	ns	min
TWHAX	Address hold to end of write	2	2	2	2	ns	min
TWHDX (8)	Data hold time	0	0	0	0	ns	min
TWHQX	Write high to low Z	3	0	0	0	ns	min
TEHAX	Address hold end \overline{CS}	3	3	3	3	ns	min

- Notes :**
8. The data input set up and hold timing should be referenced to the rising edge of the signal that terminates the write.
 9. TWLQZ and TEHQZ are specified with CL = 5 pF as in part (1b) of AC test loads.

Write Cycle 1 (\overline{W} Controlled)

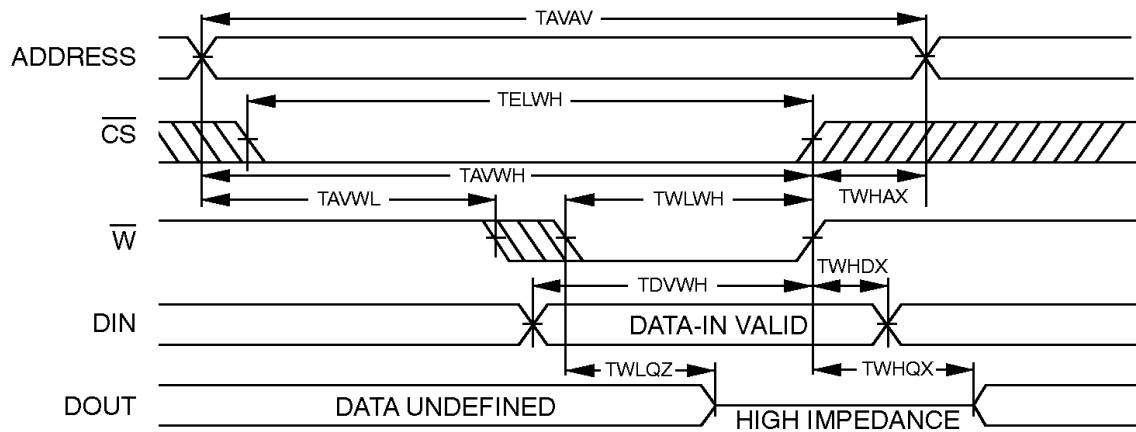

Write Cycle 2 (\overline{CS} controlled)

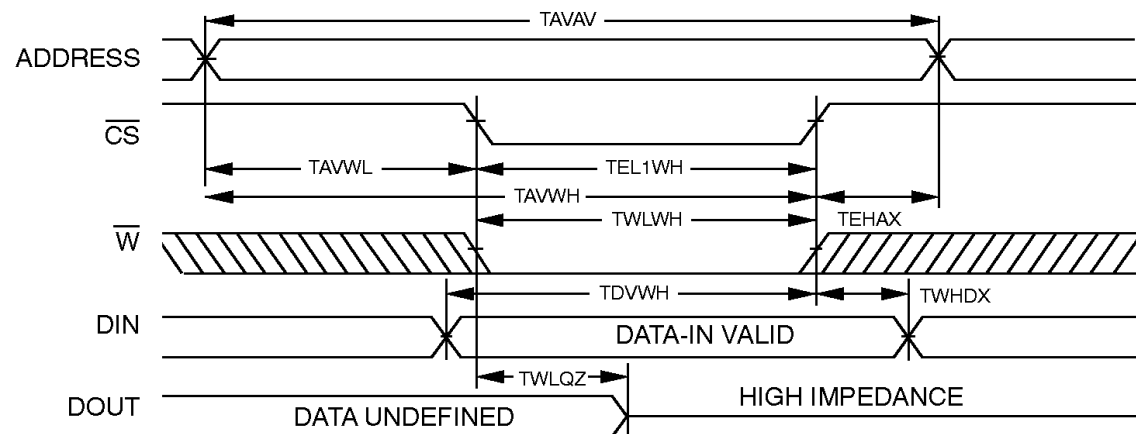

Read Cycle : Commercial (-5) Specification

SYMBOL	PARAMETER	65767B H-5	65767B K-5	65767B M-5	65767B N-5	UNIT	VALUE
TAVAV	READ cycle time	25	30	40	50	ns	min
TAVQV	Address access time	25	30	40	50	ns	max
TAVQX	Address valid to low Z	3	3	3	3	ns	min
TELQV	Chip-select access time	25	35	45	55	ns	max
TELQX	\overline{CS} low to low Z	5	5	5	5	ns	min
TEHQZ (9)	\overline{CS} high to high Z	15	20	25	25	ns	max
TELIC	\overline{CS} low to power up	0	0	0	0	ns	min
TEHICL	\overline{CS} high to power down	20	25	30	30	ns	max

Read Cycle : Military (-2) Specification

SYMBOL	PARAMETER	65767B H-2	65767B K-2	65767B M-2	65767B N-2	UNIT	VALUE
TAVAV	READ cycle time	25	35	40	50	ns	min
TAVQV	Address access time	25	35	40	50	ns	max
TAVQX	Address valid to low Z	2	3	3	3	ns	min
TELQV	Chip-select access time	25	35	45	55	ns	max
TELQX	\overline{CS} low to low Z	3	5	5	5	ns	min
TEHQZ (9)	\overline{CS} high to high Z	10	20	25	25	ns	max
TELIC	\overline{CS} low to power up	0	0	0	0	ns	min
TEHICL	\overline{CS} high to power down	20	25	30	30	ns	max

HM 65767B

Read Cycle nb 1

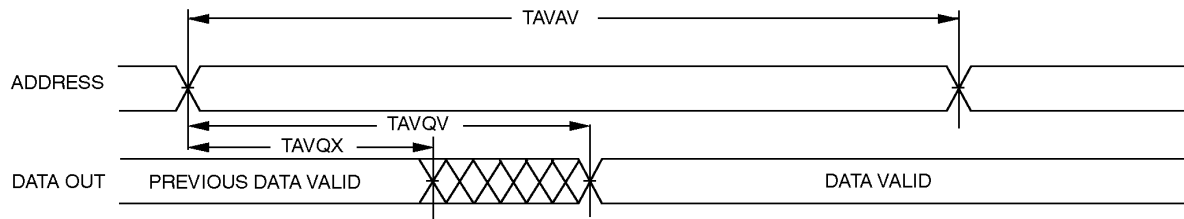

Read Cycle nb 2

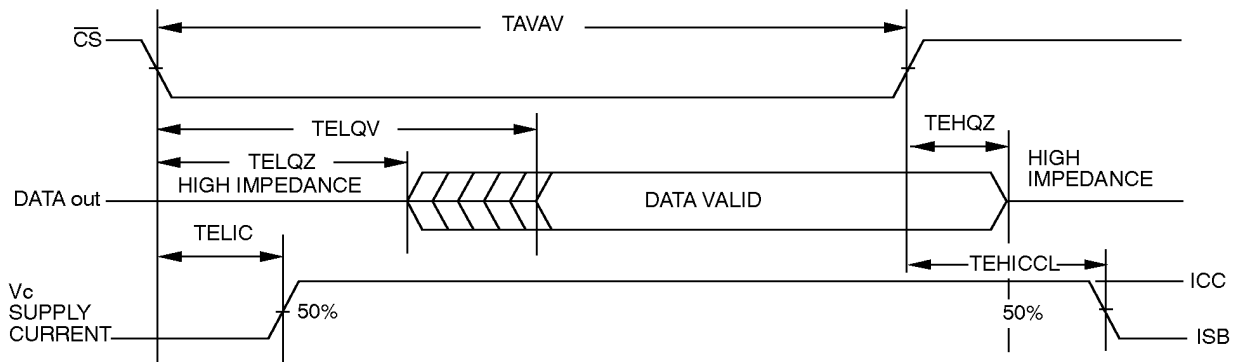

Burn-In Schematics

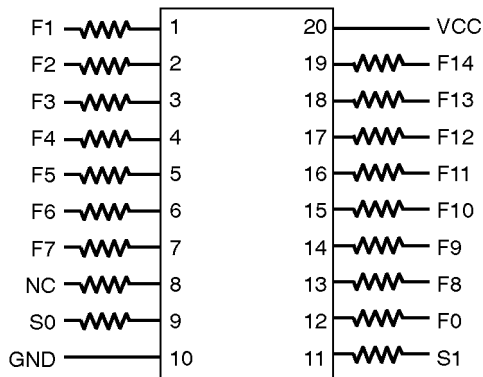

$R = 220 \Omega$ per row
 $FO = 50 \text{ KHz} \pm 20 \%$
 $F_n = 1/2 F_{n-1}$
 S0, S1 : programmable signals
 for write/read cycles
 $V_{cc} = 5.5 \text{ V}$
 NC = Not connected

Ordering Information

PACKAGE	DEVICE TYPE	GRADE	LEVEL
HM 3 0 - Chip form 1 - Ceramic 20 pins 300 mils 3 - Plastic 20 pins 300 mils 4 - LCC 20 pins rectangular T - SOIC 20 pins 300 mils	65728B 16 k × 1 high speed static RAM	H H = 25 ns K = 35 ns M = 45 ns N = 55 ns	-5 : R -2 : Military -5 : Commercial -6 : 100% 25°C Probe /883 : MIL STD 883 Class B or S DB : Dice Military program R : Tape & Reel option RD : Tape & Reel/Dry pack option D : Dry pack option

The information contained herein is subject to change without notice. No responsibility is assumed by MATRA MHS SA for using this publication and/or circuits described herein : nor for any possible infringements of patents or other rights of third parties which may result from its use.