

# Compact Manometer Series PPA

Pressure measurements can easily be taken any time, anywhere.



## ■ Compact and lightweight

Portable type with a lightweight of only about 100 g (unit 50 g, battery 50 g) can also be held in the palm of the hand.

## ■ Back light for easy viewing in dark locations

## ■ Long service life of 12 months continuous operation

One year of continuous operation is possible with 2 type AA batteries (3 V).

## ■ Convenient hand strap for carrying

Keeping practical use in mind, the hand strap is a standard feature.

## ■ Zero/span calibration is possible

Offset adjustment with the zero clear function, and span calibration with the trimmer can be performed.

## ■ Peak/Bottom hold function

With pressure being displayed, variations in supply pressure can be grasped instantly with one touch switching of the display from peak value to bottom value.

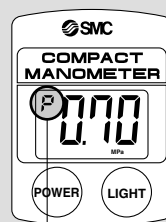

Peak display

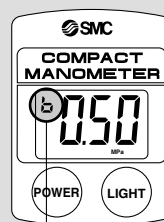

Bottom display

## ■ Auto power off function to save batteries

Power turns off automatically if not operated for more than 5 minutes.

## ■ Case holder is available

The case holder is provided as an option to allow for situations where portability is not required.

F.R.L.

AV

AU

AF

AR

IR

VEX

AMR

ITV

IC

VBA

VE□

VY1

G

PPA

AL

## Series PPA

# Pressure measurements can easily be taken any time, anywhere.

### Application Example

#### Confirmation of air line source pressure

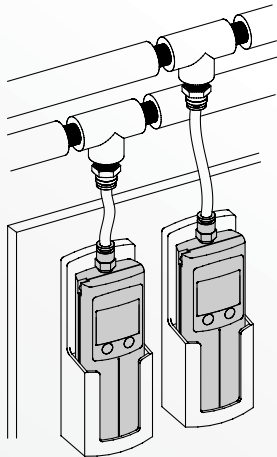

Human reading error is eliminated by the ability to confirm line pressure on the digital display. It is also possible to check pulsation in the source pressure using the peak/bottom display function.

#### Confirmation of regulator set pressure

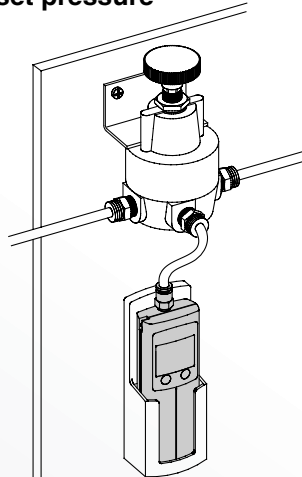

Setting a regulator can be performed more precisely than with a dial gauge by viewing the digital display while making the setting. Furthermore, power lines are not needed for this battery operated unit.



## Compact Manometer Series PPA

### Related products for line pressure measurement

Convenient for easy line pressure measurement without removing piping or stopping supply pressure, etc.

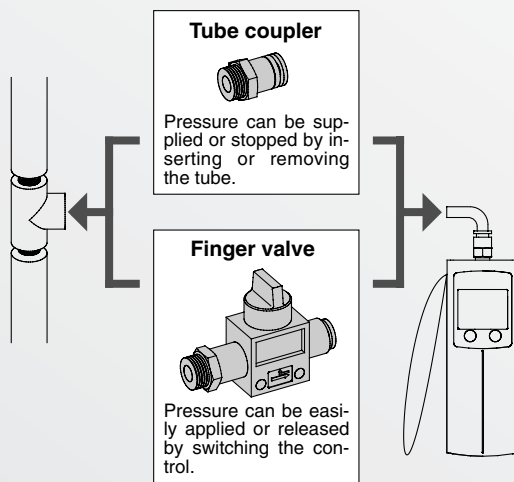

For specifications, refer to page 14-12-4.

### Can also be used as an energy saving related device

- Measures the total pressure received by an air blown workpiece



Used in combination with the pressure probe (IN-442-5), total pressure can be easily measured.

## ⚠ Precautions

Be sure to read before handling. Refer to pages 14-21-3 to 14-21-4 for Safety Instructions and Common Precautions.

### Handling

#### ⚠ Warning

1. **The compact manometer can be used for measurement of air and non-corrosive gases.**  
Please note that the accuracy of measurement for other fluids cannot be guaranteed. Furthermore, the construction is not explosion proof, and therefore, flammable gases should not be used.
2. **Be certain to stay within the rated pressure range.**  
Operation outside the pressure range will cause failure.
3. **Do not intentionally swing around by the hand strap.**  
If the strap breaks or comes loose, there is a danger of injury or damage, etc.
4. **When installing or removing One-touch fittings on tubing, first confirm that the fluid to be measured is at atmospheric pressure.**  
If tubing is disconnected while the fluid to be measured is in a pressurized state, the tubing may jump causing a danger of injury or damage. Also when connecting tubing, confirm that it is securely attached.
5. **Instruction manual**  
Read it carefully and understand the contents before using a product. Also, keep the manual in a location where it can be referred to at any time.

#### ⚠ Caution

1. **Keep condensate and foreign matter from getting into the fluid to be measured.**  
If condensate or foreign matter is mixed in the fluid to be measured, this may cause failure or air leakage.  
If there is a possibility of these being contained in the fluid, use the meter via a filter or mist separator.
2. **Do not drop or strike the unit, etc.**  
Do not drop, strike or apply a large impact shock (980 m/s<sup>2</sup>), as this may result in a failure.
3. **Be certain to perform the zero clear function with pressure released to the atmosphere.**  
When performing the zero clear function, this should be done with piping ports in an atmospheric release condition. If adjustment is performed at a pressure other than atmospheric pressure, the correct value will not be displayed.
4. **Tighten One-touch fittings in accordance with the following.**  
One-touch fittings should first be tightened by hand, and then further tightened approximately 1/6 of a turn using a tightening tool. If screwed in too far, this may cause air leakage due to breaking of threads or distortion of the gasket, etc. If not screwed in far enough, this may cause a loose fitting or air leakage, etc.

### Operating Environment

#### ⚠ Warning

1. **Absolutely never use in an atmosphere where explosive gases are used.**  
The compact manometer does not have explosion proof construction. If used in an atmosphere of explosive gases, there is a possibility of causing an explosion, and therefore, should absolutely not be used under these conditions.

#### ⚠ Caution

1. **Do not use where there is splashing of water or oil, etc.**  
The compact manometer is not a dusttight and dripproof type, and should not be used where there is splashing water or oil, etc., as this may result in a malfunction.

### Maintenance and Other

#### ⚠ Warning

1. **Perform maintenance and inspection on a regular basis.**  
If there is an unintended misaction, misoperation, etc., or calibration has not been performed, there is a possibility of an incorrect value being displayed, making it impossible to ensure safety.
2. **Do not disassemble or modify the unit.**

#### ⚠ Caution

1. **Use manganese type AA dry batteries (R6) or alkaline type AA dry batteries (LR6).**  
Do not use batteries other than the above, as this may cause failure.
2. **Insert the plus (+) and minus (-) terminals of the batteries in the proper direction as indicated inside the unit.**  
If the batteries are inserted incorrectly, this may cause them to leak or explode and result in damage to the unit.
3. **Do not use old and new batteries or mix different types of batteries together.**  
This may cause batteries to leak and result in damage to the unit.
4. **Remove the batteries when the unit will not be used for a long period.**
5. **Do not use batteries if their voltage has dropped.**  
Continuing to use them may lead to the display of incorrect values.
6. **Do not touch the span calibration trimmer except when performing span calibration.**  
Touching the trimmer may cause generation of an error in the measured pressure. Also do not turn it too hard (0.3 N·m or less) or press it too hard (5 N or less).
7. **Use a soft cloth to wipe the blot off of the body.**  
In case of heavy soiling, wipe it off with a cloth soaked in a neutral detergent diluted with water after wringing it out thoroughly, and finish up by wiping with a dry cloth.

F.R.L.

AV

AU

AF

AR

IR

VEX

AMR

ITV

IC

VBA

VE□

VY1

G

PPA

AL

# Compact Manometer

# Series PPA

## PPA100/101/102



### How to Order

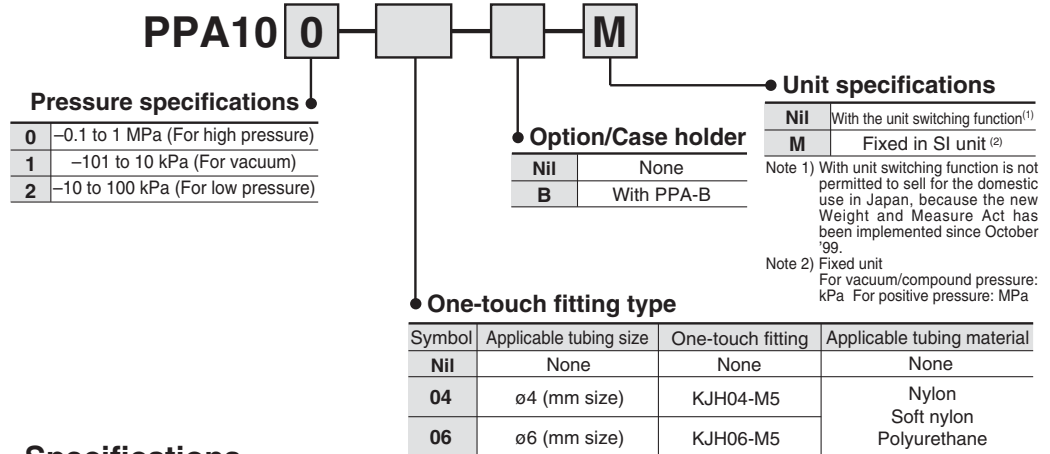

### Specifications

Model	PPA100 for high press.	PPA101 for vacuum	PPA102 for low press.
Rated pressure range	-0.1 to 1 MPa	-101 to 10 kPa	-10 to 100 kPa
Pressure display	3 digit LCD back light		
Pressure display discrimination	1/100		
Mini. display units <sup>Note)</sup>	kPa	—	1
	MPa	0.01	—
	mmHg	—	5
	kgf/cm <sup>2</sup>	0.1	0.01
	inHg	—	0.2
	PSI	1	0.1
	bar	0.1	0.01
Error display	Over pressure, Memory data error, Change battery sign		
Function	Peak/bottom display, Backlight, Auto power OFF Zero clear, Units display switching		
Withstanding pressure	1.5 MPa	200 kPa	200 kPa
Fluid	Air, Non-corrosive gases		
Power supply	3 V (DC), Type AA dry cell x 2 pcs.		
Battery life	12 months continuous operation (Without backlighting, temperature conditions: at 25°C)		
Response speed	250 ms		
Display accuracy	±2% F.S. or less (Temperature conditions: at 25°C)		
Repeatability	±1% F.S. or less (Temperature conditions: at 25°C)		
Temperature characteristics	±3% F.S. or less (0 to 50°C with 25°C standard)		
Piping port	M5 x 0.8		
Ambient operating temperature	0 to 50°C (With no condensation)		
Ambient operating humidity	35 to 85% RH (With no condensation)		
Shock resistance	980 m/s <sup>2</sup> X, Y, Z directions, 3 times each		
Enclosure	IP40 (IEC standard)		
Weight	Approx. 100 g (Unit 50 g, batteries 50 g)		

\* 2 pcs. of type AA dry batteries (manganese R6 or alkaline LR6) are not included.

Note) For the unit switching function (Types without the unit switching function is fixed in SI unit (kPa or MPa).)

## Description of Operating Parts

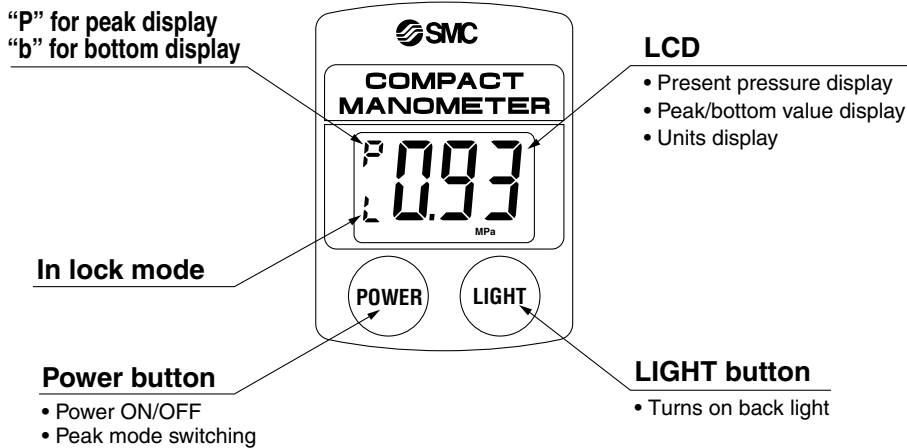

## Operation and Functions

(PPA100 shown, Unit: MPa)

### Initial Setting

Be certain to perform initial setting when using for the first time and after changing batteries, as the unit will indicate memory data error.

#### 1. Confirmation of display

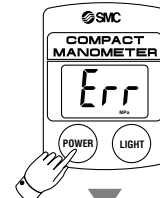

#### 2. Press and hold the POWER button for 6 seconds or more.

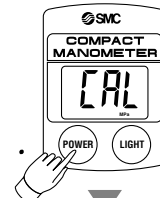

#### 3. Release the POWER button.



- When the power is applied, and "Err" is displayed on LED, cut the power off for a time. After turning OFF (i.e. the state in which nothing is displayed on LCD), then proceed to 2. Besides, in the case that nothing is displayed on LCD, proceed to 2 with doing nothing.
- Press and hold for 6 seconds or more. The unit will go into zero clear. When this happens "CAL" will appear on the LCD.
- When zero clear is finished, the unit can be operated.

### Power ON

Press the POWER button.



- The power comes ON as it is pressed.
- When pressed and held for 6 seconds or more, the unit goes into zero clear.

### Power OFF

Press and hold the POWER button for 3 seconds or more.

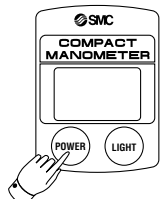

- When pressed and held for 3 seconds or more, the power turns OFF.
- When there is no button operation for more than 5 minutes, the power turns OFF. (auto power OFF function)

F.R.L.

AV

AU

AF

AR

IR

VEX

AMR

ITV

IC

VBA

VE□

VY1

G

PPA

AL

# Series PPA

## Operation and Functions

(PPA100 shown, Unit: MPa)

### Unit Display Switching

**Note)** This operation cannot be done for the type which does not have the unit switching function.

1. Press and hold the **POWER** and **LIGHT** buttons for 3 seconds or more.

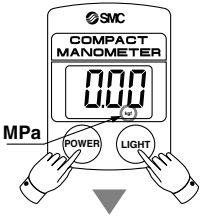

2. Press the **LIGHT** button.

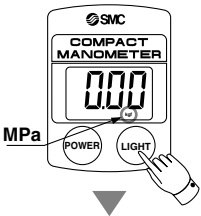

3. Press the **POWER** button.

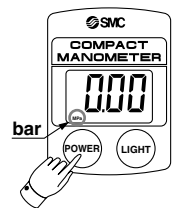

1. When pressed continuously for 3 seconds or more, the unit on the LCD will flash.
2. The unit will change. (See the table below.)
3. The unit is set, and switching is finished.

High pressure (PPA100)	Vacuum (PPA101)	Low pressure (PPA102)
MPa → bar → PSI → kgf	kPa → bar → PSI → inHg → mmHg	kPa → bar → PSI → kgf

**Note)** The "inHg" unit cannot be displayed.

### Auto Power OFF Function

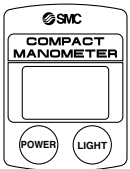

When the power is turned ON and there is no button operation for more than 5 minutes, the power will turn OFF.

**Note)** For cancelling this function, refer to the functions and operation of the lock mode (below).

### Lock Mode (Auto power OFF cancel)

Press and hold the **POWER** and **LIGHT** buttons for 6 seconds or more.

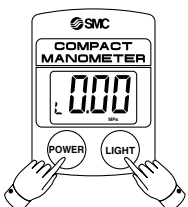

The auto power OFF function is canceled by activating the lock mode (auto power OFF cancel).

When continuously pressed for 6 seconds or more, "L" is displayed on the LCD. Moreover, when the power is turned OFF, the lock mode is released.

### Peak/Bottom Display

**Note)** Since this is combined with power OFF operation, the button should be released at the point when "P" or "b" is displayed.

Press the **POWER** button.



Press the **POWER** button.

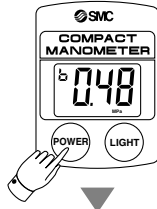

Press the **POWER** button.



Do this when pressure is being displayed.

#### Peak display

Displays the maximum pressure value and "P" appears on the LCD. The display will change if pressure increases beyond the pressure value that is being held.

#### Bottom display

Displays the minimum pressure value and "b" appears on the LCD. The display will change if pressure falls below the pressure value that is being held.

(These modes are convenient for confirming pressure fluctuations.)

### Turning on the Backlight

Press the **LIGHT** button.

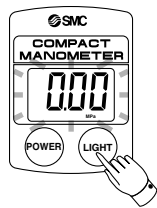

It normally lights up while the button is being pressed. In the lock mode, it lights up when pressed and turns off when pressed again. However, the maximum lighting time is approximately one minute.

### Zero Clear

Press the **POWER** button for 6 seconds or more.



The zero point displayed at atmospheric pressure can be automatically adjusted. By this means it is possible to eliminate a display discrepancy at atmospheric pressure.

- Turn the power OFF.
- Release the supply pressure to the atmosphere.
- When continuously pressed for 6 seconds or more, zero clear is performed and "CAL" is displayed on the LCD.

# Compact Manometer Series PPA

## Dimensions

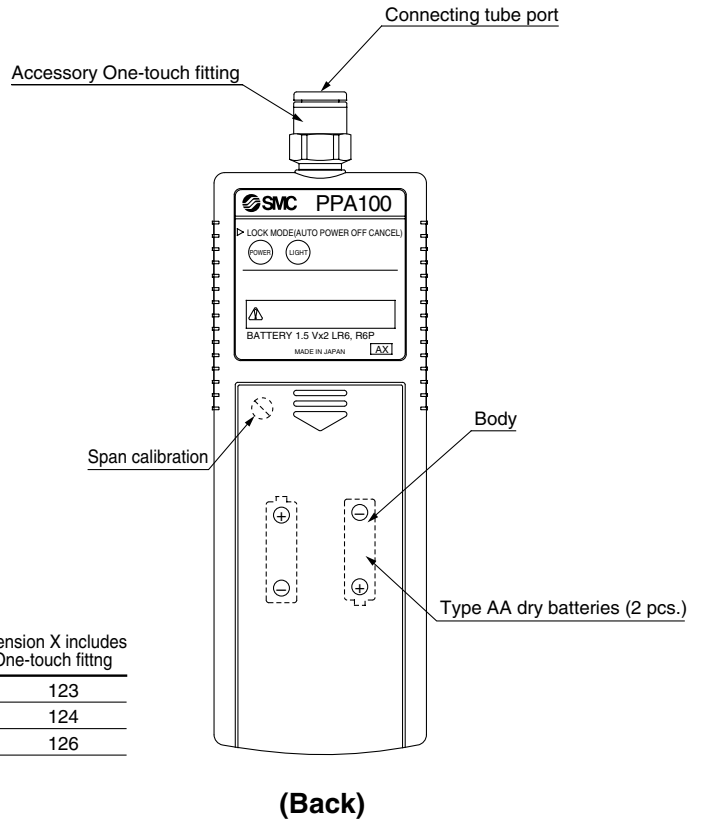
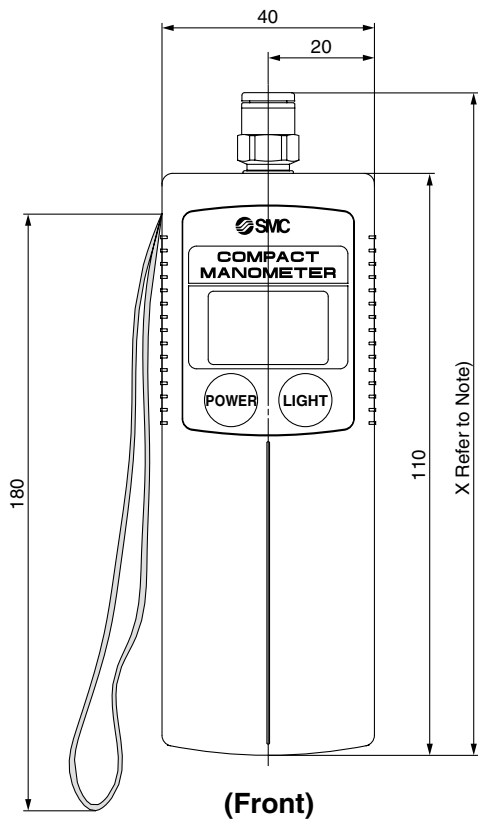

Note) Dimension X includes the One-touch fitting

ø4	123
ø6	124
ø1/4"	126

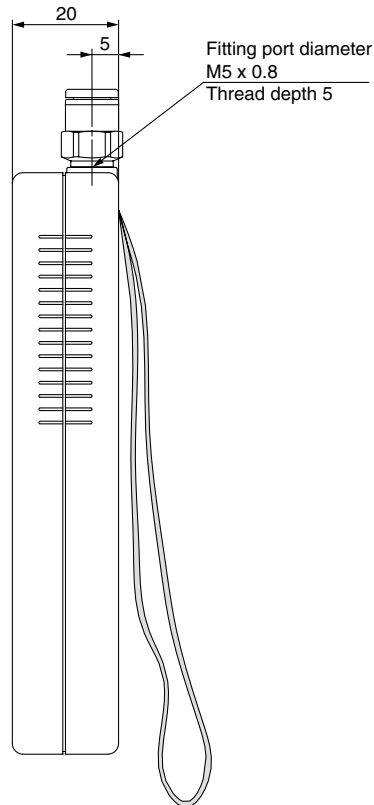

### Option/Case holder

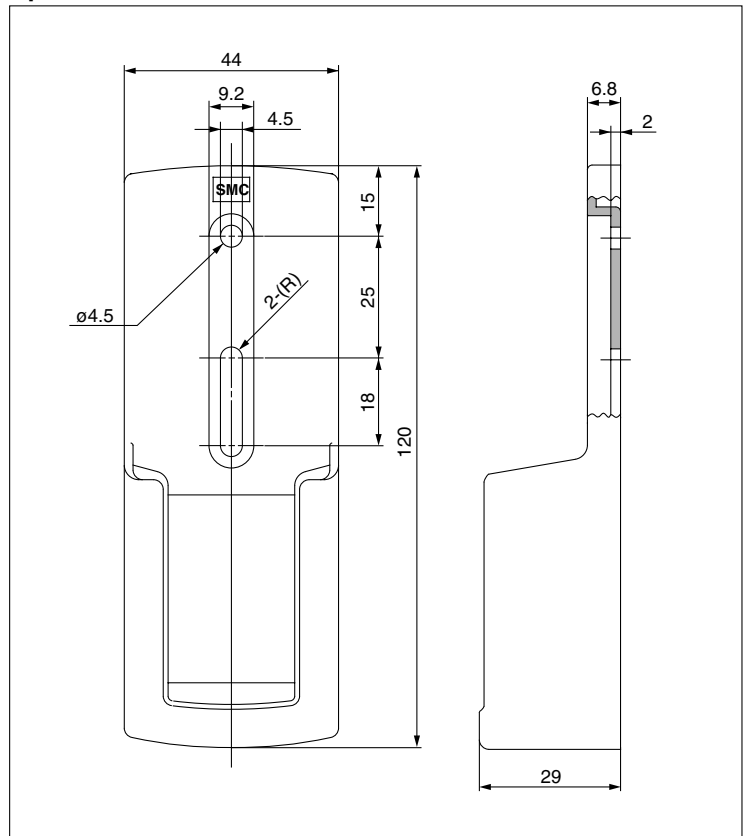

- F.R.L.
- AV
- AU
- AF
- AR
- IR
- VEX
- AMR
- ITV
- IC
- VBA
- VE□
- VY1
- G
- PPA
- AL

# Series PPA

## Error Correction

When errors occur, they should be corrected as shown below.

Display	Contents	Corrective action
---	Pressure being applied is above the rating.	Operate within the rated pressure range.
Err	Memory data has probably been corrupted in some way.	Perform auto zero adjustment.
Entire display flashes	Battery voltage is low.	Replace the batteries.

## Maintenance

### Span calibration method

#### Caution

**Do not touch the span calibration trimmer except when performing span calibration.**

1. Perform zero clear at atmospheric pressure.
2. Apply the maximum rated pressure, and calibrate the span while comparing with a standard pressure gauge.
3. If the display value of the compact manometer is "0" after returning to atmospheric pressure, then calibration is complete. If the display value is not "0", calibrate again by repeating steps 1 and 2.

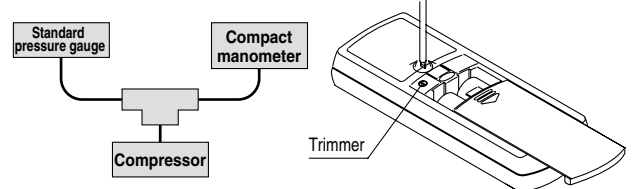

### Replacing the batteries

When battery voltage becomes low the entire LCD will flash. When the LCD flashes replace the batteries. Use 2 pcs. of type AA dry batteries.

#### Caution

**To replace the batteries, turn the power OFF and replace them within approximately 30 seconds.**

**When not completed within 30 seconds, "Err" will be displayed. In that case, perform zero clear once again.**

In the event that the display runs out of control, remove the batteries for one minute or longer, and then perform zero clear again for inserting the batteries and turning on the power.

## Related Products Useful for Measuring Line Pressure

These products are convenient for measuring line pressure easily without the need to remove piping or stop supply pressure, etc.

Switching between pressurization and atmospheric release can be easily performed by switching the control.

Finger valve

Series VHK



### Specifications

Valve type	2 port valve, 3 port valve
Fluid	Air
Proof pressure	1.5 MPa
Maximum operating pressure	1.0 MPa
Operating vacuum pressure*	-100 kPa
Ambient and fluid temperature	0 to 60°C
Applicable tubing material <sup>(Note)</sup>	Nylon, Soft nylon, Polyurethane
Option	Bracket

Note) Use caution with soft nylon and polyurethane at the maximum operating pressure. (For details, refer to Best Pneumatics Vol. 15.)

\* For a vacuum application, use VHK2 (2 way valve).

### JIS Symbol

2 port valve

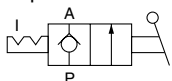

3 port valve

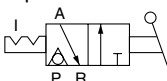

For details, refer to Best Pneumatics Vol. 15.

Pressure can be supplied or stopped by inserting or removing a tube.

Self-seal fittings

Series KC



### Applicable Tubing

Tubing material	Nylon, Soft nylon, Polyurethane
Tubing O.D.	ø4, ø6, ø8, ø10, ø12

### Specifications

Fluid	Air	
Maximum operating pressure	1.0 MPa	
Proof pressure	3.0 MPa	
Ambient and fluid temperature	0 to 60°C	
Thread	Mounting section	JIS B 0203 (Taper threads for piping)
	Nut section	JIS B 0211 Class 2 (Metric fine thread)
Seal (Thread portion)	With seal (Standard)	
Adaptor for copper family incompatible parts	Part C3604BD (Electroless nickel plated)	

### Principal Parts Material

Body	C3604BD, PBT
Stud	C3604BD (Thread portion)
Chuck spring	Stainless steel 304
Guide	C3604BD, Polyacetal (POM)
Collet release bushing	POM
Valve retainer	POM
Stopper	C3604BD, Polyacetal (POM)
Seal O-ring	NBR

For details, refer to Best Pneumatics Vol. 15.