

Solid State Relays Industrial, 1-Phase ZS (IO) w. LED and Built-in Varistor Types RM 23, RM 40, RM 48, RM 60



- Zero switching (RM1A) or instant-on switching (RM1B) AC Solid State Relay
- Direct copper bonding (DCB) technology
- LED indication
- Built-in varistor
- Clip-on IP 20 protection cover
- Self-lifting terminals
- Housing free of moulding mass
- 2 input ranges: 3-32* VDC and 20-280VAC/22-48VDC
- Operational ratings: Up to 100AACrms and 600VACrms
- Blocking voltage: Up to 1400V_p
- Opto-isolation: > 4000VACrms



Product Description

The industrial, 1-phase relay with antiparallel thyristor output is the most widely used industrial SSR due to its multiple application possibilities. The relay can be used for resistive, inductive and capacitive loads. The zero switching relay switches ON when the sinusoidal curve crosses zero and switches OFF when the current crosses zero.

The instant-on relay with DC control input can be used for phase control. The built-in varistor secures transient protection for the heavy industrial applications, and the LED indicates the status of the control input. The clip-on cover is securing touch protection to IP 20. Protected output terminals can handle cables up to 16mm².

Ordering Key

RM 1 A 23 D 25

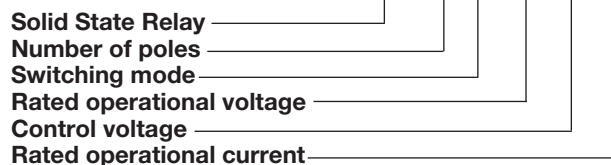

Type Selection

Switching mode	Rated operational voltage	Control voltage	Rated operational current
A: Zero Switching (ZC) B: Instant-on switching (IO)	23: 230VACrms 40: 400VACrms 48: 480VACrms 60: 600VACrms	A: 20-280VAC / 22-48VDC D: 3-32VDC* <small>*4 to 32VDC for 400, 480 and 600VAC types *4 to 32VDC for RM1B types</small>	25: 25AACrms 50: 50AACrms 75: 75AACrms 100: 100AACrms

Selection Guide

Rated operational voltage, Switching mode	Blocking voltage	Control voltage	Rated operational current with suitable heatsink			
			25A	50A	75A	100A
230VACrms, ZC	650V _p	3 - 32VDC	RM1A23D25	RM1A23D50	RM1A23D75	RM1A23D100
		20 to 280VAC 22 to 48VDC	RM1A23A25	RM1A23A50	RM1A23A75	RM1A23A100
400VACrms, ZC	800V _p	4 - 32VDC	RM1A40D25	RM1A40D50	RM1A40D75	RM1A40D100
		20 to 280VAC 22 to 48VDC	RM1A40A25	RM1A40A50	RM1A40A75	RM1A40A100
480VACrms, ZC	1200V _p	4 - 32VDC	RM1A48D25	RM1A48D50	RM1A48D75	RM1A48D100
		20 to 280 VAC 22 to 48VDC	RM1A48A25	RM1A48A50	RM1A48A75	RM1A48A100
600VACrms, ZC	1400V _p	4 - 32VDC	RM1A60D25	RM1A60D50	RM1A60D75	RM1A60D100
		20 to 280VAC 22 to 48VDC	RM1A60A25	RM1A60A50	RM1A60A75	RM1A60A100

Selection Guide

Rated operational voltage, Switching mode	Blocking voltage	Control voltage	Rated operational current with suitable heatsink			
			25A	50A	75A	100A
230VACrms, IO	650V _p	4 - 32VDC	RM1B23D25	RM1B23D50	RM1B23D75	RM1B23D100
		20 - 280VAC/ 22 - 48VDC	RM1B23A50	RM1B23A50	RM1B23A75	RM1B23A100
400VACrms, IO	800V _p	4 - 32VDC	RM1B40D25	RM1B40D50	RM1B40D75	RM1B40D100
480VACrms, IO	1200V _p	4 - 32VDC	RM1B48D25	RM1B48D50	RM1B48D75	RM1B48D100
600VACrms, IO	1400V _p	4 - 32VDC	RM1B60D25	RM1B60D50	RM1B60D75	RM1B60D100
		20 - 280VAC/ 22 - 48VDC	RM1B60A25	RM1B60A50	RM1B60A75	RM1B60A100

Note: For AC control, IO switching part numbers will be created on request

General Specifications

	RM1.23...	RM1.40...	RM1.48...	RM1.60...
Operational voltage range				
RM1A...	24 to 265VACrms	42 to 440VACrms	42 to 530VACrms	42 to 660VACrms
RM1B...	42 to 265VACrms	42 to 440VACrms	42 to 530VACrms	42 to 660VACrms
Blocking voltage	650V _p	800V _p	1200V _p	1400V _p
Zero voltage turn-on	≤ 10V	≤ 10V	≤ 10V	≤ 10V
Operational frequency range	45 to 65Hz	45 to 65Hz	45 to 65Hz	45 to 65Hz
Power factor	> 0.5 @ 230VACrms	> 0.5 @ 400VACrms	> 0.5 @ 480VACrms	> 0.5 @ 600VACrms
Approvals	UR, cUR, CSA, CCC, EAC	UR, cUR, CSA, CCC, EAC	UR, cUR, CSA, CCC, EAC	UR, cUR, CSA, CCC, EAC
CE-marking	Yes	Yes	Yes	Yes *
Isolation				
Input to Output	4000 Vrms	4000 Vrms	4000 Vrms	4000 Vrms
input and Output to case	4000 Vrms	4000 Vrms	4000 Vrms	4000 Vrms

* Heatsink must be connected to ground

Input Specifications

	RM1...D..	RM1...A..
Control voltage range		
RM1A23...	3 - 32VDC	20 - 280VAC, 22 - 48VDC
RM1A40... RM1A48... RM1A60...	4 - 32VDC	20 - 280VAC, 22 - 48VDC
RM1B...	4 - 32VDC	20 - 280VAC, 22 - 48VDC
Pick-up voltage @ Ta = 25°C		
RM1A23...	2.5VDC	18VAC/DC
RM1A40... RM1A48... RM1A60...	3.5VDC	18VAC/DC
RM1B ...	3.5VDC	18VAC/DC
Reverse voltage	32VDC	-
Drop out voltage	1.2VDC	6VAC/DC
Input current @ max input voltage		
RM1A	≤12 mA	≤ 20mA
RM1B	≤15 mA	≤ 20mA
Response time pick-up		
RM1A	≤1/2 cycle	≤ 12ms
RM1B	≤0.1ms	≤ 12ms
Response time drop-out		
RM1A	≤1/2 cycle	≤ 40ms
RM1B	≤1/2 cycle	≤ 40ms

Output Specifications

	RM1...25	RM...50	RM1...75	RM1...100
Rated operational current AC51 @ Ta=25°C AC53a @ Ta=25°C	25Arms 5Arms	50Arms 15Arms	75Arms 20Arms	100Arms 30Arms
Min. operational current	150mA	250mA	400mA	500mA
Rep. overload current t=1 s	< 55AACrms	< 125AACrms	< 150AACrms	< 200AACrms
Non-rep. surge current t=10 ms	325A _p	600A _p	1150A _p	1900A _p
Off-state leakage current @ rated voltage and frequency	< 3mArms	< 3mArms	< 3mArms	< 3mArms
I²t for fusing t=10 ms	< 525A ² s	< 1800A ² s	< 6600A ² s	<18000A ² s
Critical dV/dt off-state min.	1000V/μs	1000V/μs	1000V/μs	1000V/μs
Endurance testing acc. to UL508	100,000 cycles	100,000 cycles	100,000 cycles	6,000 cycles

Note: UL requirement for General Use Endurance testing is 6,000 cycles

Motor Ratings*: HP (UL508)

	230VAC	400VAC	480VAC	600VAC
RM1..25	1.5HP	3HP	3HP	5HP
RM1..50	3HP	5HP	7.5HP	10HP
RM1..75	5HP	10HP	10HP	15HP
RM1..100	7.5HP	15HP	20HP	25HP

* with suitable heatsink

Electromagnetic Compatibility

EMC Immunity	EN60947-4-3	Radiated Radio Frequency Immunity	IEC/EN 61000-4-3
Electrostatic Discharge (ESD) Immunity Air discharge, 8kV Contact, 4kV	IEC/EN 61000-4-2 Performance Criteria 2 Performance Criteria 2	10V/m, 80 - 1000 MHz 10V/m, 1.4 - 2.0GHz 3 V/m, 2.0 - 2.7GHz	Performance Criteria 1 Performance Criteria 1 Performance Criteria 1
Electrical Fast Transient (Burst) Immunity Output: 2kV, 5kHz Input: 1kV, 5kHz	IEC/EN 61000-4-4 Performance Criteria 1 Performance Criteria 1	Conducted Radio Frequency Immunity 10V/m, 0.15 - 80 MHz	IEC/EN 61000-4-6 Performance Criteria 1
Electrical Surge Immunity Output, line to line, 1kV Output, line to earth, 2kV Input, line to line, 1kV Input, line to earth, 2kV	IEC/EN 61000-4-5 Performance Criteria 2 Performance Criteria 2 Performance Criteria 2 Performance Criteria 2	Voltage Dips Immunity 0% for 0.5, 1 cycle 40% for 10 cycles 70% for 25 cycles 80% for 250 cycles	IEC/EN 61000-4-11 Performance Criteria 2 Performance Criteria 2 Performance Criteria 2 Performance Criteria 2
EMC Emission	EN60947-4-3	Voltage Interruptions Immunity 0% for 5000ms	IEC/EN 61000-4-11 Performance Criteria 2
Radio Interference Voltage Emission (Conducted) 0.15 - 30MHz	IEC/EN 55011 Class A (industrial) with external filters	Radio Interference Field Emission (Radiated) 30 - 1000MHz	IEC/EN 55011 Class B

Notes:

- Control input lines must be installed together to maintain products' susceptibility to Radio Frequency interference.
- Performance Criteria 1: No degradation of performance or loss of function is allowed when the product is operated as intended.
- Performance Criteria 2: During the test, degradation of performance or partial loss of function is allowed. However, when the test is complete the product should return operating as intended by itself.
- Performance Criteria 3: Temporary loss of function is allowed, provided the function can be restored by manual operation of the controls.
- Use of AC solid state relays may, according to the application and the load current, cause conducted radio interferences. Use of mains filters may be necessary for cases where the user must meet E.M.C requirements.





Thermal Specifications

	RM1...25	RM1...50	RM1.60.50	RM1...75	RM1...100
Operating temperature range	-20° to 70°C	-20° to 70°C	-20° to 70°C	-20° to 70°C	-20° to 70°C
Storage temperature range	-40° to 100°C	-40° to 100°C	-40° to 100°C	-40° to 100°C	-40° to 100°C
Junction temperature	≤ 125°C	≤ 125°C	≤ 125°C	≤ 125°C	≤ 125°C
R _{th} junction to case	≤ 0.80°C/W	≤ 0.50°C/W	≤ 0.72°C/W	≤ 0.35°C/W	≤ 0.30°C/W
R _{th} junction to ambient	≤ 20.0°C/W	≤ 20.0°C/W	≤ 20.0°C/W	≤ 20.0°C/W	≤ 20.0°C/W

Housing Specifications

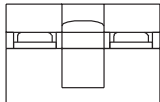
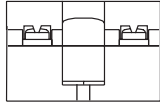
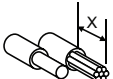
Weight 25A, 50A 75A, 100A	Approx. 60g Approx. 100g	Relay Mounting screws Mounting torque	M5 1.5-2.0Nm
Baseplate 25A, 50A 75A, 100A	Aluminium Copper, nickel-plated		
Potting compound	None		

Connection Specifications

Connection terminals	L1, T1	A1, A2			
					
Stripping length (X)	12 mm	8 mm			
Connection Type	M5 screw with captivated washer	M3 screw with captivated washer			
Rigid (solid & stranded) UR rated data		1x 2.5 - 6.0 mm ² 1x 14 - 10 AWG	2x 2.5 - 6.0 mm ² 2x 14 - 10 AWG	1x 0.5 - 2.5 mm ² 1x 18 - 12 AWG	2x 0.5 - 2.5 mm ² 2x 18 - 12 AWG
Flexible with end sleeve		1x 1.0 - 4.0 mm ² 1x 18 - 12 AWG	2x 1.0 - 2.5 mm ² 2x 2.5 - 4.0 mm ² 2x 18 - 14 AWG 2x 14 - 12 AWG	1x 0.5 - 2.5 mm ² 1x 18 - 12 AWG	2x 0.5 - 2.5 mm ² 2x 18 - 12 AWG
Flexible without end sleeve		1x 1.0 - 6.0 mm ² 1x 18 - 10 AWG	2x 1.0 - 2.5 mm ² 2x 2.5 - 6.0 mm ² 2x 18 - 14 AWG 2x 14 - 10 AWG		
Torque specification		Pozidrive 2 2.4 Nm (21.2 lb-in)	Pozidrive 1 0.5 Nm (4.4 lb-in)		
Aperture for termination lug		12 mm	7.5 mm		

Functional Diagram

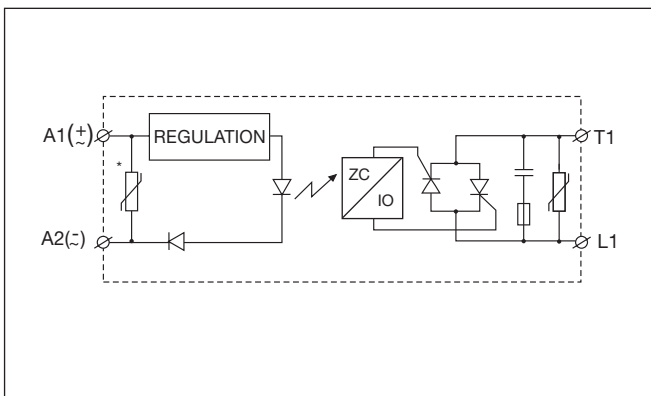

* Varistor across input applies to AC control versions only.

Dimensions

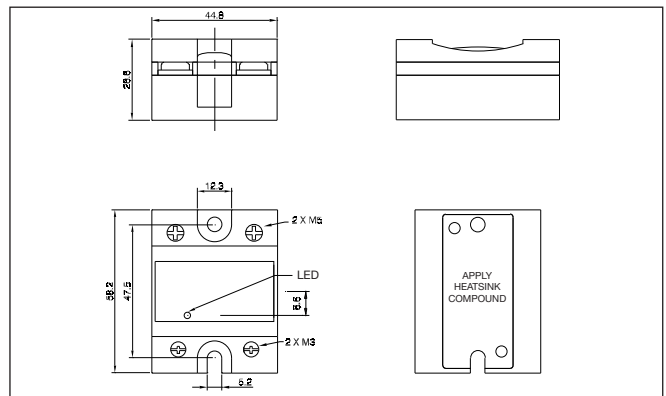

All dimensions in mm

Connection Diagram

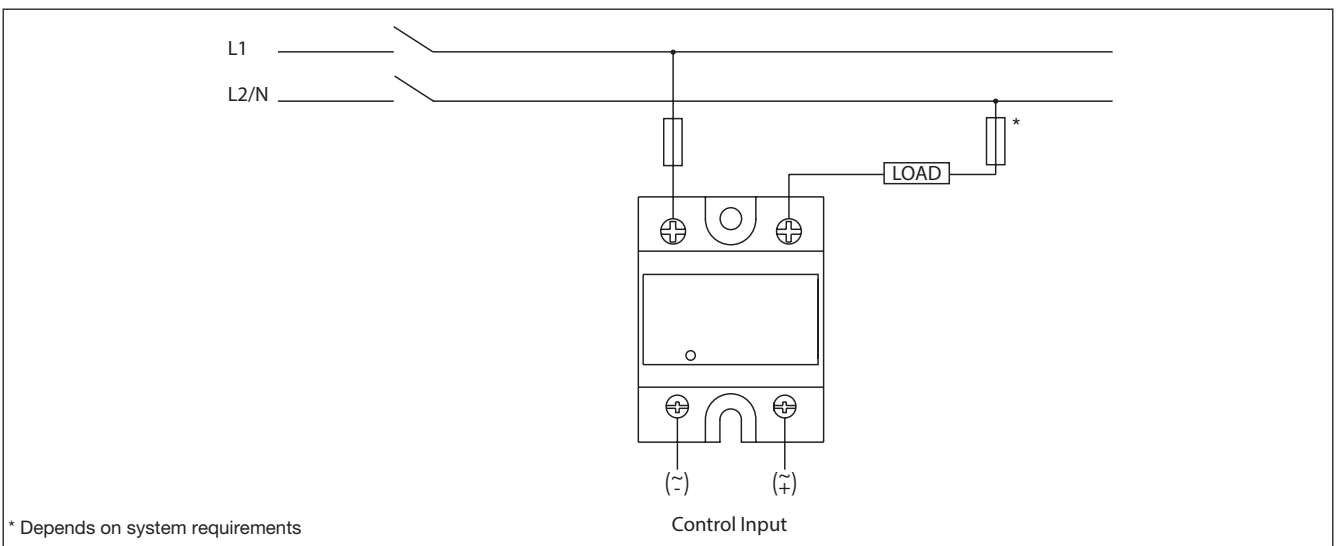

* Depends on system requirements

Output Power Dissipation

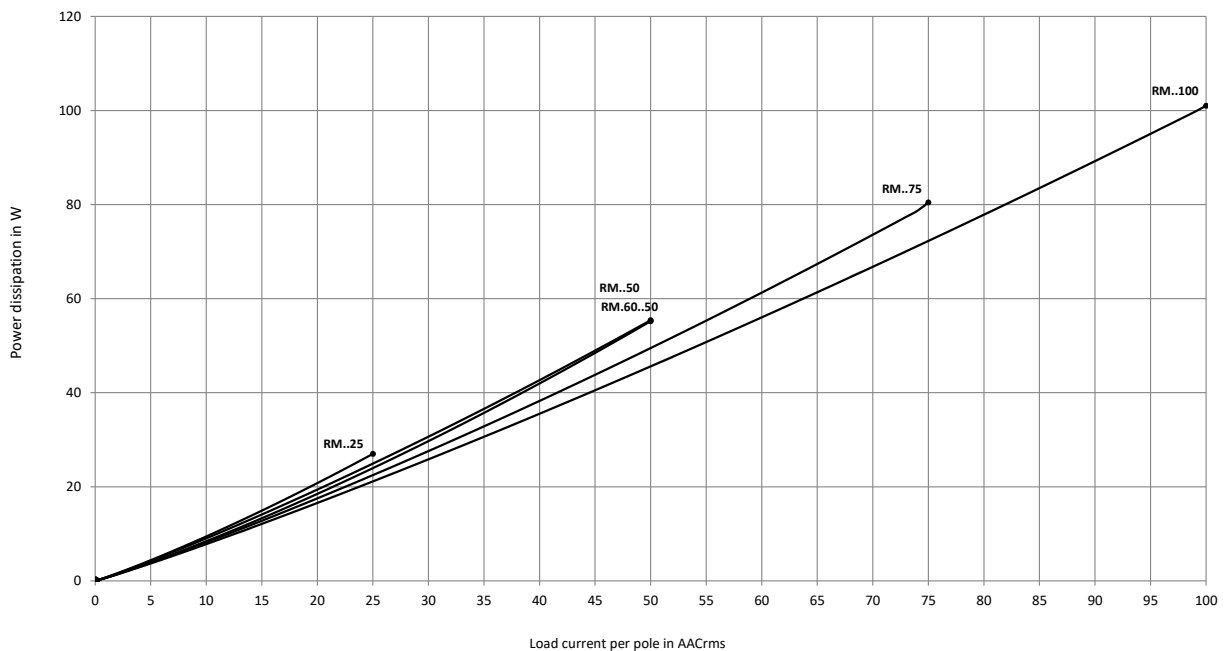

Heatsink Dimensions (load current versus ambient temperature)

RM..25

Load current [A]	Thermal resistance [°C/W]					
	20	30	40	50	60	70
25.0	2.70	2.34	1.98	1.61	1.25	0.89
22.5	3.10	2.69	2.28	1.86	1.45	1.04
20.0	3.61	3.13	2.65	2.18	1.70	1.23
17.5	4.26	3.70	3.14	2.59	2.03	1.47
15.0	5.14	4.47	3.80	3.14	2.47	1.80
12.5	6.38	5.56	4.73	3.91	3.09	2.27
10.0	8.25	7.19	6.14	5.08	4.02	2.97
7.5	11.4	9.94	8.49	7.04	5.59	4.14
5.0	17.7	15.4	13.2	11.0	8.74	6.51
2.5	-	-	-	-	18.2	13.6

RM..50

Load current [A]	Thermal resistance [°C/W]					
	20	30	40	50	60	70
50.0	1.03	0.86	0.70	0.53	0.37	0.20
45.0	1.27	1.32	0.90	0.71	0.52	0.33
40.0	1.54	1.59	1.10	0.89	0.67	0.45
35.0	1.85	1.95	1.34	1.08	0.82	0.57
30.0	2.26	2.47	1.65	1.34	1.03	0.72
25.0	2.85	3.24	2.08	1.70	1.32	0.94
20.0	3.73	3.24	2.75	2.26	1.77	1.27
15.0	5.22	4.54	3.86	3.19	2.51	1.83
10.0	8.21	7.16	6.11	5.05	4.00	2.95
5.0	17.2	15.0	12.9	10.7	8.51	6.33

Junction to ambient thermal resistance, $R_{th\ j-a}$	< 20.0	°C/W
Junction to case thermal resistance, $R_{th\ j-c}$	< 0.80	°C/W
Case to heatsink thermal resistance, $R_{th\ c-s^2}$	< 0.20	°C/W
Maximum allowable case temperature	100	°C
Maximum allowable junction temperature	125	°C

Junction to ambient thermal resistance, $R_{th\ j-a}$	< 20.0	°C/W
Junction to case thermal resistance, $R_{th\ j-c}$	< 0.50	°C/W
Case to heatsink thermal resistance, $R_{th\ c-s^2}$	< 0.20	°C/W
Maximum allowable case temperature	100	°C
Maximum allowable junction temperature	125	°C

RM1.60..50

Load current [A]	Thermal resistance [°C/W]					
	20	30	40	50	60	70
50.0	0.99	0.81	0.63	0.44	0.26	0.08
45.0	1.28	1.07	0.86	0.65	0.44	0.23
40.0	1.64	1.40	1.15	0.91	0.67	0.42
35.0	2.11	1.82	1.54	1.25	0.96	0.67
30.0	2.60	2.25	1.90	1.55	1.20	0.85
25.0	3.30	2.86	2.43	1.99	1.55	1.11
20.0	4.36	3.79	3.22	2.65	2.08	1.51
15.0	6.1	5.4	4.6	3.77	2.97	2.18
10.0	9.76	8.52	7.3	6.0	4.8	3.54
5.0	--	--	15.47	12.85	10.24	7.6

RM..75

Load current [A]	Thermal resistance [°C/W]					
	20	30	40	50	60	70
75.0	0.91	0.78	0.65	0.52	0.39	0.26
67.5	1.10	0.96	0.81	0.66	0.51	0.36
60.0	1.34	1.17	1.00	0.83	0.66	0.49
52.5	1.60	1.40	1.20	1.00	0.80	0.60
45.0	1.93	1.68	1.44	1.20	0.96	0.72
37.5	2.38	2.08	1.78	1.49	1.19	0.89
30.0	3.06	2.68	2.30	1.91	1.53	1.15
22.5	4.21	3.68	3.16	2.63	2.10	1.58
15.0	6.51	5.70	4.88	4.07	3.26	2.44
7.5	13.5	11.77	10.09	8.41	6.73	5.04

Junction to ambient thermal resistance, $R_{th\ j-a}$	< 20.0	°C/W
Junction to case thermal resistance, $R_{th\ j-c}$	< 0.72	°C/W
Case to heatsink thermal resistance, $R_{th\ c-s^2}$	< 0.10	°C/W
Maximum allowable heatsink temperature	100	°C
Maximum allowable junction temperature	125	°C

Junction to ambient thermal resistance, $R_{th\ j-a}$	< 20.0	°C/W
Junction to case thermal resistance, $R_{th\ j-c}$	< 0.35	°C/W
Case to heatsink thermal resistance, $R_{th\ c-s^2}$	< 0.10	°C/W
Maximum allowable heatsink temperature	100	°C
Maximum allowable junction temperature	125	°C

Heatsink Dimensions (load current versus ambient temperature) (cont.)

RM..100

Load current [A]	Thermal resistance [°C/W]					
	20	30	40	50	60	70
100.0	0.54	0.45	0.36	0.27	0.18	0.09
90.0	0.68	0.58	0.47	0.37	0.27	0.17
80.0	0.86	0.74	0.62	0.50	0.38	0.26
70.0	1.08	0.94	0.80	0.66	0.52	0.38
60.0	1.37	1.20	1.03	0.85	0.68	0.51
50.0	1.70	1.49	1.28	1.06	0.85	0.64
40.0	2.21	1.93	1.66	1.38	1.10	0.83
30.0	3.06	2.68	2.30	1.91	1.53	1.15
20.0	4.78	4.18	3.59	2.99	2.39	1.79
10.0	9.98	8.73	7.49	6.24	4.99	3.74

Ambient temp. [°C]

Junction to ambient thermal resistance, $R_{th\ j-a}$	< 20.0	°C/W
Junction to case thermal resistance, $R_{th\ j-c}$	< 0.30	°C/W
Case to heatsink thermal resistance, $R_{th\ c-s^2}$	< 0.10	°C/W
Maximum allowable heatsink temperature	100	°C
Maximum allowable junction temperature	125	°C

2. Thermal resistance case to heatsink valves are applicable upon application of a fine layer of silicon based thermal paste HTS02S from Electrolube between SSR and heatsink.

Heatsink Selection

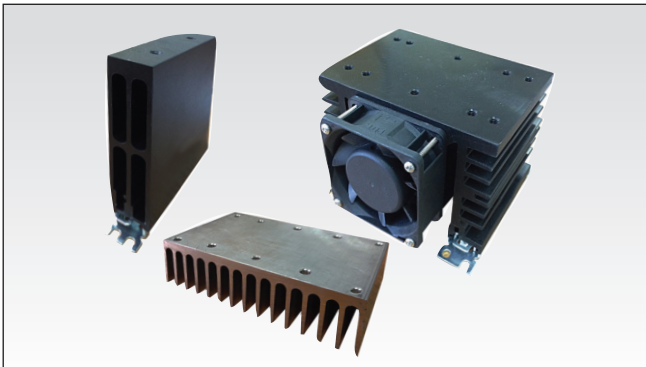

Ordering Key

RHS..

- Heatsinks and fans
- 5.40°C/W to 0.12°C/W thermal resistance
- DIN, panel or thru wall mounting
- Single or multiple SSR mounting

Heatsink Range Overview:

https://gavazziautomation.com/images/PIM/DATASHEET/ENG/SSR_Accessories.pdf

Heatsink Selector Tool:

https://gavazziautomation.com/nsc/hq/en/solid_state_relays

Short Circuit Protection

Protection Co-ordination, Type 1 vs. Type 2:

Type 1 protection implies that after a short circuit, the device under test will no longer be in a functioning state. In type 2 co-ordination the device under test will still be functional after the short circuit. In both cases, however, the short circuit has to be interrupted. The fuse between enclosure and supply shall not open. The door or cover of the enclosure shall not be blown open. There shall be no damage to conductors of terminals and the conductors shall not separate from terminals. There shall be no breakage or cracking of insulating bases to the extent that the integrity of the mounting of live parts is impaired. Discharge of parts or any risk of fire shall not occur.

The product variants listed in the table hereunder are suitable for use on a circuit capable of delivering not more than 65,000A rms Symmetrical Amperes, 600Volts maximum when protected by fuses. Tests at 65,000A were performed with Class J, fast acting: please refer to the table below for maximum allowed ampere rating of the fuse. Use fuses only.

Co-ordination type 1 (UL508)

Part No.	Prospective short circuit current [kArms]	Max. fuse size [A]	Class/ Model	Voltage [VAC]
RM1..25..	65	30	J or CC	600
RM1..50..	65	30	J	600
		20	HSJ20 (Mersen*)	600
RM1..75..	65	80	J	600
		60	HSJ60 (Mersen*)	600
RM1..100..	65	80	J	600
		60	HSJ60 (Mersen*)	600

Co-ordination type 2 (IEC/EN60947-4-3)

Part No.	Prospective short circuit current [kArms]	Max. fuse size [A]	Brand	Model	Size
RM1.xx.25.. (xx = 23, 40 or 48)	10	25	Mersen*	6.9 gRB 10-25	10.3 x 38
RM1.60.25..	10	20	Mersen*	6.9 gRB 10-20	10.3 x 38
RM1.xx.50.. (xx = 23 or 40)	10	50	Mersen*	6.9zz CP gRC 14x51/50	14 x 51
RM1.xx.50.. (xx = 48 or 60)	10	50	Mersen*	6.9zz CP gRC 22x58/50	22 x 58
RM1.xx.75.. (xx = 23, 40, 48 or 60)	10	63	Mersen*	6.9zz CP gRC 22x58/63	22 x 58
RM1.xx.100.. (xx = 23, 40, 48 or 60)	10	100	Mersen*	6.9zz CP gRC 22x58/100	22 x 58

zz = 00, without fuse trip indication

zz = 21, with fuse trip indication

* Formerly Ferraz Shawmut

Type 2 Protection with Miniature Circuit Breakers (M.C.B.s)

Solid State Relay type	ABB Model no. for Z - type M. C. B. (rated current)	ABB Model no. for B - type M. C. B. (rated current)	Wire cross sectional area [mm ²]	Minimum length of Cu wire conductor [m]	
RM1..25..	1-pole				
	S201-Z4 (4A)	S201-B2 (2A)	1.0	21.0	
	S201-Z6 UC (6A)	S201-B2 (2A)	1.0	21.0	
			1.5	31.5	
RM1..50..	1-pole				
	S201-Z10 (10A)	S201-B4 (4A)	1.0	7.6	
			1.5	11.4	
			2.5	19.0	
	S201-Z16 (16A)	S201-B6 (6A)	1.0	5.2	
			1.5	7.8	
			2.5	13.0	
			4.0	20.8	
	S201-Z20 (20A)	S201-B10 (10A)	1.5	12.6	
			2.5	21.0	
	S201-Z25 (25A)	S201-B13 (13A)	2.5	25.0	
			4.0	40.0	
	2-pole	S202-Z25 (25A)	S202-B13 (13A)	2.5	19.0
4.0				30.4	
RM1..75..	1-pole				
	S201-Z20 (20A)	S201-B10 (10A)	1.5	4.2	
			2.5	7.0	
			4.0	11.2	
	S201-Z32 (32A)	S201-B16 (16A)	2.5	13.0	
			4.0	20.8	
			6.0	31.2	
	2-pole	S202-Z20 (20A)	S202-B10 (10A)	1.5	1.8
				2.5	3.0
				4.0	4.8
	S202-Z32 (32A)	S202-B16 (16A)	2.5	5.0	
			4.0	8.0	
			6.0	12.0	
10.0			20.0		
S202-Z50 (50A)	S202-B25 (25A)	4.0	14.8		
		6.0	22.2		
		10.0	37.0		
RM1..100..	1-pole				
	S201-Z50 (50A)	S201-B25 (25A)	4.0	4.8	
			6.0	7.2	
			10.0	12.0	
			16.0	19.2	
	S201-Z63 (63A)	S201-B32 (32A)	6.0	7.2	
			10.0	12.0	
16.0			19.2		

* Between MCB and Load (including return path which goes back to the mains).

Note: A prospective current of 6kA and a 230/400V power supply system is assumed for the above suggested specifications. For cables with different cross section than those mentioned above please consult Carlo Gavazzi's Technical Support Group.



Environmental Information

The declaration in this section is prepared in compliance with People's Republic of China Electronic Industry Standard SJ/T11364-2014: Marking for the Restricted Use of Hazardous Substances in Electronic and Electrical Products.

Part Name	Toxic or Harardous Substances and Elements					
	Lead (Pb)	Mercury (Hg)	Cadmium (Cd)	Hexavalent Chromium (Cr(VI))	Polybrominated biphenyls (PBB)	Polybrominated diphenyl ethers (PBDE)
Power Unit Assembly	x	0	0	0	0	0
O: Indicates that said hazardous substance contained in homogeneous materials fot this part are below the limit requirement of GB/T 26572. X: Indicates that said hazardous substance contained in one of the homogeneous materials used for this part is above the limit requirement of GB/T 26572.						

环境特性

这份申明根据中华人民共和国电子工业标准 SJ/T11364-2014：标注在电子电气产品中限定使用的有害物质

零件名称	有毒或有害物质与元素					
	铅 (Pb)	汞 (Hg)	镉 (Cd)	六价铬 (Cr(VI))	多溴化联苯 (PBB)	多溴联苯醚 (PBDE)
功率单元	x	0	0	0	0	0
O:此零件所有材料中含有的该有害物低于GB/T 26572的限定。 X: 此零件某种材料中含有的该有害物高于GB/T 26572的限定。						



FASTON terminals



- Faston tabs
- Tab dimensions according to DIN 46342 part 1
- Pure tin-plated brass

Ordering Key

Screw mounted Faston terminals

RM1A48D25 | F 4*

RS, RM Solid State Relay

Faston terminals

Tab orientation

Input Tab width: 4.8mm

Output Tab width: 6.3mm

Faston terminals in packs of 20

RM48 | F4***

RS, RM Solid State Relay

Tab orientation

- * 0: Flat (0°)
- 4: Angled (45°)

- ** 48: 4.8mm faston for input
- 63: 6.3mm faston for output

Fork Terminals

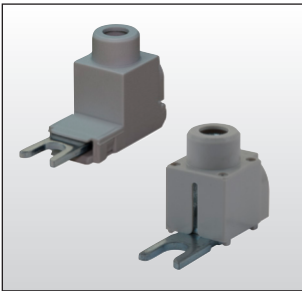

- Terminal adaptors for 35mm² cable
- Type RM635FK
- Pack size: 10 pieces

Ordering Key

RM635FK | P

RM terminal adaptor

Touch protected (optional)

Other Accessories

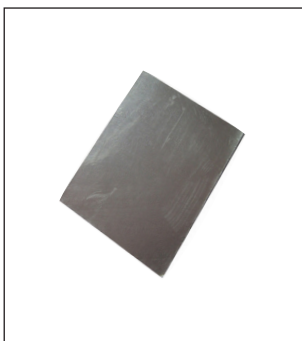

- Graphite thermal pad with adhesive on one side
- Type KK071CUT
- Dimensions: 35 x 43 x 0.25mm
- Packing quantity: 50pcs.



- Touch safety cover
- Type RMIP20
- IP20 protection degree
- Pack size: 20 pieces

All accessories can be ordered pre-assembled with Solid State Relays.
Other accessories include DIN rail adaptors, fuses, varistors and spacers.

For further information refer to Accessories datasheets at:
https://gavazziautomation.com/images/PIM/DATASHEET/ENG/SSR_Accessories.pdf

Mouser Electronics

Authorized Distributor

Click to View Pricing, Inventory, Delivery & Lifecycle Information:

Carlo Gavazzi:

[RM1A40A50](#) [RM1A40D50](#) [RM1A23D50](#) [RM1A23D75](#) [RM1A60D100](#) [RM1A60D75](#) [RM1A23A25](#) [RM1A40D100](#)
[RM1B23D100](#) [RM1B23D25](#) [RM1B48D25](#) [RM1B48D50](#) [RM1B48D75](#) [RM1A23A100](#) [RM1A60A100](#) [RM1B60D100](#)
[RM1A48D25](#) [RM1A40A75](#) [RM1A40D25](#) [RM1A48D75](#) [RM1B40D75](#) [RM1B60D75](#) [RM1A23A50](#) [RM1A23D100](#)
[RM1A40A25](#) [RM1A48A75](#) [RM1A48D50](#) [RM1A60A25](#) [RM1A60D25](#) [RM1B40D25](#) [RM1B40D50](#) [RM1A48A100](#)
[RM1A48A25](#) [RM1A48A50](#) [RM1A60A75](#) [RM1A60D50](#) [RM1B60D25](#) [RM1A23A75](#) [RM1A23D25](#) [RM1A48D100](#)
[RM1B23D75](#) [RM1B48D100](#) [RM1B40D100](#) [RM1B60D50](#) [RM1A60A50](#) [RM1B23D50](#) [RM1A40A100](#) [RM1A40D75](#)
[RM1B23A100](#) [RM1B23A25](#) [RM1B40A100](#) [RM1B40A75](#) [RM1B48A100](#) [RM1B48A25](#) [RM1B48A50](#) [RM1B48A75](#)
[RM1B60A100](#) [RM1B60A25](#) [RM1B60A50](#) [RM1B60A75](#)