

MFG. ENG.	APPROVED BY:	DATE:	QA	APPROVED BY:	DATE:
-----------	--------------	-------	----	--------------	-------

ASS'Y P/N	CONTACT QTY.	CABLE O.D. RANGE
W18282-2PG-P-311	2	0.09 - 0.14 [2.3 - 3.6]
W18282-2PG-P-315	2	0.15 - 0.17 [3.8 - 4.3]
W18282-2PG-P-318	2	0.18 - 0.20 [4.6 - 5.1]
W18282-3PG-P-311	3	0.09 - 0.14 [2.3 - 3.6]
W18282-3PG-P-315	3	0.15 - 0.17 [3.8 - 4.3]
W18282-3PG-P-318	3	0.18 - 0.20 [4.6 - 5.1]
W18282-XPG-P-3XX		

NOTES:

1. ALL PARTS ARE BULK PACKED.
2. REFER TO DRAWING HPMCSTD FOR CONTACT PATTERNS.
3. ALL DIMENSIONS ARE REFERENCE ONLY IN INCHES [mm], WITHIN ±0.015 UNLESS OTHERWISE NOTED.

OF CONTACTS

GROMMET SIZE = CABLE O.D. RANGE:

- 311 = 0.09 - 0.14 [2.3 - 3.6]
- 315 = 0.15 - 0.17 [3.8 - 4.3]
- 318 = 0.18 - 0.20 [4.6 - 5.1]

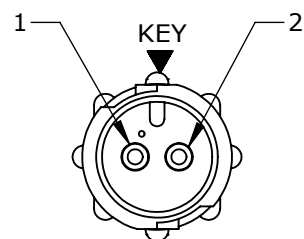

FACE VIEW
W18282-2PG-P-3XX

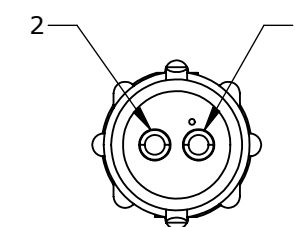
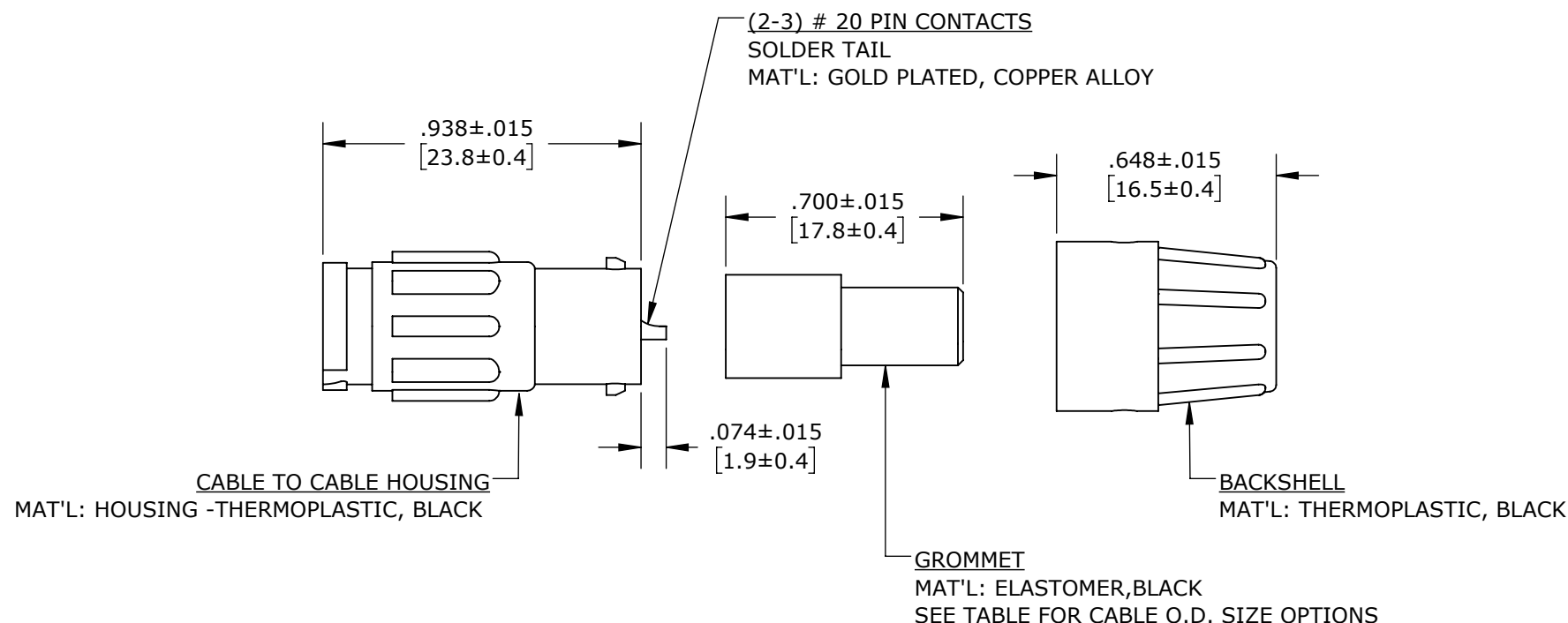

WIRING VIEW
W18282-2PG-P-3XX

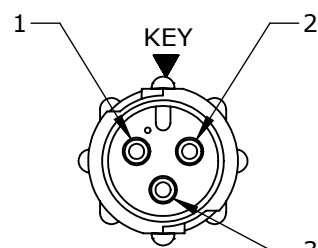

FACE VIEW
W18282-3PG-P-3XX

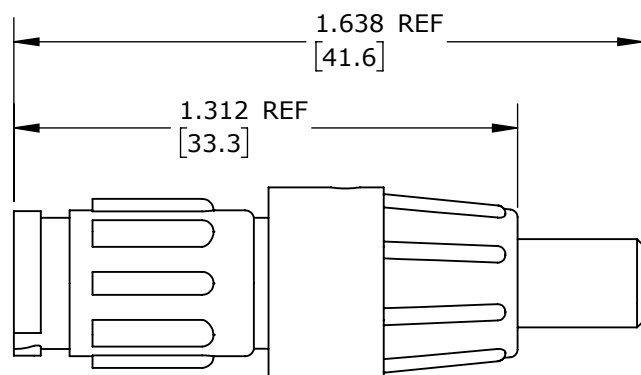

ASSEMBLED VIEW
FOR CUSTOMER REF. ONLY

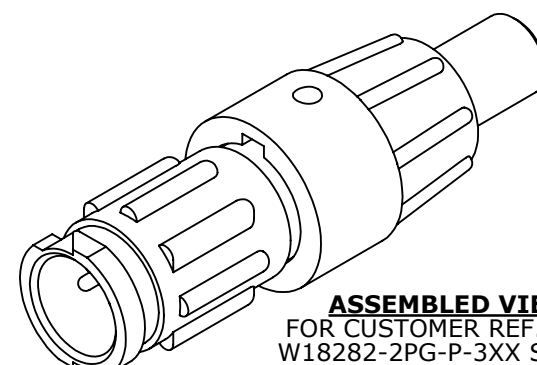

ASSEMBLED VIEW
FOR CUSTOMER REF. ONLY
W18282-2PG-P-3XX SHOWN

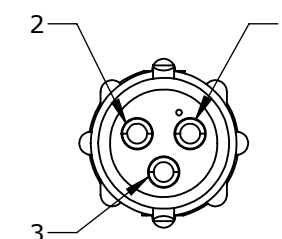

WIRING VIEW
W18282-3PG-P-3XX

CUSTOMER PRINT

PART NUMBER: W18282-XPG-P-3XX

CUSTOMER APPROVAL

THIS DOCUMENT CONTAINS CONFIDENTIAL INFORMATION PROPRIETARY TO CONXALL CORPORATION. ANY REPRODUCTION, DISCLOSURE, OR USE OF THIS DOCUMENT /INFORMATION IS EXPRESSLY PROHIBITED UNLESS AUTHORIZED IN WRITING BY CONXALL CORPORATION.

APPROVED BY: _____
DATE: _____

RoHS COMPLIANT

DIMENSIONS IS BRACKETS [] ARE METRIC

PRELIMINARY

0A	JGK	8/22/19	DRAWING CREATED FOR PDR #18004.		
REV.	INIT.	DATE	DESCRIPTION		
			ORIG. DRAWN BY: JGK	DATE: 8/22/19	<p>601 E. WILDWOOD VILLA PARK, IL 60181</p>
			CHECKED BY:		
<small>ALL INFORMATION ILLUSTRATED IS THE PROPERTY OF "CONXALL CORPORATION." UNAUTHORIZED DUPLICATION OR DISTRIBUTION OF THIS DOCUMENT IS PROHIBITED.</small>			<small>ALL UNITS ARE IN FEET, INCHES, FRACTION OF INCHES AND DECIMALS.</small>		TITLE: CABLE TO CABLE CONN. ASS'Y (2-3) #20 PIN CONTACTS, SOLDER INSTA-CLICK, MICRO-CON-X STANDARD PRODUCT CUSTOMER:
<small>UNLESS OTHERWISE SPECIFIED TOLERANCES: 3 PLACE DECIMALS ±.005 ANGLES ±1° FRACTIONS ±1/16</small>			<small>APPROVED BY:</small>	<small>SCALE: NTS</small>	
<small>UNLESS OTHERWISE SPECIFIED TOLERANCES: 3 PLACE DECIMALS ±.005 ANGLES ±1° FRACTIONS ±1/16</small>			<small>SIZE: B</small>	<small>SHEET: 1 OF 1</small>	<small>PART NUMBER: W18282-XPG-P-3XX</small>
<small>FILE: W18282-XPG-P-3XX</small>			<small>DIRECTORY: SLW</small>	<small>REV: 0A</small>	

Mouser Electronics

Authorized Distributor

Click to View Pricing, Inventory, Delivery & Lifecycle Information:

Switchcraft:

[W18282-3PG-P-315](#) [W18282-3PG-P-311](#) [W18282-2PG-P-315](#) [W18282-2PG-P-318](#) [W18282-2PG-P-311](#) [W18282-3PG-P-318](#)