

CUSTOMER PRINT

PART NUMBER: W16980-XSG-P-5XX

NOTES:

1. ALL PARTS TO BE BULK PACKED
2. CONTACTS SHIPPED UNASSEMBLED
3. ALL DIMENSIONS ARE REFERENCE EXCEPT THOSE WITH A TOLERANCE

ASS'Y P/N	FOR CABLE O.D.
W16980-XSG-P-518	.175-.185 [4.4-4.7]
W16980-XSG-P-521	.205-.215 [5.2-5.5]
W16980-XSG-P-522	.215-.225 [5.5-5.7]

ASS'Y P/N	KEY STYLE	CONTACT QTY.
W16980-5SG-P-5XX	A-KEY	5
W16980-6SG-P-5XX	B-KEY	6
W16980-7SG-P-5XX	A-KEY	7
W16980-XSG-P-5XX		

GROMMET SIZE  
NUMBER OF CONTACTS

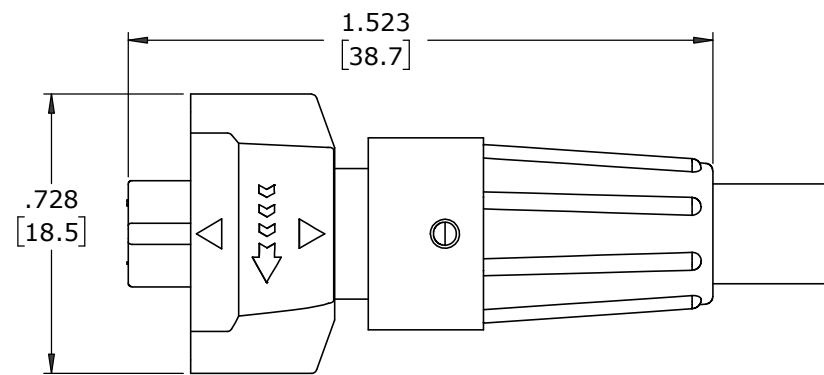

SHOWN ASSEMBLED  
FOR CUSTOMER REFERENCE ONLY

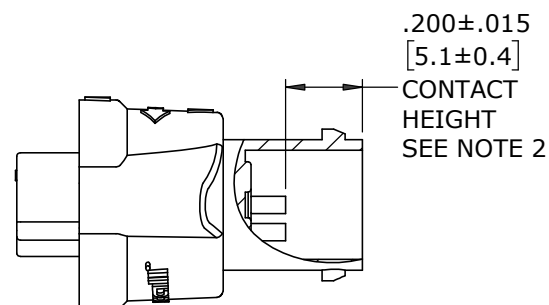

(5-7) #26 SOCKET CONTACTS, CRIMP  
MAT'L: GOLD PLATED COPPER ALLOY

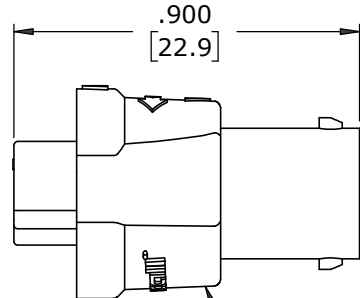

CABLE END HOUSING, FEMALE  
MAT'L: UV PBT, BLACK  
COUPLING RING  
MAT'L: UV PBT, BLACK  
O-RING  
MAT'L: SILICONE, RED  
SPRING  
MAT'L: STAINLESS STEEL

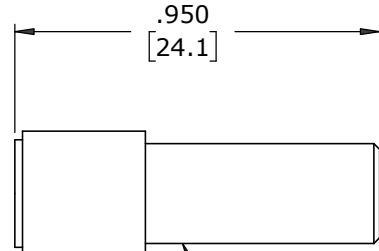

GROMMET  
MAT'L: RUBBER, BLACK

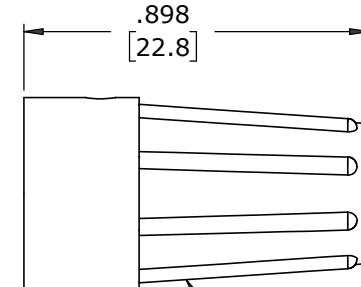

BACKSHELL  
MAT'L: UV PBT, BLACK

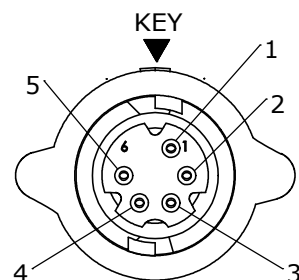

**FACE VIEW**  
W16980-5SG-P-5XX  
5 POSITION  
A-KEY

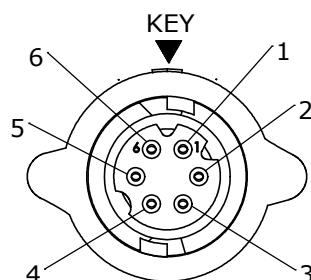

**FACE VIEW**  
W16980-6SG-P-5XX  
6 POSITION  
B-KEY

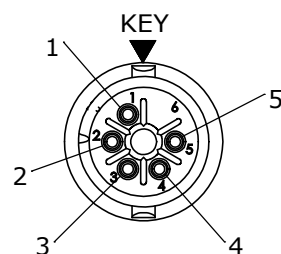

**WIRING VIEW**  
W16980-5SG-P-5XX

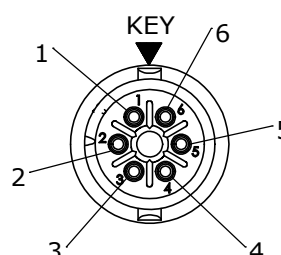

**WIRING VIEW**  
W16980-6SG-P-5XX

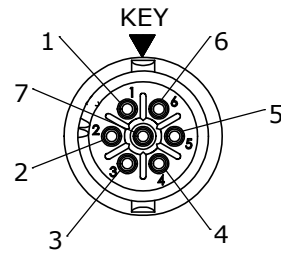

**WIRING VIEW**  
W16980-7SG-P-5XX

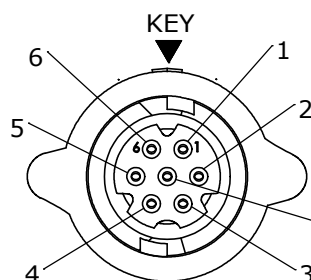

**FACE VIEW**  
W16980-7SG-P-5XX  
7 POSITION  
A-KEY

DIMENSIONS IN BRACKETS [ ] ARE METRIC

**CUSTOMER APPROVAL**

THIS DOCUMENT CONTAINS CONFIDENTIAL INFORMATION PROPRIETARY TO CONXALL CORPORATION. ANY REPRODUCTION, DISCLOSURE, OR USE OF THIS DOCUMENT /INFORMATION IS EXPRESSLY PROHIBITED UNLESS AUTHORIZED IN WRITING BY CONXALL CORPORATION.

APPROVED BY: \_\_\_\_\_  
DATE: \_\_\_\_\_

MA	08-18-20	RELEASED PER PDR 18004-4
A	JGK	2/28/20
	JGK	9/09/19
REV.	INIT.	DATE
<small>ALL INFORMATION ILLUSTRATED IS THE PROPERTY OF "CONXALL CORPORATION". UNAUTHORIZED DUPLICATION OR DISTRIBUTION OF THIS DOCUMENT IS PROHIBITED.</small>		<small>ORIG. DRAWN BY: JGK</small> <small>DATE: 9/09/19</small>
<small>ALL UNITS ARE IN FEET, INCHES, FRACTION OF INCHES AND DECIMALS.</small>		<p>601 E. WILDWOOD VILLA PARK, IL 60181</p>
<small>UNLESS OTHERWISE SPECIFIED TOLERANCES: 3 PLACE DECIMALS ±.005 ANGLES ±1° FRACTIONS ±1/16</small>		
APPROVED BY:	SCALE	SIZE
	NTS	B
	FILE:	SHEET
	W16980-XSG-P-5XX	1 OF 1
	DIRECTORY:	PART NUMBER:
	SLW	W16980-XSG-P-5XX
		REV
		A

**RoHS COMPLIANT**

# Mouser Electronics

Authorized Distributor

Click to View Pricing, Inventory, Delivery & Lifecycle Information:

## Switchcraft:

[W16980-5SG-P-522](#) [W16980-6SG-P-518](#) [W16980-5SG-P-518](#) [W16980-6SG-P-521](#) [W16980-7SG-P-522](#) [W16980-6SG-P-522](#) [W16980-7SG-P-521](#)