

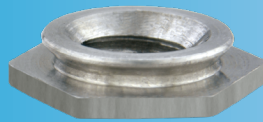

PEM® self-clinching flush nuts are flush with both sides of the sheet.



FTM

**PEMSERT®
SELF-CLINCHING
FASTENERS**

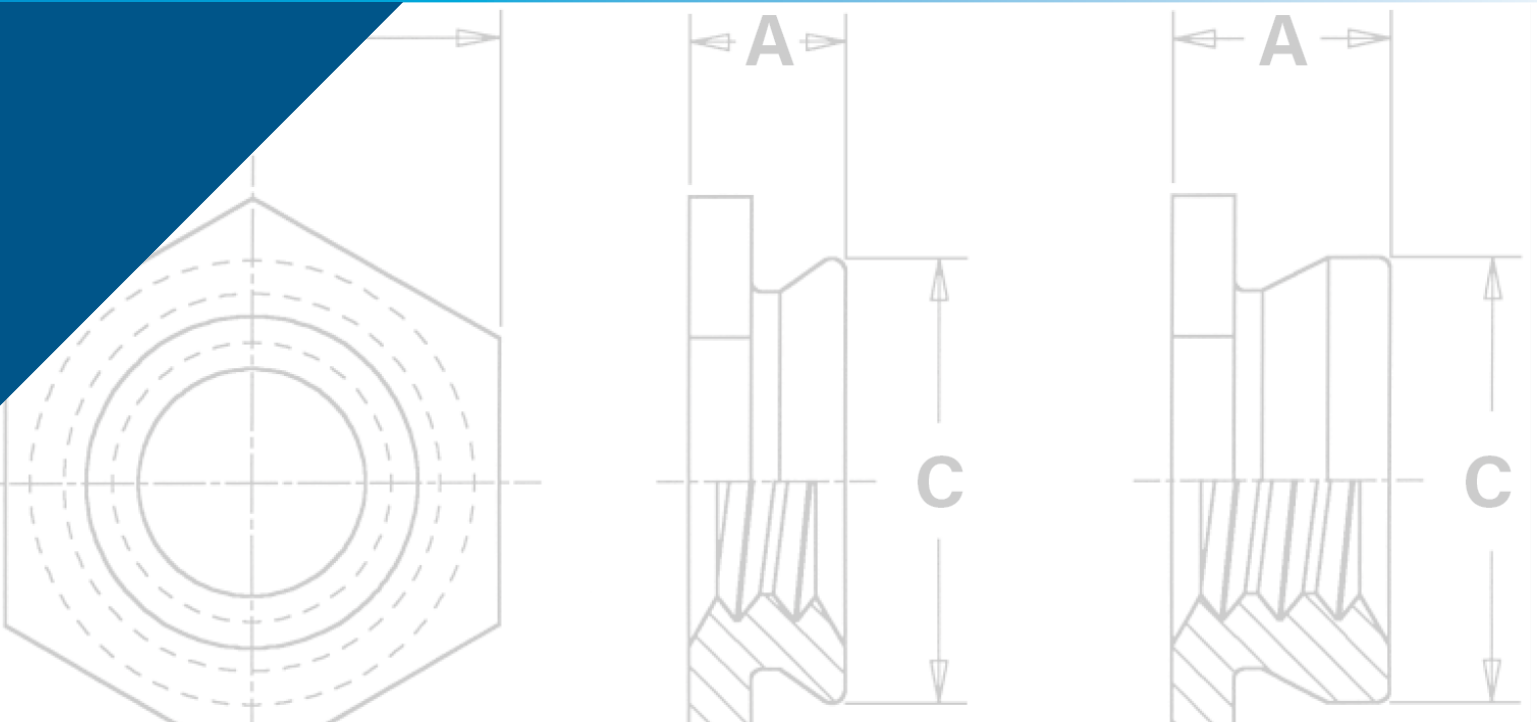

PEMSERT® self-clinching flush nuts are designed to be installed into sheets as thin as .060"/1.5 mm.

F™ and F4™ fasteners are ideal for applications where a thin sheet requires threads stronger than a tapped hole but still must remain flat, with no protrusions on either surface, enhancing the functional and cosmetic qualities of the entire assembly.

PEMSERT® flush nuts are installed easily by squeezing them into a round hole in metal sheets. They can be installed before bending and forming to provide threads in places which would be inaccessible for installation after chassis are formed. The hexagonal head along with the proven PEM® self-clinching design ensures high axial and torsional strength.

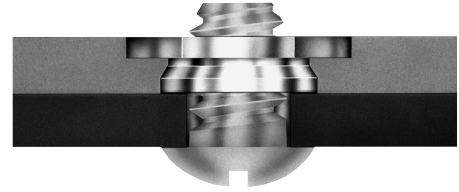

F4™ flush nuts are specifically designed to be installed into stainless steel sheets.

PEMSERT® F™ fasteners can be ordered to conform to US NASM45938/4 specifications.*

**To meet national aerospace standards and to obtain testing documentation, product must be ordered to NASM45938/4 specifications. Consult our Marketing department for a complete Military Specification and National Aerospace Standards Reference Guide (Bulletin NASM) or check our web site.*



Fastener drawings
and models are
available at
www.pemnet.com

PEMSERT® SELF-CLINCHING FLUSH FASTENERS

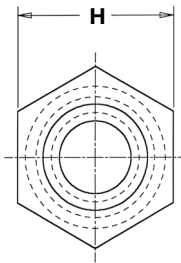

Profile for
-1 shank code.

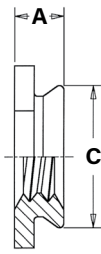

Profile for -2, -3, -4,
& -5 shank codes.

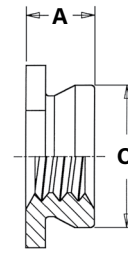

Clinching profile may vary.

PART NUMBER DESIGNATION

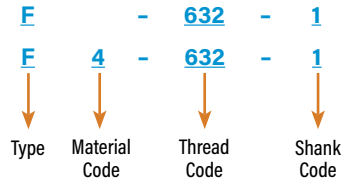

All dimensions are in inches.

UNIFIED	Thread Size	Type		Thread Code	Shank Code	A (Shank) Max.	Sheet Thickness	Hole Size In Sheet +.003 -.000	C Max.	H Nom.	Min. Dist. Hole \varnothing To Edge
		Fastener Material									
		Stainless Steel	Hardened Stainless Steel								
.086-56 (#2-56)	F	F4	256	1	.060	.060 - .091	.172	.171	.188	.23	
				2	.090	.091 Min.					
.112-40 (#4-40)	F	F4	440	1	.060	.060 - .091	.172	.171	.188	.23	
				2	.090	.091 Min.					
.138-32 (#6-32)	F	F4	632	1	.060	.060 - .091	.213	.212	.250	.27	
				2	.090	.091 Min.					
.164-32 (#8-32)	F	F4	832	1	.060	.060 - .091	.290	.289	.312	.28	
				2	.090	.091 Min.					
.190-32 (#10-32)	F	F4	032	1	.060	.060 - .091	.312	.311	.343	.31	
				2	.090	.091 Min.					
.250-20 (1/4-20)	F	F4	0420	3	.120	.125 - .156	.344	.343	.375	.34	
				4	.151	.156 - .187					
				5	.182	.187 Min.					

All dimensions are in millimeters.

METRIC	Thread Size	Type		Thread Code	Shank Code	A (Shank) Max.	Sheet Thickness	Hole Size In Sheet +0.08	C Max.	H Nom.	Min. Dist. Hole \varnothing To Edge
		Fastener Material									
		300 Series Stainless Steel	Hardened Stainless Steel								
M2 x 0.4	F	F4	M2	1	1.53	1.53 - 2.32	4.37	4.35	4.8	6	
				2	2.3	2.32 Min.					
M2.5 x 0.45	F	F4	M2.5	1	1.53	1.53 - 2.32	4.37	4.35	4.8	6	
				2	2.3	2.32 Min.					
M3 x 0.5	F	F4	M3	1	1.53	1.53 - 2.32	4.37	4.35	4.8	6	
				2	2.3	2.32 Min.					
M4 x 0.7	F	F4	M4	1	1.53	1.53 - 2.32	7.37	7.35	7.9	7.2	
				2	2.3	2.32 Min.					
M5 x 0.8	F	F4	M5	1	1.53	1.53 - 2.32	7.92	7.9	8.7	8	
				2	2.3	2.32 Min.					
M6 x 1	F	F4	M6	3	3.05	3.18 - 3.96	8.74	8.72	9.5	8.8	
				4	3.84	3.96 - 4.75					
				5	4.63	4.75 Min.					



MATERIAL AND FINISH SPECIFICATIONS

Type	Threads	Fastener Materials		Standard Finish	For Use in Sheet Hardness: (1)	
	Internal, ASME B1.1, 2B / ASME B1.13M, 6H	300 Series Stainless Steel	Hardened 400 Series Stainless Steel	Passivated and/or Tested Per ASTM A380	HRB 88 / HB 183 or less	HRB 70 / HB 125 or less
F	▪	▪		▪		▪
F4	▪		▪	▪	▪	
Part Number Code For Finishes				None		

(1) HRB - Hardness Rockwell "B" Scale. HB - Hardness Brinell.

A NOTE ABOUT HARDENED 400 SERIES STAINLESS STEEL

In order for self-clinching fasteners to work properly, the fastener must be harder than the sheet into which it is being installed. In the case of stainless steel panels, fasteners made from 300 Series Stainless Steel do not meet this hardness criteria. It is for this reason that 400 series F4™ fasteners are offered. However, while these 400 Series fasteners install and perform well in 300 Series stainless sheets they should not be used if the end product:

- Will be exposed to any appreciable corrosive environment.
- Requires non-magnetic fasteners.
- Will be exposed to any temperatures above 300° F (149° C)

If any of these are issues, please contact techsupport@pemnet.com for other options.

PEMSERT® SELF-CLINCHING FLUSH FASTENERS

INSTALLATION

1. Prepare properly sized round mounting hole in sheet. Do not perform any secondary operations such as deburring.
2. Place fastener onto the anvil and place the mounting hole (preferably the punch side) over the shank of the fastener.
3. With installation punch and anvil surfaces parallel, apply sufficient squeezing force only to embed hexagonal head flush in sheet. The metal displaced by the head flows evenly and smoothly around the back-tapered shank of the fastener, securely locking it into place with high pullout resistance while at the same time, the embedded hexagonal head provides high torque resistance.

Installation Tooling - F and F4 Nuts

Thread Code	HAEGER® Part Number		PEMSERTER® Part Number		Anvil Dimensions			
	Anvil	Punch	Anvil	Punch	A		P	
					+ .002" - .000"	+ 0.05mm	± .005"	± 0.13mm
256/M2/M2.5	H-108-0018L	H-108-0018L	8006193	975200048	.060"	1.52mm	.050"	1.27mm
440/M3	H-108-0018L	H-108-0018L	975200040	975200048	.077"	1.96mm	.050"	1.27mm
632	H-108-0018L	H-108-0018L	975200041	975200048	.092"	2.34mm	.050"	1.27mm
832/M4	H-108-0018L	H-108-0018L	975200042	975200048	.124"	3.15mm	.050"	1.27mm
032/M5	H-108-0018L	H-108-0018L	975200043	975200048	.139"	3.53mm	.050"	1.27mm
0420/M6	H-108-0018L	H-108-0018L	975200044	975200048	.186"	4.72mm	.100"	2.54mm

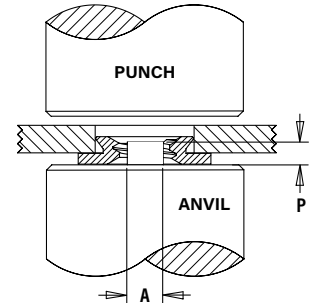

Installation Notes

- For best results we recommend using a HAEGER® or PEMSERTER® machine for installation of PEM® self-clinching fasteners. See our [website](#) for more information.
- Visit the [Animation Library](#) on our website to view the installation process.

For Additional HAEGER® and PEMSERTER® Tooling Information / Part Numbers



HAEGER® MANUAL TOOLING CATALOG

HAEGER® AUTO TOOLING CATALOG

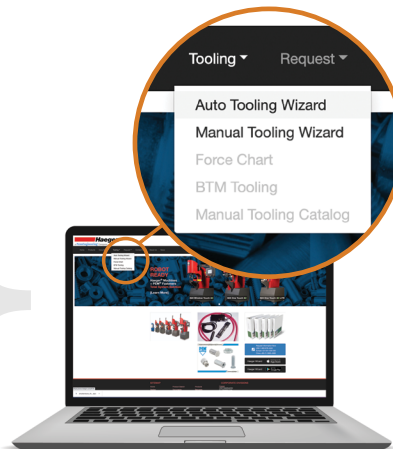

Go to haeger.com to access the Auto and Manual Tooling Wizards

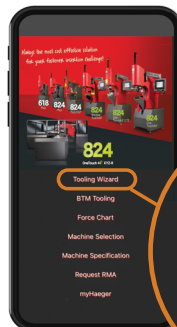

Or download the HAEGER WIZZARD Phone App

OneTouch 4e XYZ-R

Tooling Wizard

BTM Tooling



PEMSERTER® MANUAL TOOLING CATALOG

PEMSERTER® AUTO TOOLING CATALOG



PEMSERT® SELF-CLINCHING FLUSH FASTENERS

PERFORMANCE DATA⁽¹⁾

F™ NUTS

UNIFIED	Thread Code	Shank Code	Axial Tensile Strength (lbs.) (2)	Rec. Tightening Torque (3) (in. lbs.)	Test Sheet Material			
					5052-H34 Aluminum		Cold-rolled Steel	
					Installation (lbs.)	Pushout (lbs.)	Installation (lbs.)	Pushout (lbs.)
256	1	2	130	1.50	2000	150	3000	200
		2						
440	1	2	165	2.50	2000	150	3000	200
		2						
632	1	2	190	3.50	2000	200	3600	200
		2						
832	1	2	230	5.25	2000	240	4000	240
		2						
032	1	2	280	7.50	2500	240	5000	240
		2						
0420	3	4	1035	36	3500	640	6000	840
		4						
		5						
		5						

METRIC	Thread Code	Shank Code	Axial Tensile Strength (kN) (2)	Rec. Tightening Torque (3) (N-m)	Test Sheet Material			
					5052-H34 Aluminum		Cold-rolled Steel	
					Installation (kN)	Pushout (N)	Installation (kN)	Pushout (N)
M2	1	2	0.57	0.16	8.9	665	13.3	890
		2						
M2.5	1	2	0.68	0.23	8.9	665	13.3	890
		2						
M3	1	2	0.85	0.36	8.9	665	13.3	890
		2						
M4	1	2	1	0.58	8.9	1068	17.8	1068
		2						
M5	1	2	1.3	0.88	11.1	1068	22.2	1068
		2						
M6	3	4	4.5	3.7	15.6	2847	26.7	3736
		4						
		5						
		5						

F4™ NUTS

UNIFIED	Thread Code	Shank Code	Axial Tensile Strength (lbs.) (2)	Rec. Tightening Torque (3) (in. lbs.)	Test Sheet Material	
					300 Series Stainless Steel	
					Installation (lbs.)	Pushout (lbs.)
256	1	2	130	1.50	7200	270
		2				
440	1	2	165	2.50	7200	270
		2				
632	1	2	190	3.50	7200	290
		2				
832	1	2	230	5.25	9000	450
		2				
032	1	2	280	7.50	9000	450
		2				
0420	3	4	1035	36	14000	1000
		4				
		5				
		5				

METRIC	Thread Code	Shank Code	Axial Tensile Strength (kN) (2)	Rec. Tightening Torque (3) (N-m)	Test Sheet Material	
					300 Series Stainless Steel	
					Installation (kN)	Pushout (N)
M2	1	2	0.57	0.16	32	1200
		2				
M2.5	1	2	0.68	0.23	32	1200
		2				
M3	1	2	0.85	0.36	32	1200
		2				
M4	1	2	1	0.58	40	2000
		2				
M5	1	2	1.3	0.88	40	2000
		2				
M6	3	4	4.5	3.7	65	4500
		4				
		5				
		5				

(1) Published installation forces are for general reference. Actual set-up and confirmation of complete installation should be made by observing proper seating of fastener as described in the installation steps. Other performance values reported are averages when all proper installation parameters and procedures are followed. Variations in mounting hole size, sheet material, and installation procedure may affect performance. Performance testing this product in your application is recommended. We will be happy to provide technical assistance and/or samples for this purpose.

(2) Failure occurs in screw stripping using a 60 ksi screw and the shortest shank length fastener.

(3) Torque values shown will produce a preload of 70% of axial tensile strength with nut factor "k" equal to .2. Threads may strip or head of the F nut may bend and/or fail if screw is over-torqued beyond these values or if actual k value is less than .2.

All PEM® products meet our stringent quality standards. If you require additional industry or other specific [quality certifications](#), special procedures and/or part numbers are required. Please contact your local sales office or representative for further information.

Regulatory [compliance information](#) is available in Technical Support section of our website. Specifications subject to change without notice. See our website for the most current version of this bulletin.

PennEngineering®



North America: Danboro, Pennsylvania USA • E-mail: info@pemnet.com • Tel: +1-215-766-8853 • 800-237-4736 (USA)

Europe: Galway, Ireland • E-mail: europe@pemnet.com • Tel: +353-91-751714

Asia/Pacific: Singapore • E-mail: singapore@pemnet.com • Tel: +65-6-745-0660

Shanghai, China • E-mail: china@pemnet.com • Tel: +86-21-5868-3688

Visit our PEMNET™ Resource Center at www.pemnet.com • Technical support e-mail: techsupport@pemnet.com

Mouser Electronics

Authorized Distributor

Click to View Pricing, Inventory, Delivery & Lifecycle Information:

PEM:

[F-032-1](#) [F-032-2](#) [F-0420-3](#) [F-0420-5](#) [F-256-1](#) [F-256-2](#) [F-M4-2](#) [F-M5-1](#) [F-M5-2](#) [F-M6-3](#) [F-M6-4](#) [FE-M4-MD](#) [FE-M5-MD](#) [F-M2.5-1](#) [F-M3-1](#) [F-M3-2](#) [F-M4-1](#) [F-632-1](#) [F-632-2](#) [F-832-1](#) [F-832-2](#) [FE-0420-MD](#) [FE-M3-MD](#) [F4-M4-1](#) [F4-M4-2](#) [F4-M5-1](#) [F4-M5-2](#) [F4-M6-3](#) [F4-M6-4](#) [F4-832-1](#) [F4-832-2](#) [F4-M2.5-1](#) [F4-M2.5-2](#) [F4-M3-1](#) [F4-M3-2](#) [F-440-1](#) [F-440-2](#) [F4-440-1](#) [F4-440-2](#) [F4-632-1](#) [F4-632-2](#) [F4-032-1](#) [F4-032-2](#) [F4-0420-3](#) [F4-0420-5](#) [F4-256-1](#) [F4-256-2](#) [F-0420-4](#) [F10-632-1ZI](#) [F10-832-1ZI](#) [F10-M5-1ZI](#) [F-M2.5-2](#) [F-M2-1](#) [F-M6-5](#) [F10-032-1ZI](#) [F10-440-1ZI](#) [F10-M3-1ZI](#) [F10-M4-1ZI](#) [F4-0420-4](#) [F4-M2-1](#) [F4-M2-2](#) [F4-M6-5](#)