

P6SMB Series

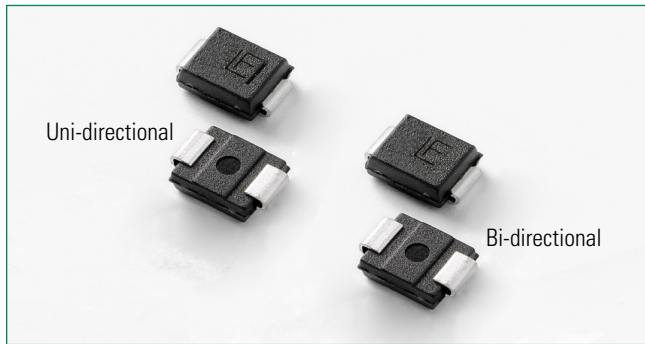

Agency Approvals

Agency	Agency File Number
	E230531

Maximum Ratings and Thermal Characteristics
(T_A = 25°C unless otherwise noted)

Parameter	Symbol	Value	Unit
Peak Pulse Power Dissipation ^(Fig.2) by 10/1000us Test Waveform ^(Fig.4) (Note 1),(Note 2)-Single Die Parts	P _{PPM}	600	W
Peak Pulse Power Dissipation ^(Fig.2) by 10/1000us Test Waveform ^(Fig.4) (Note 1, Note 2)-Stacked Die Parts (Note 5)	P _{PPM}	800	W
Power Dissipation on Infinite Heat Sink at T _L =50°C	P _D	5.0	W
Peak Forward Surge Current, 8.3ms Single Half Sine Wave (Note 3)	I _{FSM}	100	A
Maximum Instantaneous Forward Voltage at 50A for Unidirectional Only (Note 4)	V _F	3.5/5.0	V
Operating Temperature Range	T _J	-65 to 150	°C
Storage Temperature Range	T _{STG}	-65 to 175	°C
Typical Thermal Resistance Junction to Lead	R _{θJL}	20	°C/W
Typical Thermal Resistance Junction to Ambient	R _{θJA}	100	°C/W

- Notes:**
1. Non-repetitive current pulse, per Fig. 4 and derated above T_J (initial) = 25°C per Fig. 3.
 2. Mounted on copper pad area of 0.2x0.2" (5.0 x 5.0mm) to each terminal.
 3. Measured on 8.3ms single half sine wave or equivalent square wave for unidirectional device only, duty cycle=4 per minute maximum.
 4. V_F < 3.5V for single die parts and V_F < 5.0V for stacked-die parts.
 5. For stacked die component details, please refer to part numbers labeled by * in Electrical Characteristics.

Functional Diagram

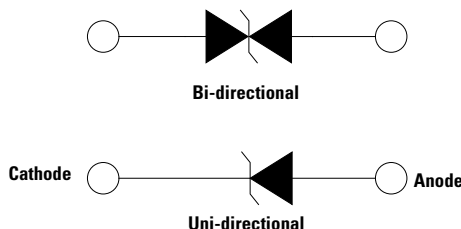

Description

The P6SMB series is designed specifically to protect sensitive electronic equipment from voltage transients induced by lightning and other transient voltage events.

Features

- 600W peak pulse power capability at 10/1000µs waveform, repetition rate (duty cycles):0.01 %
- Excellent clamping capability
- Low incremental surge resistance
- Typical I_R less than 1µA when V_{BR} min > 12V
- Optimized surface mount footprint for minimal PCB space impact
- Low profile package
- Typical failure mode due to exceeding maximum ratings is a short circuit condition
- Whisker test conducted based on Table 4a and 4c of JEDEC JESD201A
- IEC 61000-4-2 ESD 30kV(Air), 30kV (Contact)
- EFT protection of data lines in accordance with IEC 61000-4-4
- Built-in strain relief
- Fast response time: typically less than 1.0ps from 0V to V_{BR} min
- High temperature to reflow soldering guaranteed: 260°C/30sec
- V_{BR} @ T_J = V_{BR} @ 25°C x (1 + α T x (T_J - 25)) (α T: Temperature Coefficient, typical value is 0.1%)
- UL Recognized compound meeting flammability classification V-0
- Meet MSL level1, per J-STD-020, LF maximum peak of 260°C
- Matte tin lead-free plated
- Halogen free and RoHS compliant
- Pb-free E3 means 2ND level interconnect is Pb-free and the terminal finish material is tin(Sn) (IPC/ JEDEC J-STD-609A.01)
- UL Recognized to ANSI/UL 497B: Protectors for Data Communications and Fire-Alarm Circuits.

Applications

TVS devices are ideal for the protection of I/O Interfaces, V_{CC} bus and other vulnerable circuits used in Telecom, Computer, Industrial and Consumer electronic applications.

Additional Information



Datasheet



Resources



Samples

Electrical Characteristics (T_A=25°C unless otherwise noted)

Part Number (Uni)	Part Number (Bi)	Marking		Reverse Stand off Voltage V _R (Volts)	Breakdown Voltage V _{BR} (Volts) @ I _T		Test Current I _T (mA)	Maximum Clamping Voltage V _C @ I _{pp} (V)	Maximum Peak Pulse Current I _{pp} (A)	Maximum Reverse Leakage I _R @ V _R (µA)	Maximum Temperature coefficient of V _{BR} (%/°C)	Agency Approval 
		UNI	BI		MIN	MAX						
P6SMB6.8A	P6SMB6.8CA	6V8A	6V8C	5.80	6.45	7.14	10	10.5	58.1	1000	0.041	X
P6SMB7.5A	P6SMB7.5CA	7V5A	7V5C	6.40	7.13	7.88	10	11.3	54.0	500	0.054	X
P6SMB8.2A	P6SMB8.2CA	8V2A	8V2C	7.02	7.79	8.61	10	12.1	50.4	200	0.058	X
P6SMB9.1A	P6SMB9.1CA	9V1A	9V1C	7.78	8.65	9.55	1	13.4	45.5	50	0.063	X
P6SMB10A	P6SMB10CA	10A	10C	8.55	9.50	10.50	1	14.5	42.1	10	0.066	X
P6SMB11A	P6SMB11CA	11A	11C	9.40	10.50	11.60	1	15.6	39.1	5	0.069	X
P6SMB12A	P6SMB12CA	12A	12C	10.20	11.40	12.60	1	16.7	36.5	5	0.071	X
P6SMB13A	P6SMB13CA	13A	13C	11.10	12.40	13.70	1	18.2	33.5	1	0.074	X
P6SMB15A	P6SMB15CA	15A	15C	12.80	14.30	15.80	1	21.2	28.8	1	0.076	X
P6SMB16A	P6SMB16CA	16A	16C	13.60	15.20	16.80	1	22.5	27.1	1	0.080	X
P6SMB18A	P6SMB18CA	18A	18C	15.30	17.10	18.90	1	25.5	24.2	1	0.083	X
P6SMB20A	P6SMB20CA	20A	20C	17.10	19.00	21.00	1	27.7	22.0	1	0.085	X
P6SMB22A	P6SMB22CA	22A	22C	18.80	20.90	23.10	1	30.6	19.9	1	0.088	X
P6SMB24A	P6SMB24CA	24A	24C	20.50	22.80	25.20	1	33.2	18.4	1	0.091	X
P6SMB27A	P6SMB27CA	27A	27C	23.10	25.70	28.40	1	37.5	16.3	1	0.092	X
P6SMB30A	P6SMB30CA	30A	30C	25.60	28.50	31.50	1	41.4	14.7	1	0.093	X
P6SMB33A	P6SMB33CA	33A	33C	28.20	31.40	34.70	1	45.7	13.3	1	0.094	X
P6SMB36A	P6SMB36CA	36A	36C	30.80	34.20	37.80	1	49.9	12.2	1	0.096	X
P6SMB39A	P6SMB39CA	39A	39C	33.30	37.10	41.00	1	53.9	11.3	1	0.097	X
P6SMB43A	P6SMB43CA	43A	43C	36.80	40.90	45.20	1	59.3	10.3	1	0.098	X
P6SMB47A	P6SMB47CA	47A	47C	40.20	44.70	49.40	1	64.8	9.4	1	0.099	X
P6SMB51A	P6SMB51CA	51A	51C	43.60	48.50	53.60	1	70.1	8.7	1	0.100	X
P6SMB56A	P6SMB56CA	56A	56C	47.80	53.20	58.80	1	77.0	7.9	1	0.101	X
P6SMB58A	P6SMB58CA	58A	58C	52.78	55.10	60.90	1	79.8	7.7	1	0.101	-
P6SMB62A	P6SMB62CA	62A	62C	53.00	58.90	65.10	1	85.0	7.2	1	0.102	X
P6SMB68A	P6SMB68CA	68A	68C	58.10	64.60	71.40	1	92.0	6.6	1	0.103	X
P6SMB75A	P6SMB75CA	75A	75C	64.10	71.30	78.80	1	103.0	5.9	1	0.104	X
P6SMB82A	P6SMB82CA	82A	82C	70.10	77.90	86.10	1	113.0	5.4	1	0.105	X
P6SMB91A	P6SMB91CA	91A	91C	77.80	86.50	95.50	1	125.0	4.9	1	0.106	X
P6SMB100A	P6SMB100CA	100A	100C	85.50	95.00	105.00	1	137.0	4.5	1	0.106	X
P6SMB110A	P6SMB110CA	110A	110C	94.00	105.00	116.00	1	152.0	4.0	1	0.107	X
P6SMB120A	P6SMB120CA	120A	120C	102.00	114.00	126.00	1	165.0	3.7	1	0.107	X
P6SMB130A	P6SMB130CA	130A	130C	111.00	124.00	137.00	1	179.0	3.4	1	0.107	X
P6SMB150A	P6SMB150CA	150A	150C	128.00	143.00	158.00	1	207.0	2.9	1	0.108	X
P6SMB160A	P6SMB160CA	160A	160C	136.00	152.00	168.00	1	219.0	2.8	1	0.108	X
P6SMB170A	P6SMB170CA	170A	170C	145.00	162.00	179.00	1	234.0	2.6	1	0.108	X
P6SMB180A	P6SMB180CA	180A	180C	154.00	171.00	189.00	1	246.0	2.5	1	0.108	X
P6SMB200A	P6SMB200CA	200A	200C	171.00	190.00	210.00	1	274.0	2.2	1	0.108	X
P6SMB220A	P6SMB220CA	220A	220C	185.00	209.00	231.00	1	328.0	1.9	1	0.110	X
P6SMB250A	P6SMB250CA	250A	250C	214.00	237.00	263.00	1	344.0	1.8	1	0.110	X
P6SMB300A	P6SMB300CA	300A	300C	256.00	285.00	315.00	1	414.0	1.5	1	0.110	X
P6SMB350A*	P6SMB350CA*	350A	350C	300.00	332.00	368.00	1	482.0	1.7	1	0.112	X
P6SMB400A*	P6SMB400CA*	400A	400C	342.00	380.00	420.00	1	548.0	1.5	1	0.112	X
P6SMB440A*	P6SMB440CA*	440A	440C	376.00	418.00	462.00	1	602.0	1.4	1	0.112	X
P6SMB480A*	P6SMB480CA*	480A	480C	408.00	456.00	504.00	1	658.0	1.3	1	0.112	X
P6SMB510A*	P6SMB510CA*	510A	510C	434.00	485.00	535.00	1	698.0	1.2	1	0.112	X
P6SMB530A*	P6SMB530CA*	530A	530C	451.00	503.50	556.50	1	725.0	1.2	1	0.112	X
P6SMB540A*	P6SMB540CA*	540A	540C	460.00	513.00	567.00	1	740.0	1.1	1	0.112	X
P6SMB550A*	P6SMB550CA*	550A	550C	468.00	522.50	577.50	1	760.0	1.1	1	0.112	X
P6SMB600A*	P6SMB600CA*	600A	600C	512.00	570.00	630.00	1	828.0	1.0	1	0.112	-

For bidirectional type having V_R of 10 volts and less, the I_R limit is double.
 For stack-die parts, use * to label the part number.

I-V Curve Characteristics

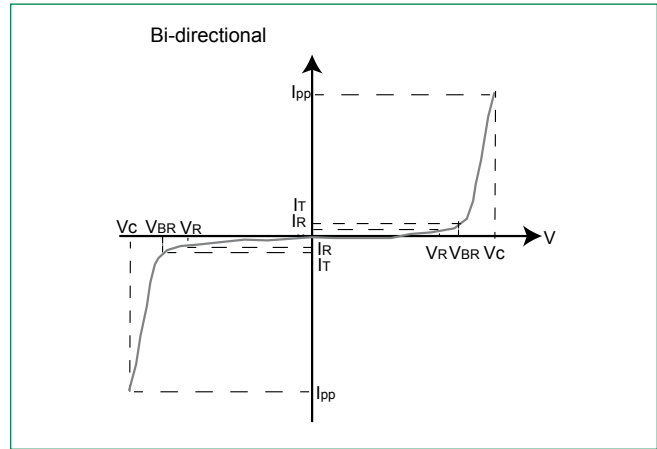
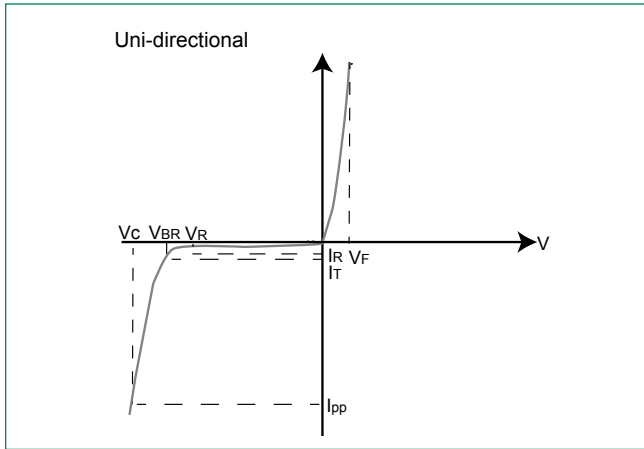

- P_{PPM} Peak Pulse Power Dissipation** – Max power dissipation ($V_C * I_{pp}$)
- V_R Stand-off Voltage** – Maximum voltage that can be applied to the TVS without operation
- V_{BR} Breakdown Voltage** – Maximum voltage that flows through the TVS at a specified test current (I_T)
- V_C Clamping Voltage** – Peak voltage measured across the TVS at a specified I_{ppm} (peak impulse current)
- I_R Reverse Leakage Current** – Current measured at V_R
- V_F Forward Voltage Drop for Uni-directional**

Ratings and Characteristic Curves ($T_A=25^\circ\text{C}$ unless otherwise noted)

Figure 1 - TVS Transients Clamping Waveform

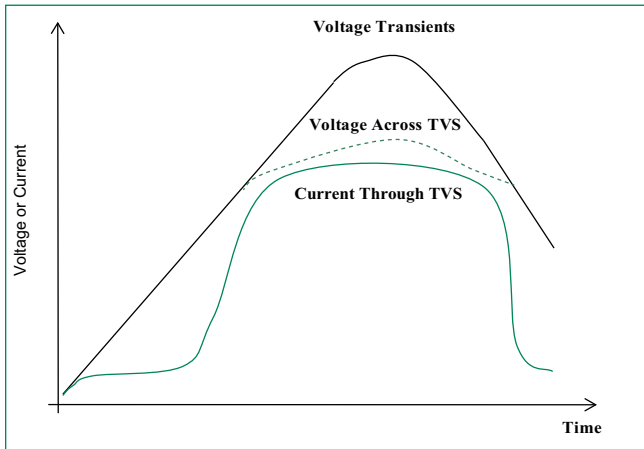
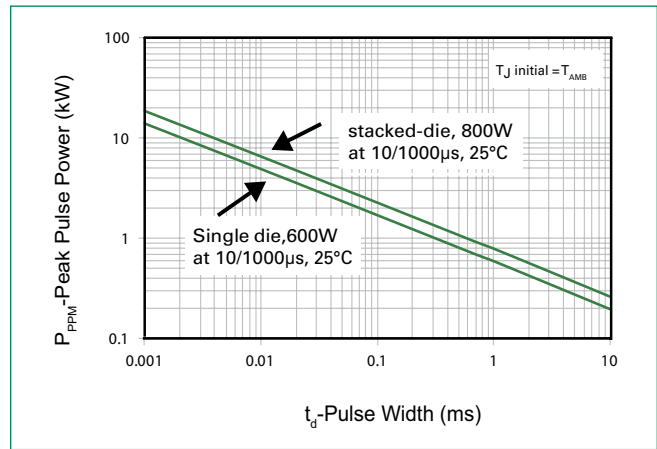

Figure 2 - Peak Pulse Power Rating



Ratings and Characteristic Curves ($T_A=25^{\circ}\text{C}$ unless otherwise noted) (Continued)

Figure 3 - Peak Pulse Power Derating Curve

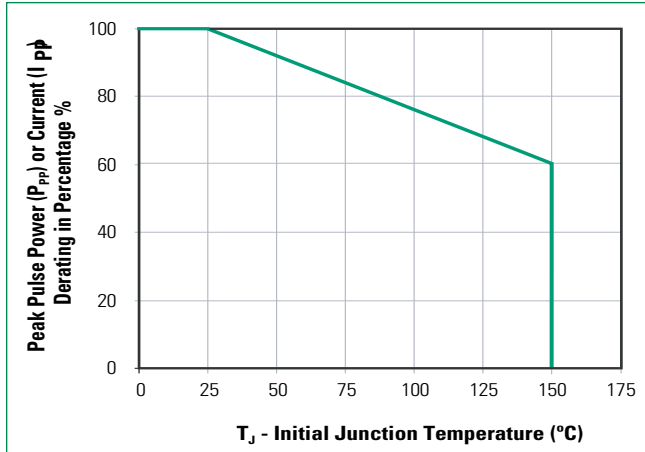

Figure 4 - Pulse Waveform

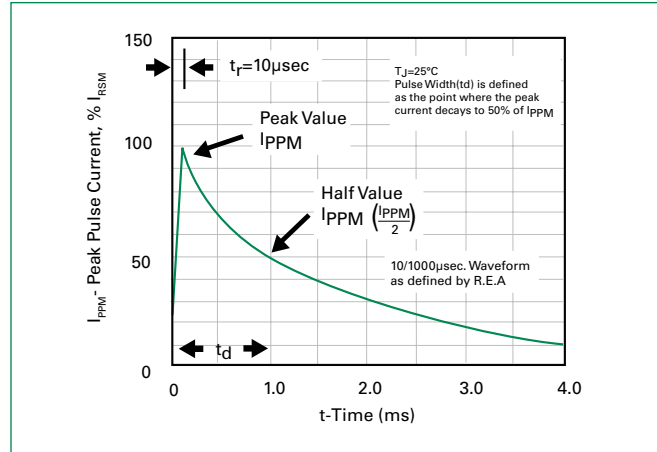

Figure 5 - Typical Junction Capacitance

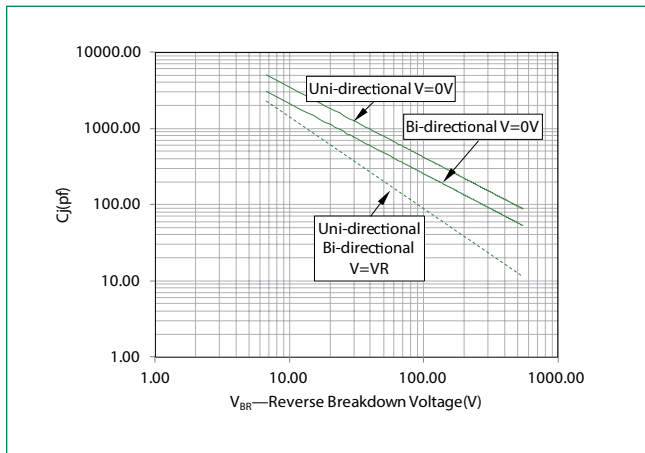

Figure 6 - Typical Transient Thermal Impedance

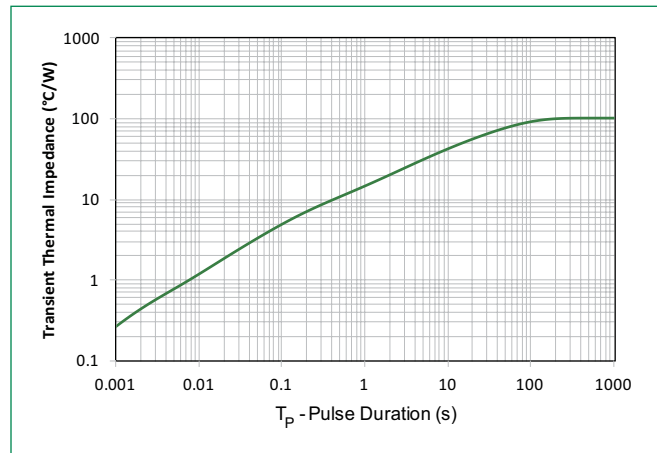

Figure 7 - Maximum Non-Repetitive Peak Forward Surge Current Uni-Directional Only

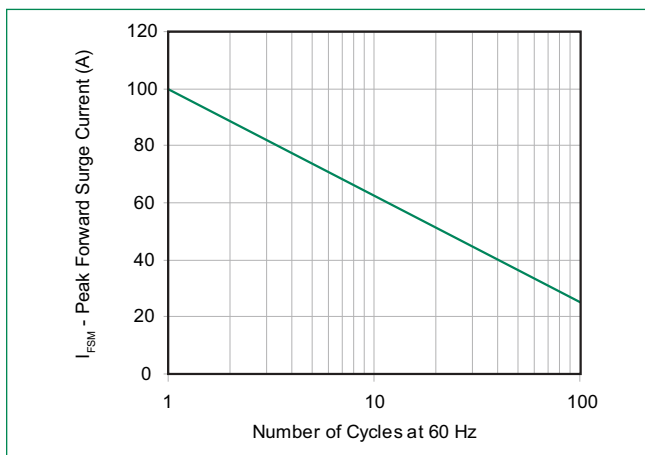
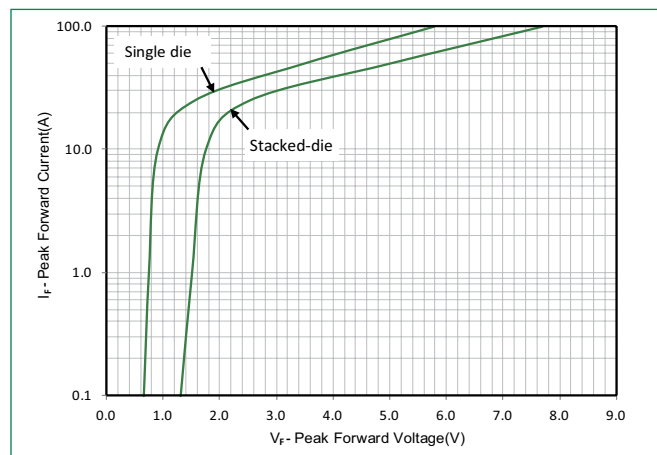
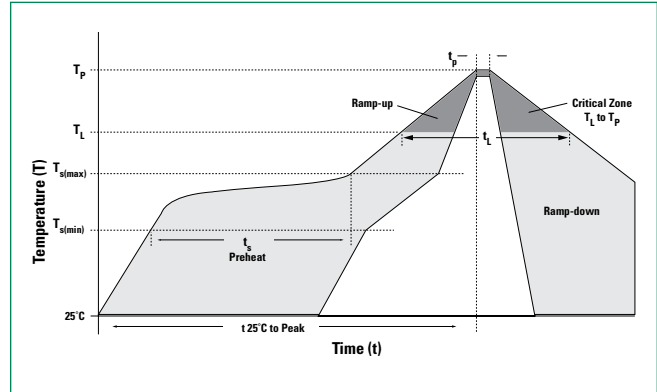

Figure 8 - Peak Forward Voltage Drop vs Peak Forward Current (Typical Values)



Soldering Parameters

Reflow Condition		Pb-Free assembly
Pre Heat	- Temperature Min ($T_{s(min)}$)	150°C
	- Temperature Max ($T_{s(max)}$)	200°C
	- Time (min to max) (t_s)	60 – 120 secs
Average ramp up rate (Liquidus Temp (T_L) to peak)		3°C/second max
$T_{S(max)}$ to T_L - Ramp-up Rate		3°C/second max
Reflow	- Temperature (T_L) (Liquidus)	217°C
	- Time (min to max) (t_L)	60 – 150 seconds
Peak Temperature (T_p)		260 ^{+0/-5} °C
Time within 5°C of actual peak Temperature (t_p)		30 seconds Max
Ramp-down Rate		6°C/second Max
Time 25°C to peak Temperature (T_p)		8 minutes Max.
Do not exceed		260°C



Physical Specifications

Weight	0.003 ounce, 0.093 grams
Case	JEDEC DO214AA. Molded plastic body over glass passivated junction
Polarity	Color band denotes cathode except for bidirectional versions
Terminal	Matte Tin-plated leads, Solderable per JESD22-B102

Environmental Specifications

High Temp. Storage	JESD22-A103
HTRB	JESD22-A108
Temperature Cycling	JESD22-A104
MSL	JEDEC-J-STD-020, Level 1
H3TRB	JESD22-A101
RSH	JESD22-A111

Dimensions

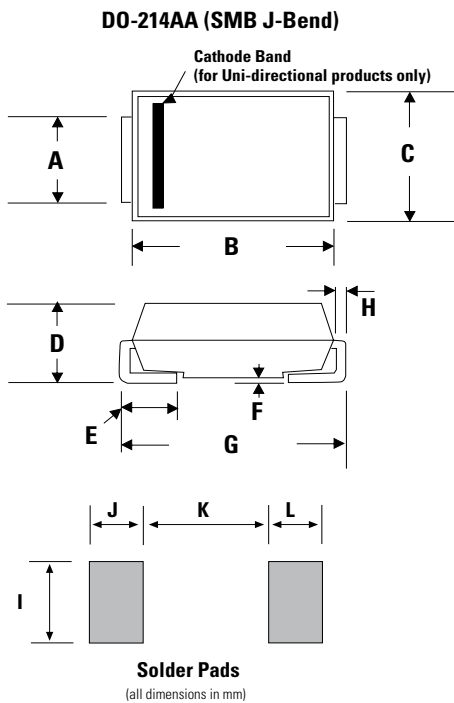

Dimensions	Inches		Millimeters	
	Min	Max	Min	Max
A	0.076	0.086	1.930	2.200
B	0.160	0.187	4.060	4.750
C	0.130	0.155	3.300	3.940
D	0.078	0.103	1.990	2.610
E	0.030	0.060	0.760	1.520
F	-	0.008	-	0.203
G	0.205	0.220	5.210	5.590
H	0.006	0.012	0.152	0.305
I	0.089	-	2.260	-
J	0.085	-	2.160	-
K	-	0.107	-	2.740
L	0.085	-	2.160	-

Part Numbering System

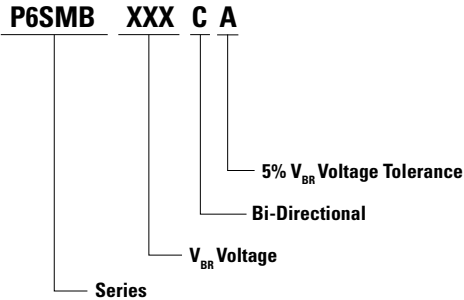

Part Marking System

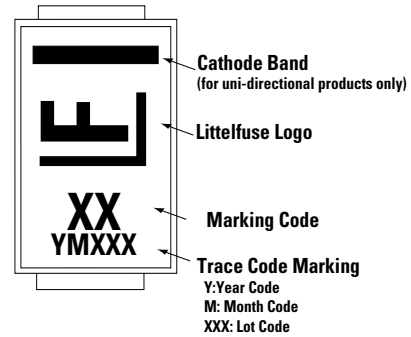

Packaging

Part number	Component Package	Quantity	Packaging Option	Packaging Specification
P6SMBxxxXX	DO-214AA	3000	Tape & Reel - 12mm tape/13" reel	EIA STD RS-481

Tape and Reel Specification

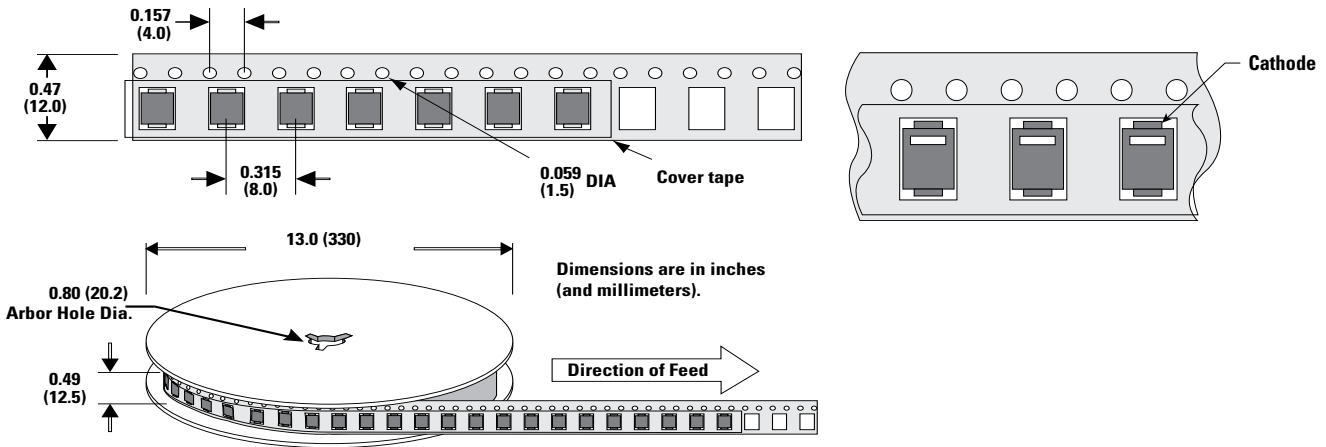

Disclaimer Notice - Information furnished is believed to be accurate and reliable. However, users should independently evaluate the suitability of and test each product selected for their own applications. Littelfuse products are not designed for, and may not be used in, all applications. Read complete Disclaimer Notice at www.littelfuse.com/disclaimer-electronics.

© 2021 Littelfuse, Inc.
Specifications are subject to change without notice.
Revised: BA.06/28/21