

## IRS2111(S)PbF

### HALF-BRIDGE DRIVER

#### Features

- Floating channel designed for bootstrap operation
- Fully operational to +600 V
- Tolerant to negative transient voltage,  $dV/dt$  immune
- Gate drive supply range from 10 V to 20 V
- Undervoltage lockout for both channels
- CMOS Schmitt-triggered inputs with pull-down
- Matched propagation delay for both channels
- Internally set deadtime
- High-side output in phase with input
- RoHS compliant

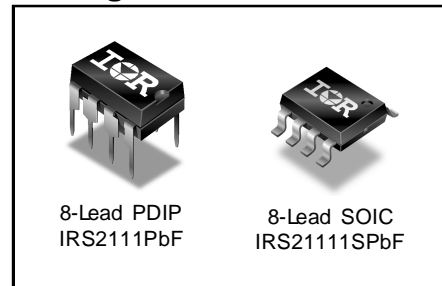
#### Product Summary

$V_{\text{OFFSET}}$	600 V max.
$I_{\text{O}+/-}$	200 mA / 420 mA
$V_{\text{OUT}}$	10 V - 20 V
$t_{\text{on/off}}$ (typ.)	750 ns & 150 ns
Deadtime (typ.)	650 ns

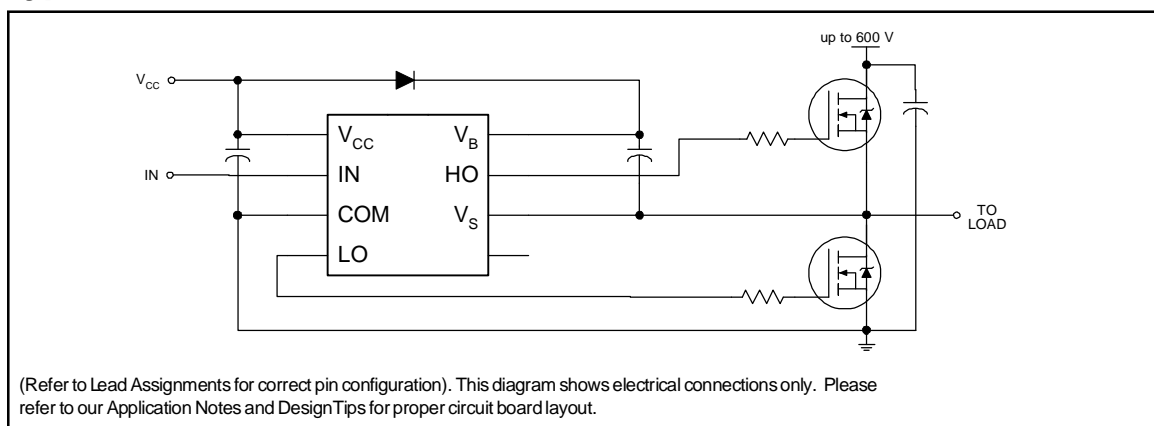
#### Description

The IRS2111 is a high voltage, high speed power MOSFET and IGBT driver with dependent high-side and low-side referenced output channels designed for half-bridge applications. Proprietary HVIC and latch immune CMOS technologies enable ruggedized monolithic construction. Logic input is compatible with standard CMOS outputs. The output drivers feature a high pulse current buffer stage designed for minimum driver cross-conduction. Internal deadtime is provided to avoid shoot-through in the output half-bridge. The floating channel can be used to drive an N-channel power MOSFET or IGBT in the high-side configuration which operates up to 600 V.

#### Packages



#### Typical Connection



## Absolute Maximum Ratings

Absolute maximum ratings indicate sustained limits beyond which damage to the device may occur. All voltage parameters are absolute voltages referenced to COM. The thermal resistance and power dissipation ratings are measured under board mounted and still air conditions. Additional information is shown in Figs. 7 through 10.

Symbol	Definition	Min.	Max.	Units	
$V_B$	High-side floating supply voltage	-0.3	625 (Note 1)	V	
$V_S$	High-side floating supply offset voltage	$V_B - 25$	$V_B + 0.3$		
$V_{HO}$	High-side floating output voltage	$V_S - 0.3$	$V_B + 0.3$		
$V_{CC}$	Low-side and logic fixed supply voltage	-0.3	25 (Note 1)		
$V_{LO}$	Low-side output voltage	-0.3	$V_{CC} + 0.3$		
$V_{IN}$	Logic input voltage	-0.3	$V_{CC} + 0.3$		
$dV_S/dt$	Allowable offset supply voltage transient (Fig. 2)	—	50	V/ns	
$P_D$	Package power dissipation @ $T_A \leq +25\text{ }^\circ\text{C}$	(8 Lead PDIP)	—	1.0	W
		(8 lead SOIC)	—	0.625	
$R_{thJA}$	Thermal resistance, junction to ambient	(8 lead PDIP)	—	125	$^\circ\text{C}/\text{W}$
		(8 lead SOIC)	—	200	
$T_J$	Junction temperature	—	150	$^\circ\text{C}$	
$T_S$	Storage temperature	-55	150		
$T_L$	Lead temperature (soldering, 10 seconds)	—	300		

Note 1: All supplies are fully tested at 25 V, and an internal 20 V clamp exists for each supply

## Recommended Operating Conditions

The input/output logic timing diagram is shown in Fig. 1. For proper operation the device should be used within the recommended conditions. The  $V_S$  offset rating is tested with all supplies biased at a 15 V differential.

Symbol	Definition	Min.	Max.	Units
$V_B$	High-side floating supply absolute voltage	$V_S + 10$	$V_S + 20$	V
$V_S$	High-side floating supply offset voltage	Note 2	600	
$V_{HO}$	High-side floating output voltage	$V_S$	$V_B$	
$V_{CC}$	Low-side and logic fixed supply voltage	10	20	
$V_{LO}$	Low-side output voltage	0	$V_{CC}$	
$V_{IN}$	Logic input voltage	0	$V_{CC}$	
$T_A$	Ambient temperature	-40	125	$^\circ\text{C}$

Note 2: Logic operational for  $V_S$  of -5 V to +600 V. Logic state held for  $V_S$  of -5 V to  $-V_{BS}$ . (Please refer to the Design Tip DT97-3 for more details).

## Dynamic Electrical Characteristics

$V_{BIAS}$  ( $V_{CC}$ ,  $V_{BS}$ ) = 15 V,  $C_L$  = 1000 pF and  $T_A$  = 25 °C unless otherwise specified. The dynamic electrical characteristics are measured using the test circuit shown in Fig. 3.

Symbol	Definition	Min.	Typ.	Max.	Units	Test Conditions
$t_{on}$	Turn-on propagation delay	550	750	950	ns	$V_S = 0$ V
$t_{off}$	Turn-off propagation delay	—	150	180		$V_S = 600$ V
$t_r$	Turn-on rise time	—	75	130		
$t_f$	Turn-off fall time	—	35	65		
DT	Deadtime, LS turn-off to HS turn-on & HS turn-off to LS turn-on	480	650	820		
MT	Delay matching, HS & LS turn-on/off	—	30	—		

## Static Electrical Characteristics

$V_{BIAS}$  ( $V_{CC}$ ,  $V_{BS}$ ) = 15 V and  $T_A$  = 25 °C unless otherwise specified. The  $V_{IN}$ ,  $V_{TH}$ , and  $I_{IN}$  parameters are referenced to COM. The  $V_O$  and  $I_O$  parameters are referenced to COM and are applicable to the respective output leads: HO or LO.

Symbol	Definition	Min.	Typ.	Max.	Units	Test Conditions	
$V_{IH}$	Logic "1" input voltage for HO & logic "0" for LO	6.4	—	—	V	$V_{CC} = 10$ V	
		9.5	—	—		$V_{CC} = 15$ V	
		12.6	—	—		$V_{CC} = 20$ V	
$V_{IL}$	Logic "0" input voltage for HO & logic "1" for LO	—	—	3.8		$V_{CC} = 10$ V	
		—	—	6.0		$V_{CC} = 15$ V	
		—	—	8.3		$V_{CC} = 20$ V	
$V_{OH}$	High level output voltage, $V_{BIAS} - V_O$	—	0.05	0.2			$I_O = 2$ mA
$V_{OL}$	Low level output voltage, $V_O$	—	0.02	0.1			
$I_{LK}$	Offset supply leakage current	—	—	50		$\mu$ A	$V_B = V_S = 600$ V
$I_{QBS}$	Quiescent $V_{BS}$ supply current	—	50	100	$V_{IN} = 0$ V or $V_{CC}$		
$I_{QCC}$	Quiescent $V_{CC}$ supply current	—	70	180	$V_{IN} = V_{CC}$		
$I_{IN+}$	Logic "1" input bias current	—	30	50	$V_{IN} = 0$ V		
$I_{IN-}$	Logic "0" input bias current	—	—	5.0			
$V_{BSUV+}$	$V_{BS}$ supply undervoltage positive going threshold	7.6	8.6	9.6	V		
$V_{BSUV-}$	$V_{BS}$ supply undervoltage negative going threshold	7.2	8.2	9.2			
$V_{CCUV+}$	$V_{CC}$ supply undervoltage positive going threshold	7.6	8.6	9.6			
$V_{CCUV-}$	$V_{CC}$ supply undervoltage negative going threshold	7.2	8.2	9.2			
$I_{O+}$	Output high short circuit pulsed current	200	290	—	mA	$V_O = 0$ V, $V_{IN} = V_{CC}$ $PW \leq 10$ $\mu$ s	
$I_{O-}$	Output low short circuit pulsed current	420	600	—		$V_O = 15$ V, $V_{IN} = 0$ V $PW \leq 10$ $\mu$ s	

## Functional Block Diagram



## Lead Definitions

Symbol	Description
IN	Logic input for high-side and low-side gate driver outputs (HO & LO), in phase with HO
V <sub>B</sub>	High-side floating supply
HO	High-side gate drive output
V <sub>S</sub>	High-side floating supply return
V <sub>CC</sub>	Low-side and logic fixed supply
LO	Low-side gate drive output
COM	Low-side return

## Lead Assignments

<p>8 Lead DIP</p> <p><b>IRS2111</b></p>	<p>8 Lead SOIC</p> <p><b>IRS2111S</b></p>
<b>Part Number</b>	

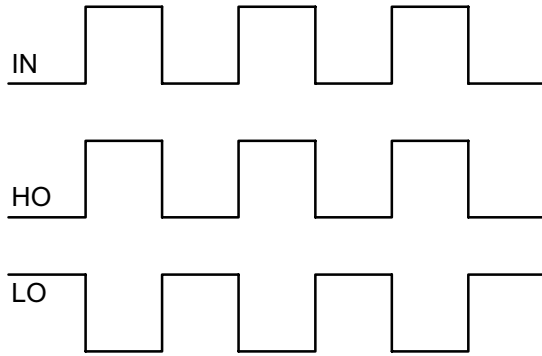


Figure 1. Input/Output Timing Diagram

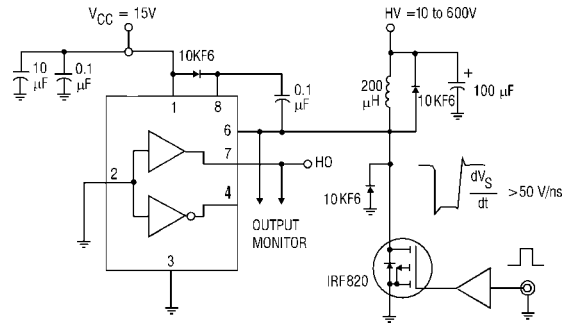


Figure 2. Floating Supply Voltage Transient Test Circuit

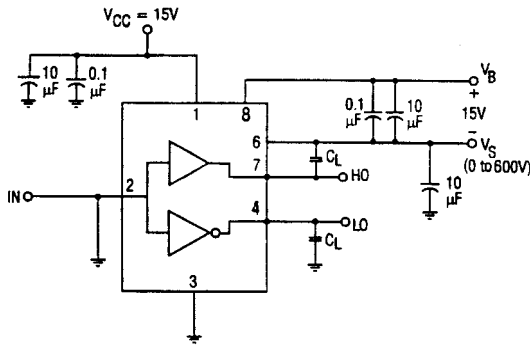


Figure 3. Switching Time Test Circuit

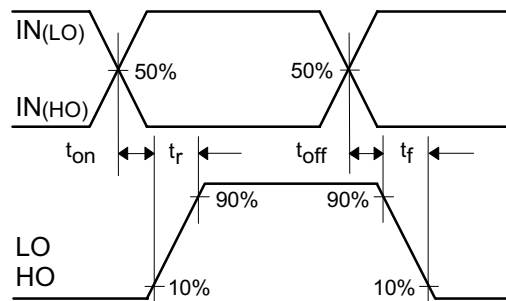


Figure 4. Switching Time Waveform Definition

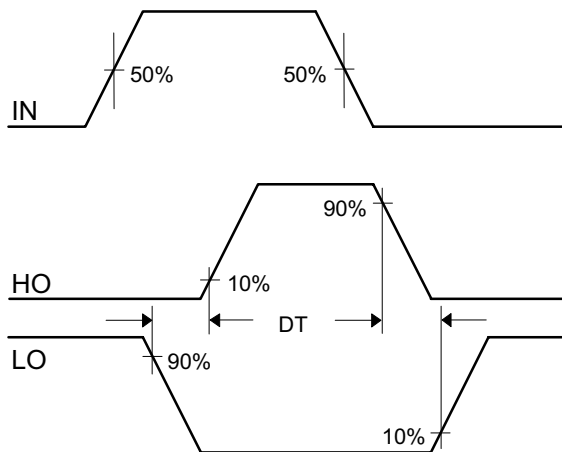


Figure 5. Deadtime Waveform Definitions

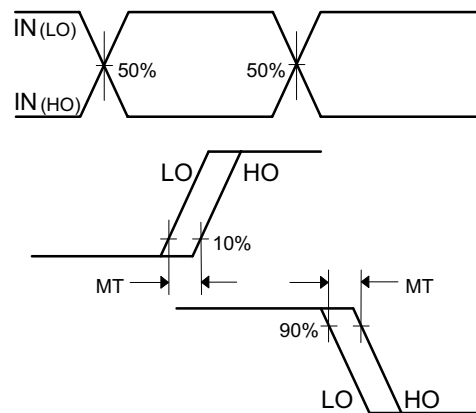


Figure 6. Delay Matching Waveform Definitions

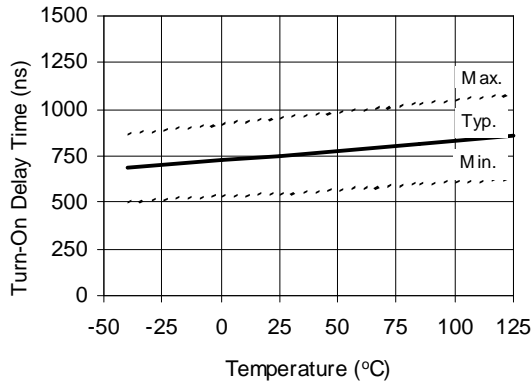


Figure 7A Turn-On Time vs Temperature

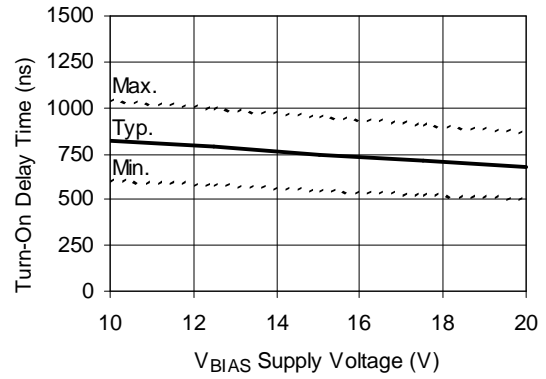


Figure 7B Turn-On Time vs Voltage

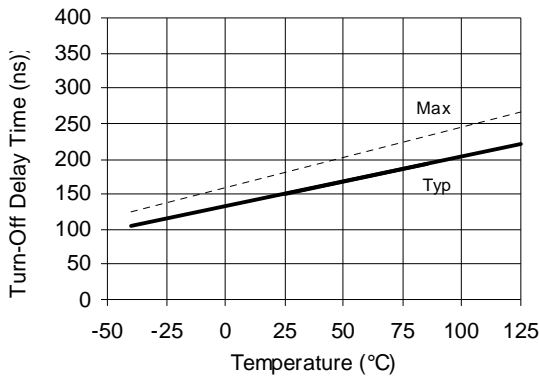


Figure 8A Turn-Off Time vs Temperature

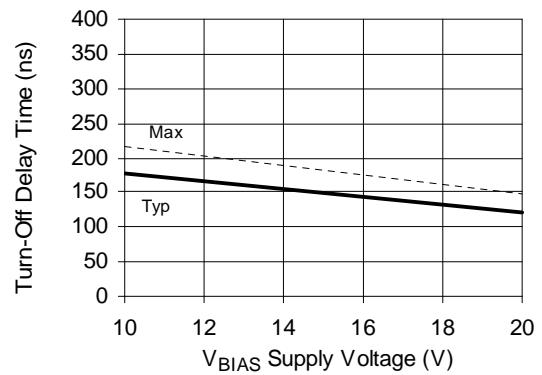


Figure 8B Turn-Off Time vs Voltage

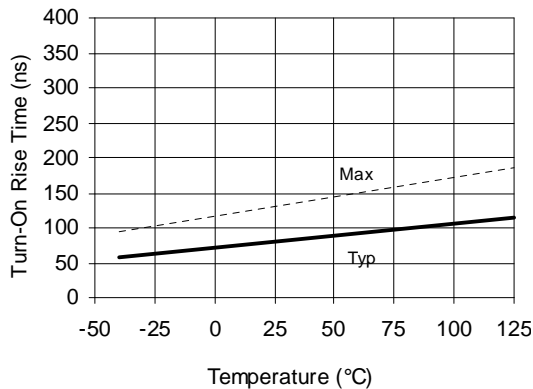


Figure 9A Turn-On Rise Time vs Temperature

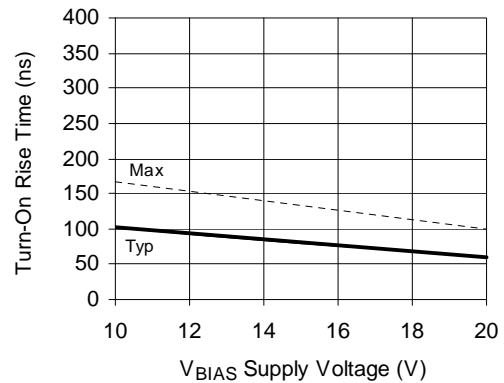


Figure 9B Turn-On Rise Time vs Voltage

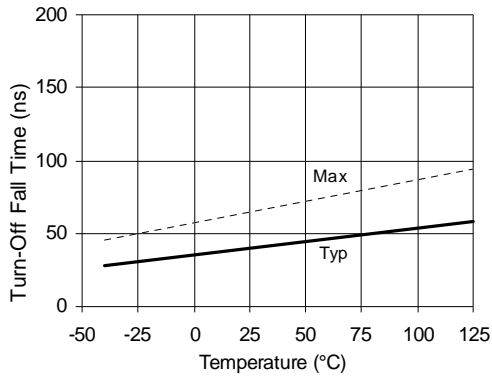


Figure 10A Turn-Off Fall Time vs Temperature

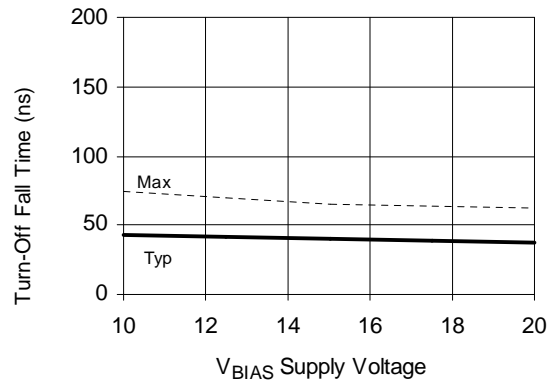


Figure 10B Turn-Off Fall Time vs Voltage

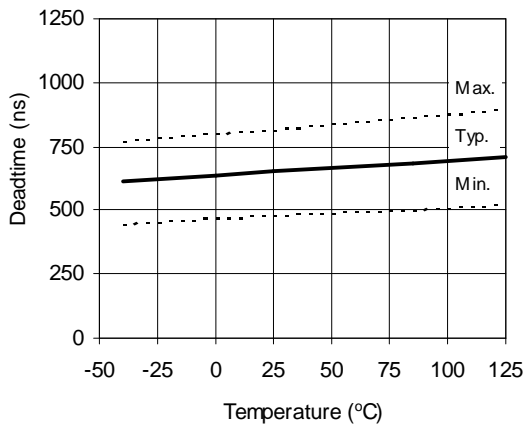


Figure 11A Deadtime vs Temperature

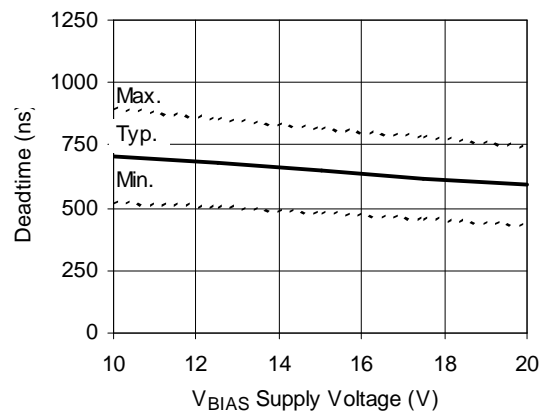


Figure 11B Deadtime vs Voltage

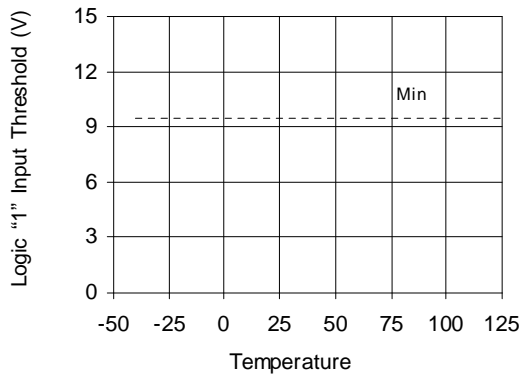


Figure 12A Logic "1" Input voltage for HO & Logic "0" for LO vs Temperature

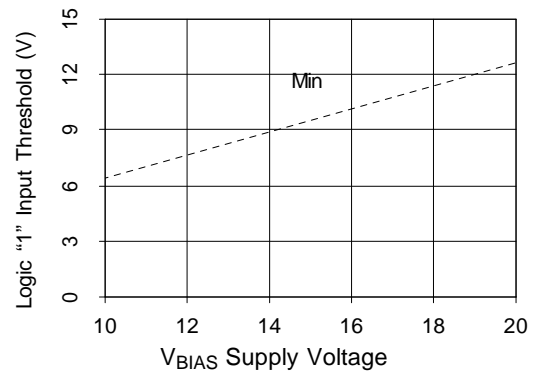
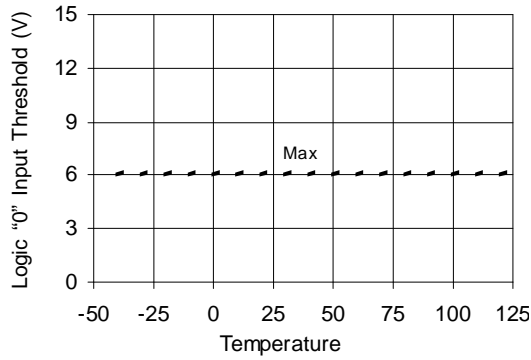
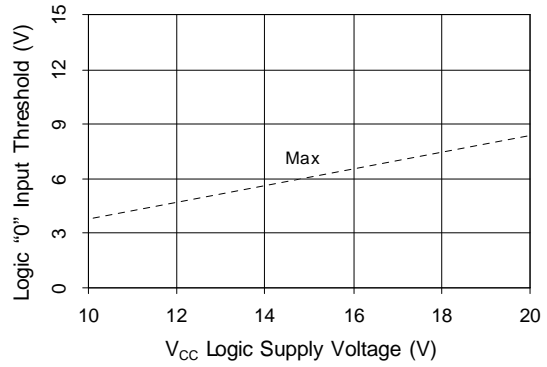


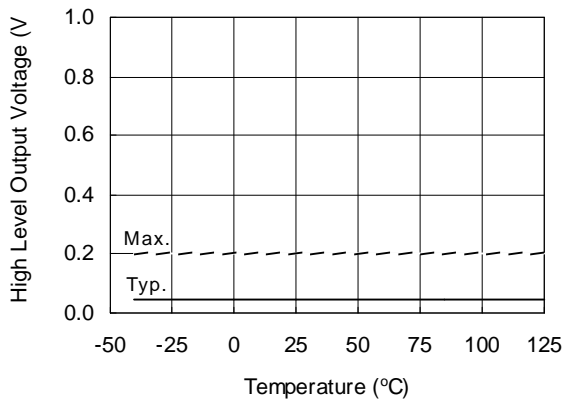
Figure 12B Logic "1" Input voltage for HO & Logic "0" for LO vs Voltage



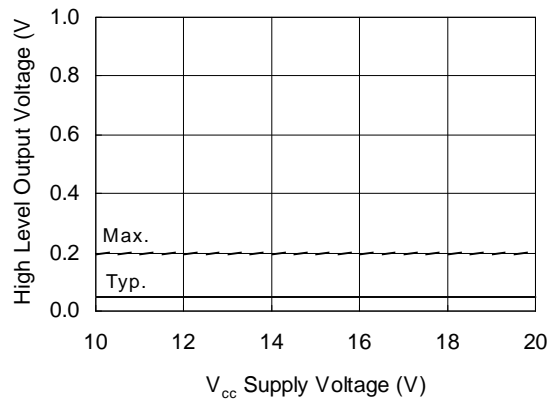
**Figure 13A** Logic "0" Input voltage for HO & Logic "1" for LO vs Temperature



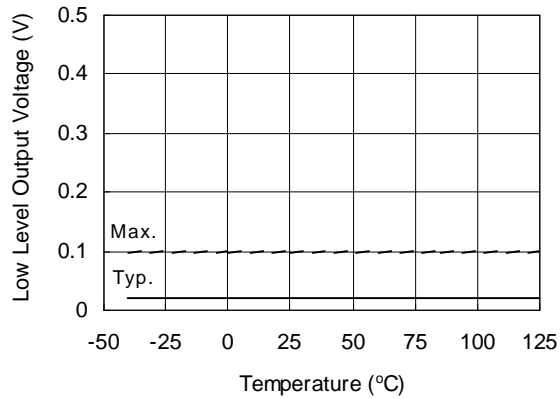
**Figure 13B** Logic "0" Input voltage for HO & Logic "1" for LO vs Voltage



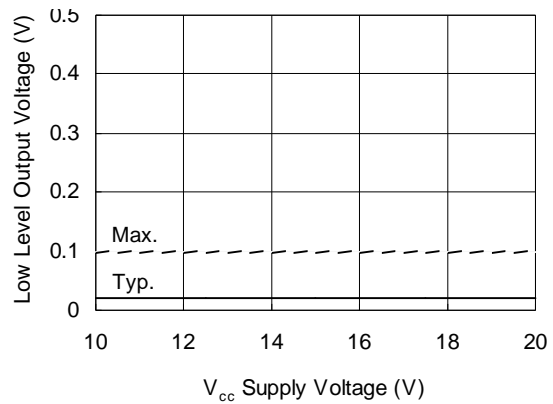
**Figure 14A.** High Level Output vs. Temperature



**Figure 14B.** High Level Output vs. Supply Voltage

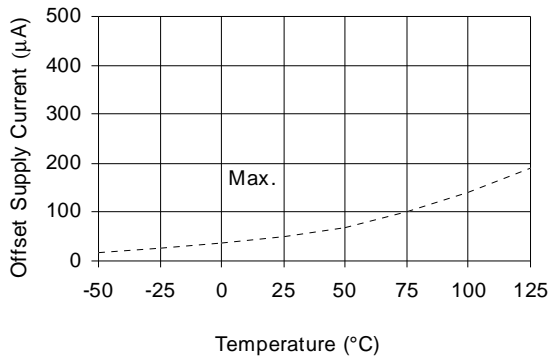


**Figure 15A.** Low Level Output vs. Temperature

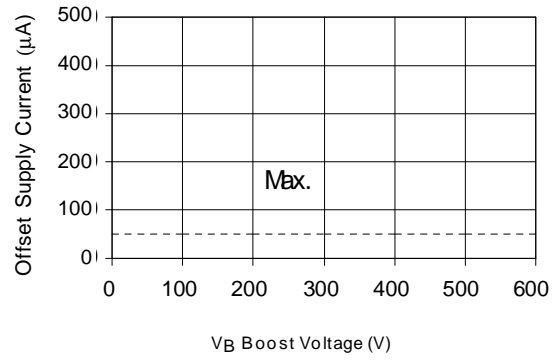


**Figure 15B.** Low Level Output vs. Voltage

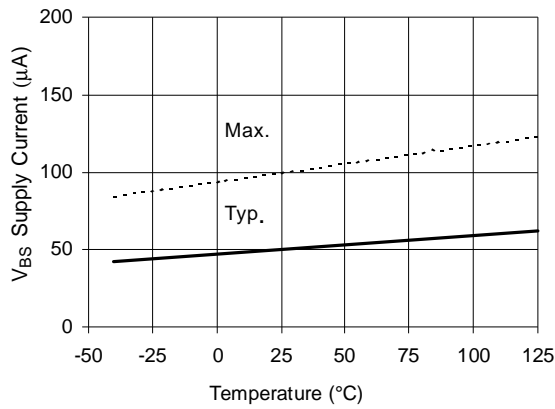




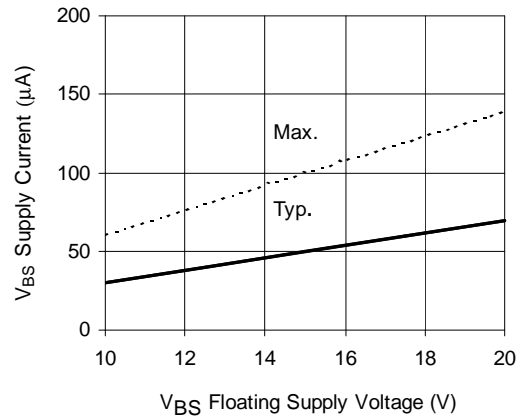
**Figure 16A Offset Supply Current vs Temperature**



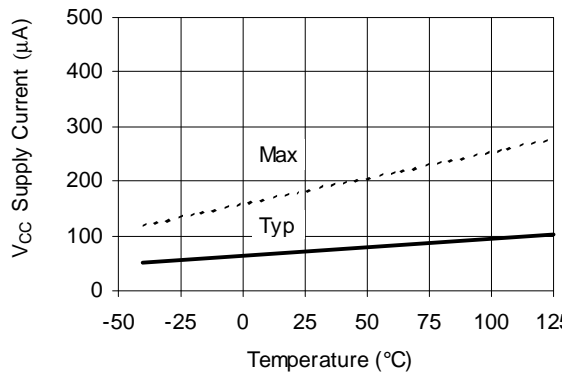
**Figure 16B Offset Supply Current vs Voltage**



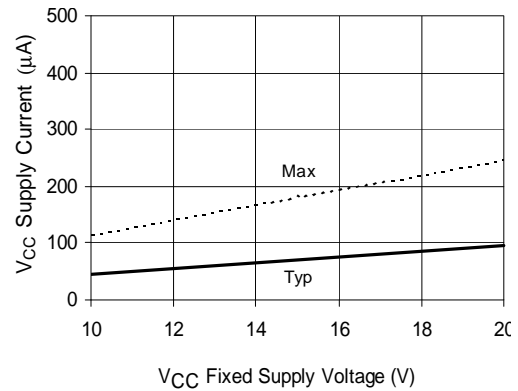
**Figure 17A V<sub>BS</sub> Supply Current vs Temperature**



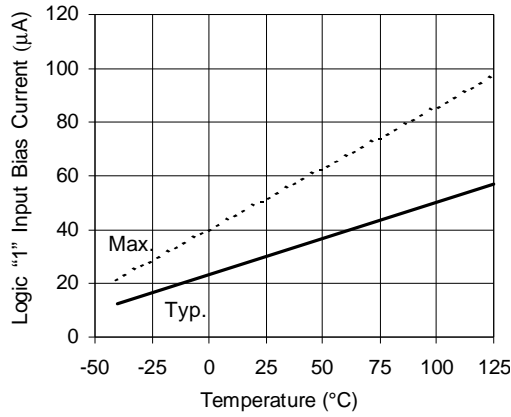
**Figure 17B V<sub>BS</sub> Supply Current vs Voltage**



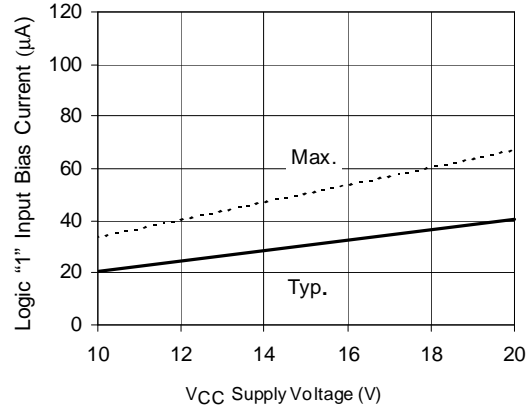
**Figure 18A V<sub>CC</sub> Supply Current vs Temperature**



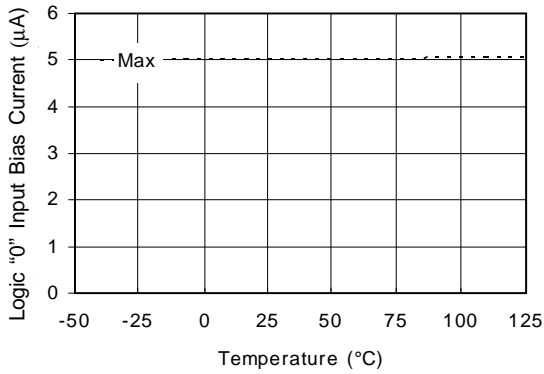
**Figure 18B V<sub>CC</sub> Supply Current vs Voltage**



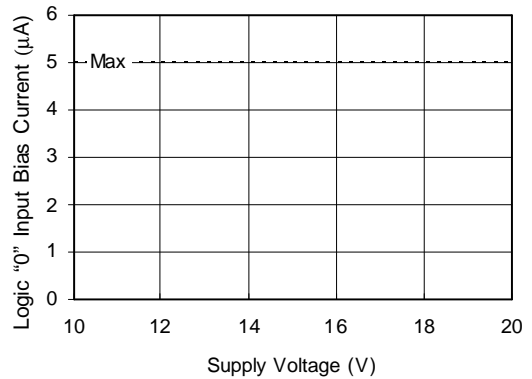
**Figure 19A Logic "1" Input Current vs. Temperature**



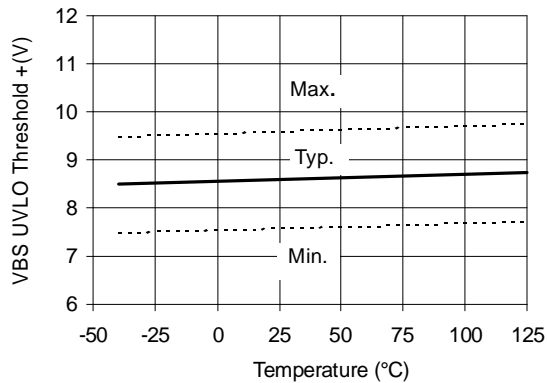
**Figure 19B Logic "1" Input Current vs. V<sub>CC</sub> Voltage**



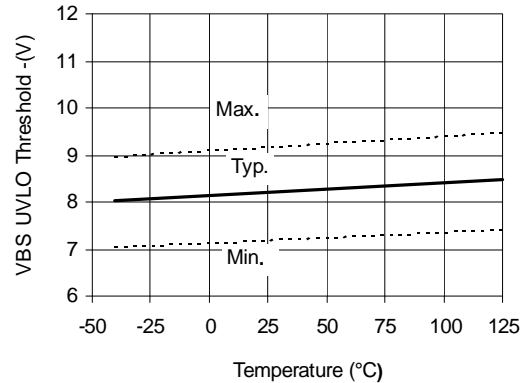
**Figure 20A. Logic "0" Input Bias Current vs. Temperature**



**Figure 20B. Logic "0" Input Bias Current vs. V<sub>CC</sub> Voltage**



**Figure 21 V<sub>BS</sub> Undervoltage Threshold (+) vs. Temperature**



**Figure 22 V<sub>BS</sub> Undervoltage Threshold (-) vs. Temperature**

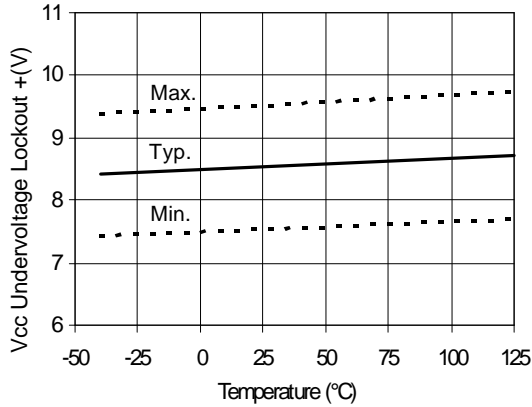


Figure 23 V<sub>CC</sub> Undervoltage (-) vs Temperature

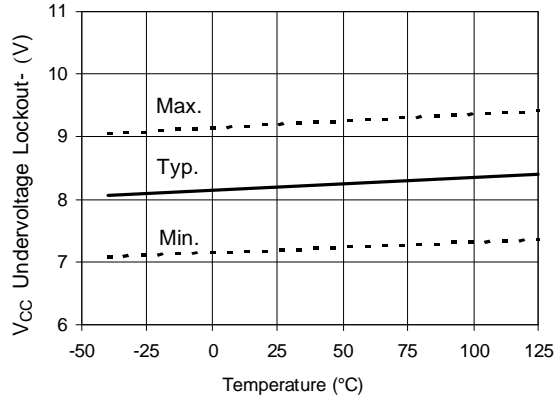


Figure 24 V<sub>CC</sub> Undervoltage (-) vs Temperature

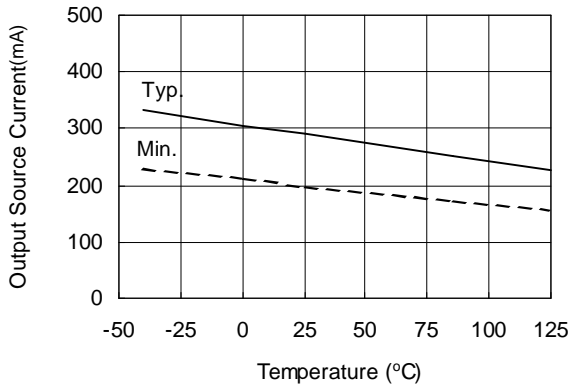


Figure 25A Output Source Current vs Temperature

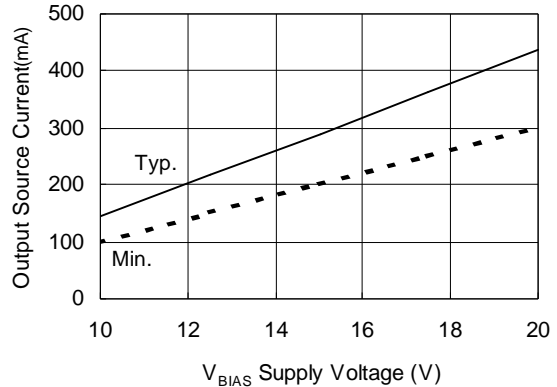


Figure 25B Output Source Current vs Voltage

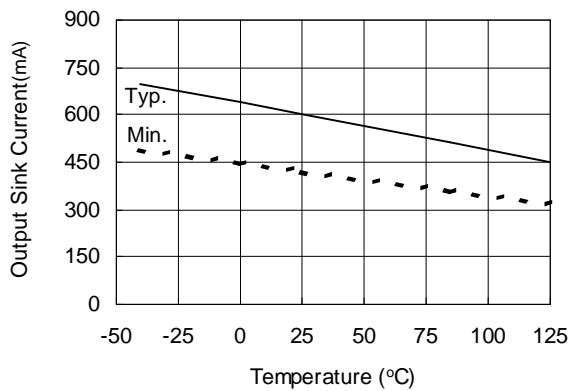


Figure 26A Output Sink Current vs Temperature

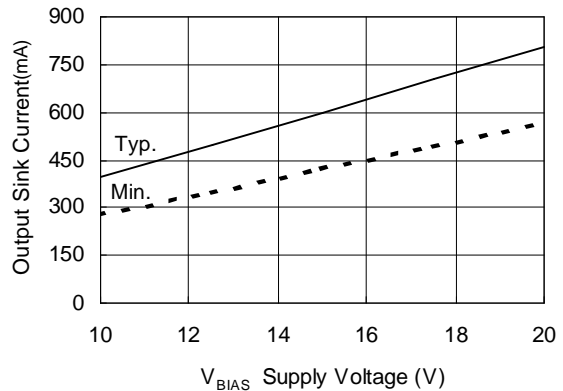
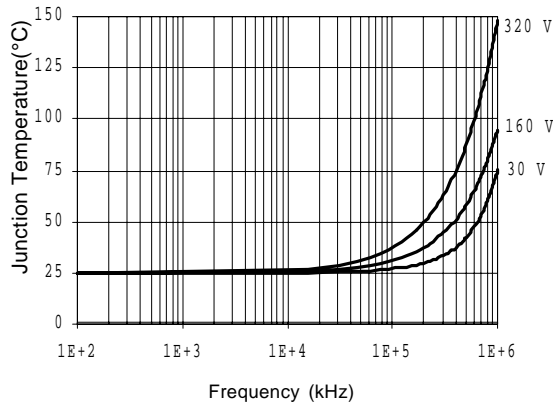
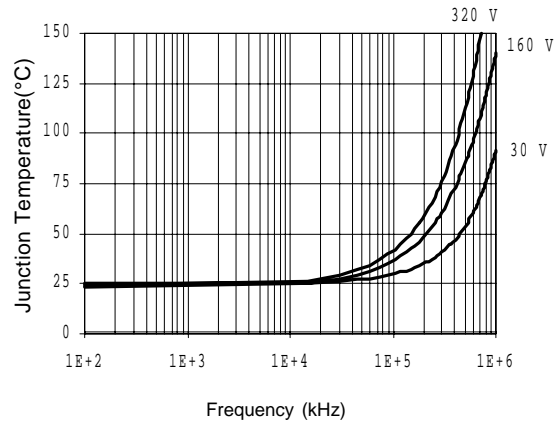


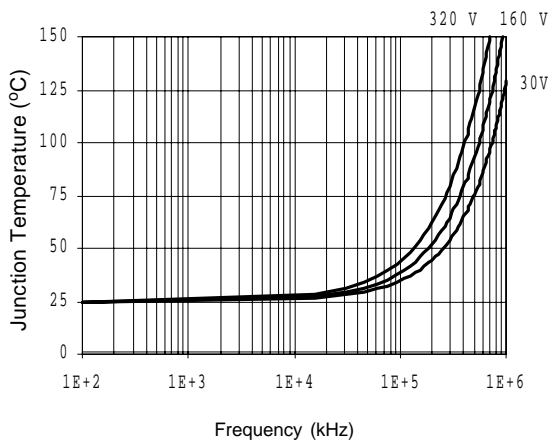
Figure 26B Output Sink Current vs Voltage



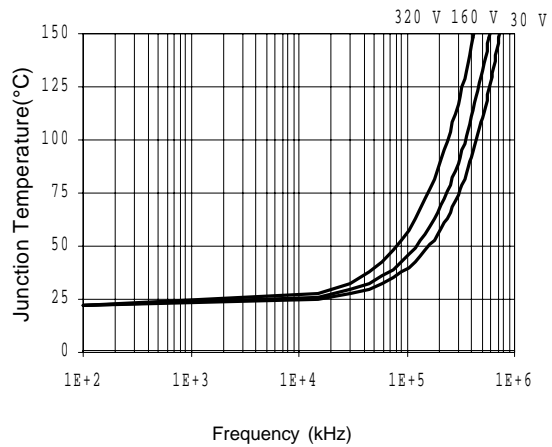
**Figure 27. IRS2111 TJ vs. Frequency (IRFBC20)**  
**R<sub>GATE</sub> = 33 Ω, V<sub>CC</sub> = 15 V**



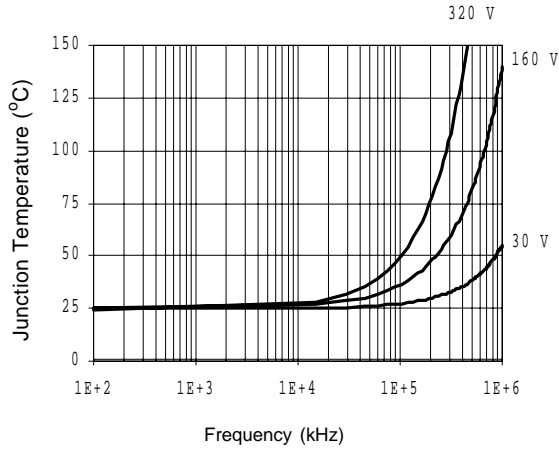
**Figure 28. IRS2111 TJ vs. Frequency (IRFBC30)**  
**R<sub>GATE</sub> = 22 Ω, V<sub>CC</sub> = 15 V**



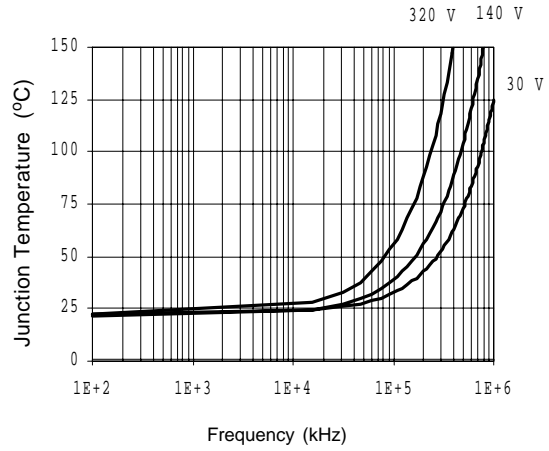
**Figure 29. IRS2111 TJ vs. Frequency (IRFBC40)**  
**R<sub>GATE</sub> = 15 Ω, V<sub>CC</sub> = 15 V**



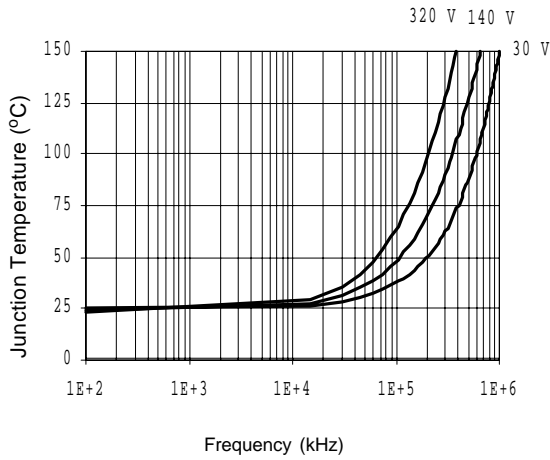
**Figure 30. IRS2111 TJ vs. Frequency (IRFPC50)**  
**R<sub>GATE</sub> = 10 Ω, V<sub>CC</sub> = 15 V**



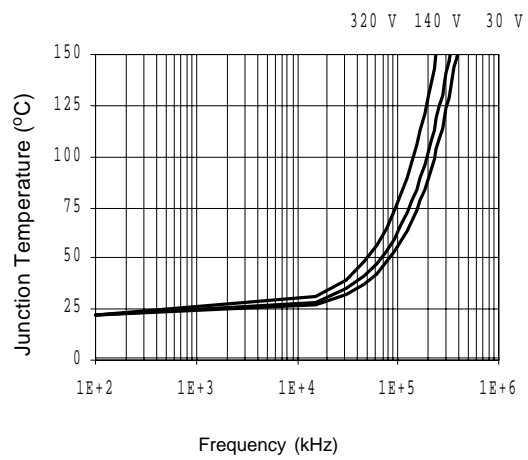
**Figure 31. IRS2111S TJ vs. Frequency (IRFBC20)**  
 $R_{GATE} = 33 \Omega, V_{CC} = 15 V$



**Figure 32. IRS2111S TJ vs. Frequency (IRFBC30)**  
 $R_{GATE} = 22 \Omega, V_{CC} = 15 V$

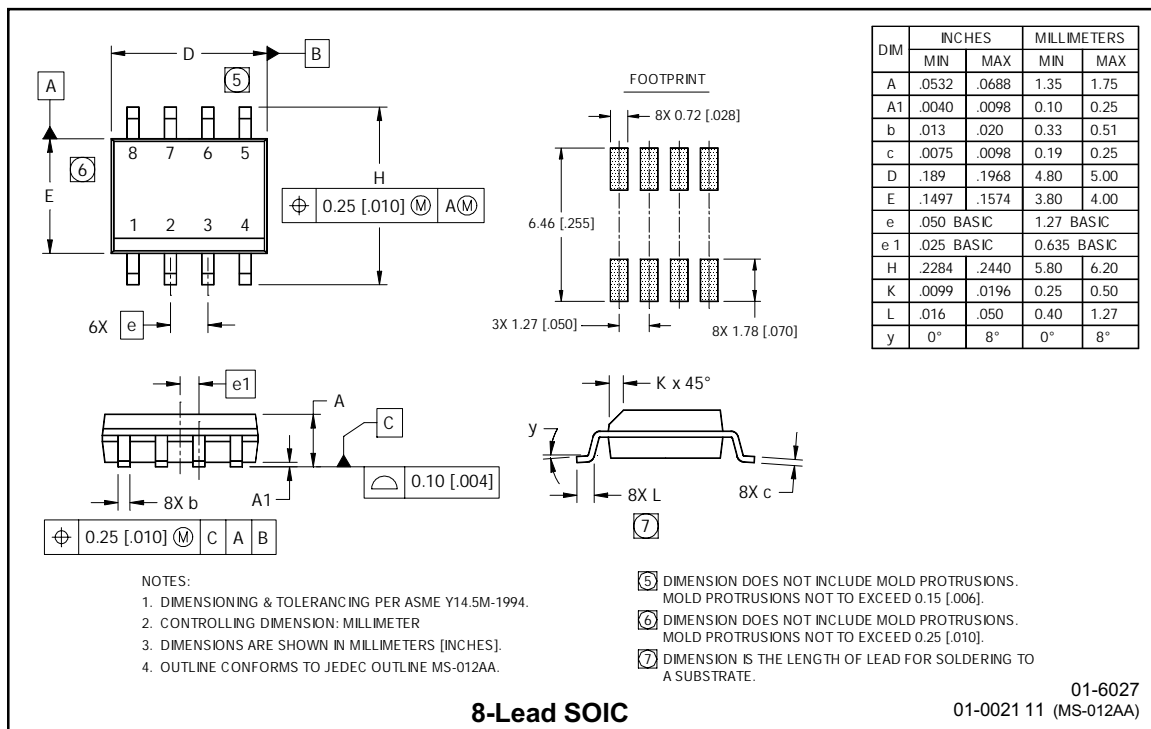
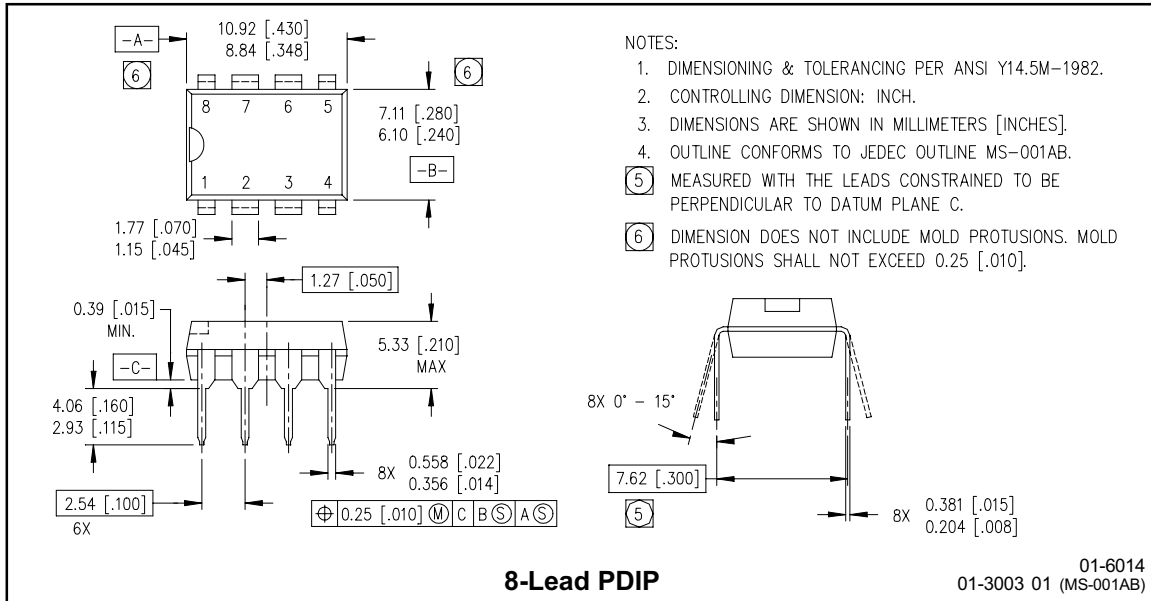


**Figure 33. IRS2111S TJ vs. Frequency (IRFBC40)**  
 $R_{GATE} = 15 \Omega, V_{CC} = 15 V$

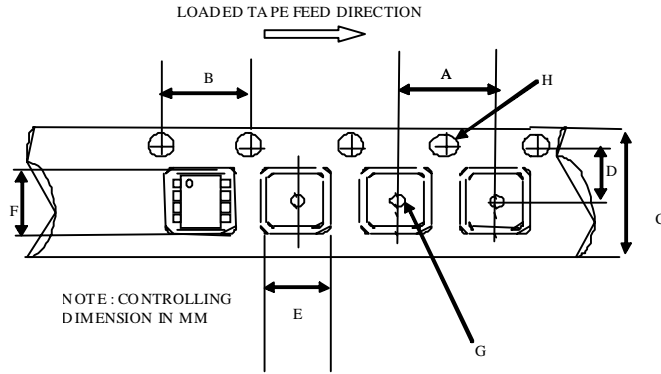


**Figure 34. IRS2111S TJ vs. Frequency (IRFPC50)**  
 $R_{GATE} = 10 \Omega, V_{CC} = 15 V$

## Case outlines

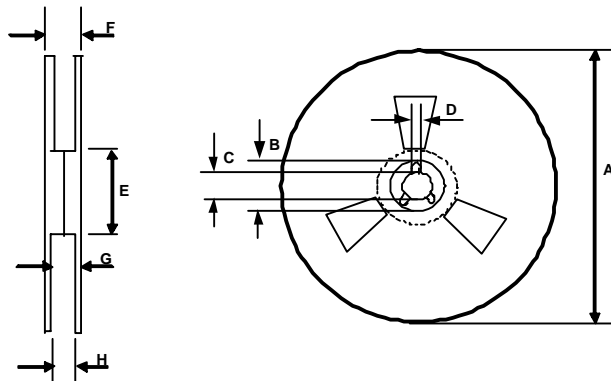


## Tape & Reel 8-lead SOIC



CARRIER TAPE DIMENSION FOR 8SOICN

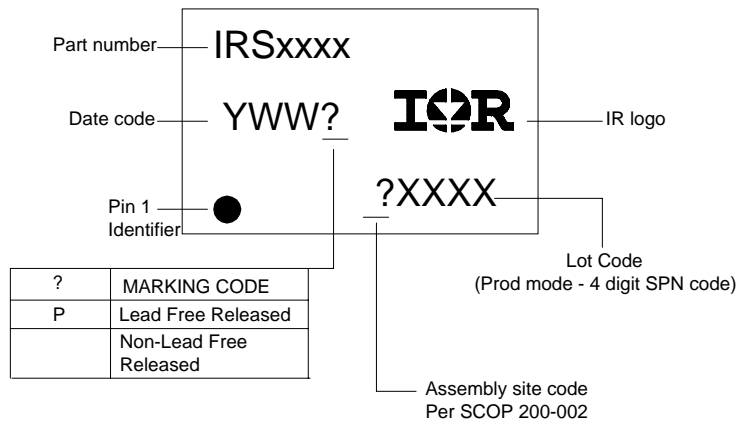
Code	Metric		Imperial	
	Min	Max	Min	Max
A	7.90	8.10	0.311	0.318
B	3.90	4.10	0.153	0.161
C	11.70	12.30	0.46	0.484
D	5.45	5.55	0.214	0.218
E	6.30	6.50	0.248	0.255
F	5.10	5.30	0.200	0.208
G	1.50	n/a	0.059	n/a
H	1.50	1.60	0.059	0.062



REEL DIMENSIONS FOR 8SOICN

Code	Metric		Imperial	
	Min	Max	Min	Max
A	329.60	330.25	12.976	13.001
B	20.95	21.45	0.824	0.844
C	12.80	13.20	0.503	0.519
D	1.95	2.45	0.767	0.096
E	98.00	102.00	3.858	4.015
F	n/a	18.40	n/a	0.724
G	14.50	17.10	0.570	0.673
H	12.40	14.40	0.488	0.566

## LEADFREE PART MARKING INFORMATION



## ORDER INFORMATION

- 8-Lead PDIP IRS2111PbF
- 8-Lead SOIC IRS2111SPbF
- 8-Lead SOIC Tape & Reel IRS2111STRPbF



# Mouser Electronics

Authorized Distributor

Click to View Pricing, Inventory, Delivery & Lifecycle Information:

[Infineon:](#)

[IRS2111PBF](#) [IRS2111STRPBF](#) [IRS2111SPbF](#)