

## CDSUR400-HF

$I_o = 100\text{mA}$

$V_R = 80\text{ Volts}$

RoHS Device

Halogen Free

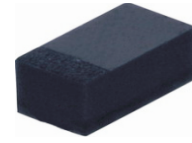

### Features

- High Speed.
- Designed for mounting on small surface.
- Extremely thin/leadless package.
- Low leakage current.
- High mounting capability, strong surge withstand, high reliability.

### Mechanical data

- Case: 0603/SOD-523F standard package, molded plastic.
- Terminals: Gold plated, Solderable per MIL-STD-750, method 2026.
- Polarity: Indicated by cathode band.
- Mounting position: Any.
- Weight: 0.003 grams(approx.).

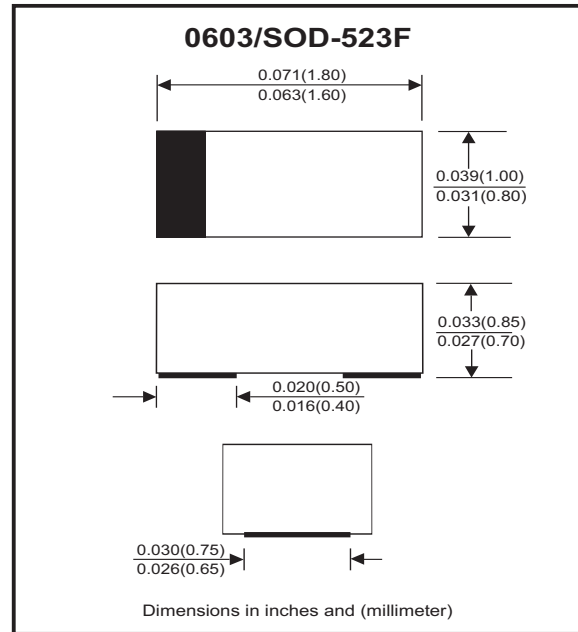

### Circuit diagram



### Maximum Rating (at $T_A=25\text{ }^\circ\text{C}$ unless otherwise noted)

Parameter	Conditions	Symbol	Min	Typ	Max	Unit
Repetitive peak reverse voltage		$V_{RRM}$			90	V
Reverse voltage		$V_R$			80	V
Average forward current		$I_o$			100	mA
Forward current, surge peak	8.3 ms single half sine-wave superimposed on rate load (JEDEC method)	$I_{FSM}$		1000		mA
Power dissipation		$P_D$			400	mW
Thermal resistance	Junction to ambient	$R_{\theta JA}$			250	$^\circ\text{C/W}$
Operating temperature range		$T_j$	-40		+125	$^\circ\text{C}$
Storage temperature range		$T_{STG}$	-55		+125	$^\circ\text{C}$

### Electrical Characteristics (at $T_A=25\text{ }^\circ\text{C}$ unless otherwise noted)

Parameter	Conditions	Symbol	Min	Typ	Max	Unit
Forward voltage	$I_F = 100\text{ mA DC}$	$V_F$			1.0	V
Reverse current	$V_R = 80\text{V}$	$I_R$			0.1	$\mu\text{A}$
Capacitance between terminals	$f = 1\text{MHz}$ , and $0.5\text{V DC}$ reverse voltage	$C_T$		3		pF
Reverse recovery time	$V_R = 6\text{V}$ , $I_F = 10\text{mA}$ , $R_L = 50\text{ ohms}$	$T_{rr}$		4		nS

## RATING AND CHARACTERISTIC CURVES (CDSUR400-HF)

Fig.1 - Forward Characteristics

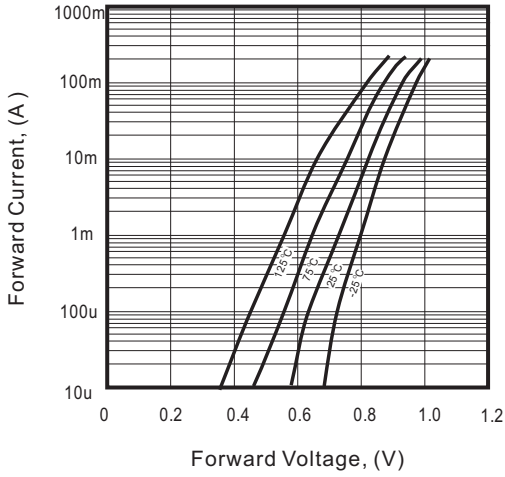

Fig.2 - Reverse Characteristics

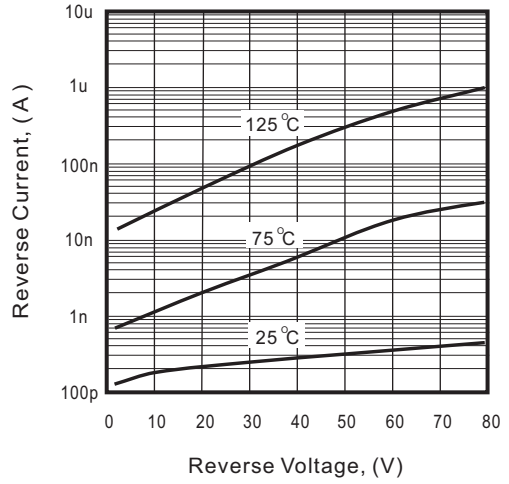

Fig.3 - Capacitance Between Terminals Characteristics

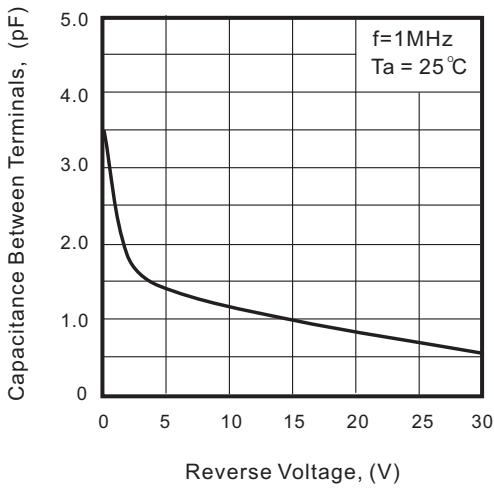
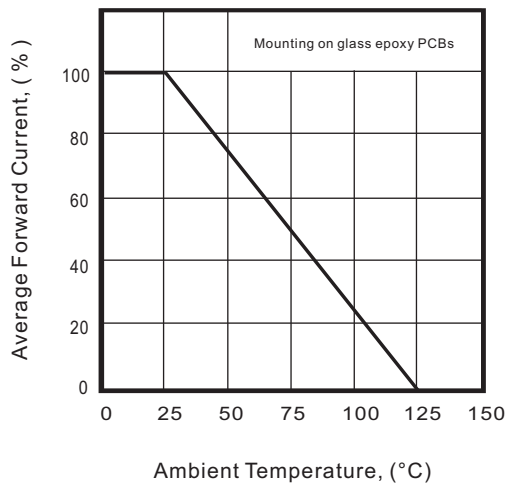
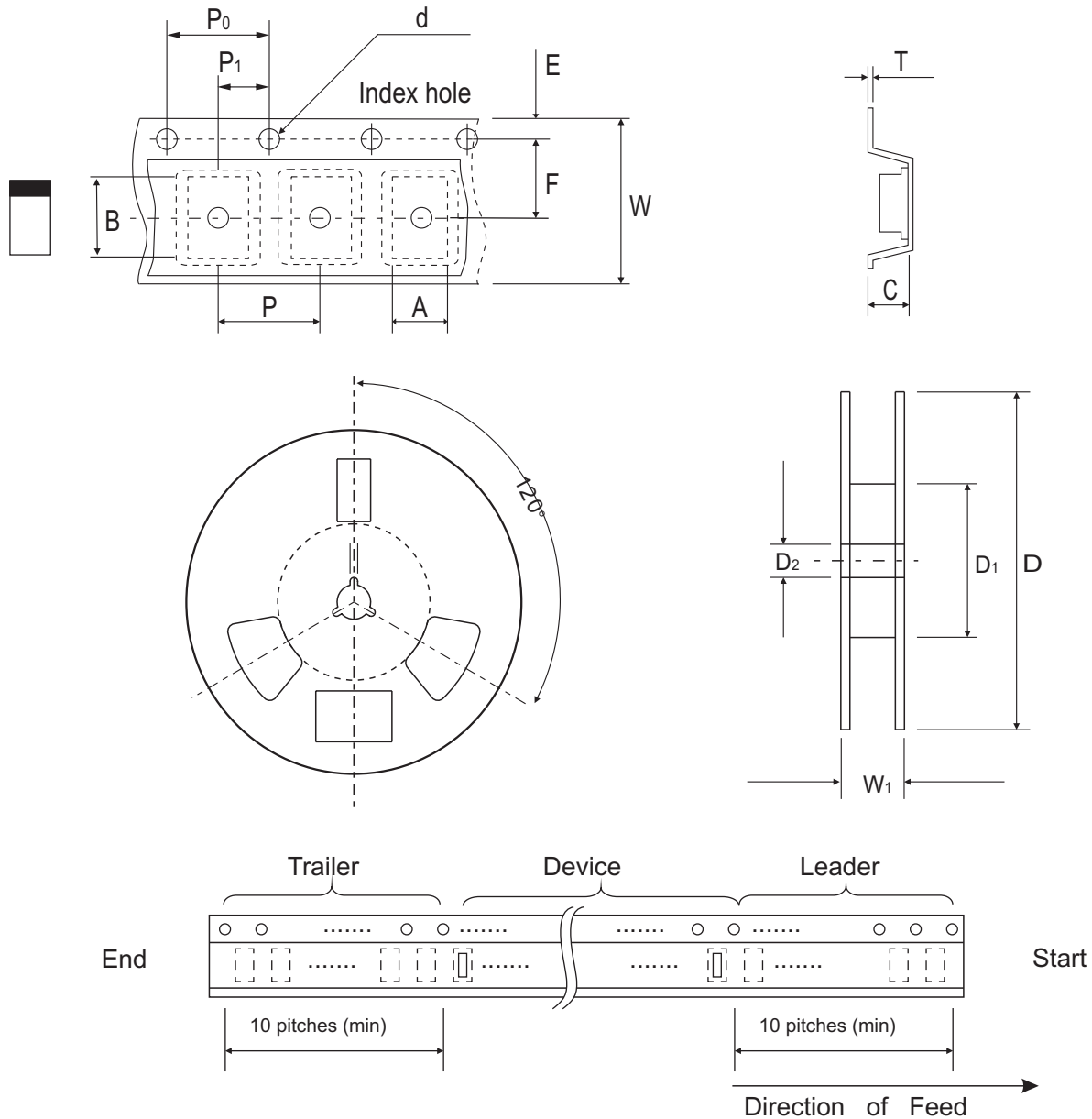

Fig.4 - Current Derating Curve



## Reel Taping Specification



0603 (SOD-523)	SYMBOL	A	B	C	d	D	D <sub>1</sub>	D <sub>2</sub>
	(mm)	1.00 ± 0.10	1.85 ± 0.10	1.00 ± 0.10	1.55 ± 0.05	178 ± 1	60.0 MIN.	13.0 ± 0.20
	(inch)	0.039 ± 0.004	0.073 ± 0.004	0.039 ± 0.004	0.061 ± 0.002	7.008 ± 0.04	2.362 MIN.	0.512 ± 0.008

0603 (SOD-523)	SYMBOL	E	F	P	P <sub>0</sub>	P <sub>1</sub>	T	W	W <sub>1</sub>
	(mm)	1.75 ± 0.10	3.50 ± 0.05	4.00 ± 0.10	4.00 ± 0.10	2.00 ± 0.05	0.23 ± 0.05	8.00 ± 0.20	13.5 MAX.
	(inch)	0.069 ± 0.004	0.138 ± 0.002	0.157 ± 0.004	0.157 ± 0.004	0.079 ± 0.004	0.009 ± 0.002	0.315 ± 0.008	0.531 MAX.

## Marking Code

Part Number	Marking Code
CDSUR400-HF	S1



## Suggested PAD Layout

SIZE	0603/SOD-523F	
	(mm)	(inch)
A	1.25	0.049
B	0.60	0.024
C	1.00	0.039
D	1.85	0.073
E	0.65	0.026

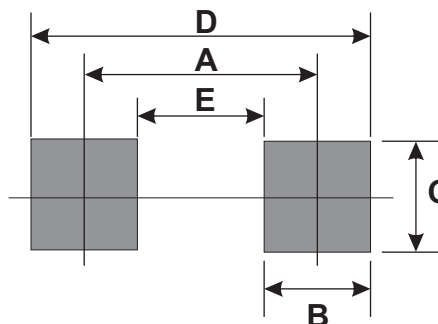

## Standard Packaging

Case Type	Qty Per Reel	Reel Size
	(Pcs)	(inch)
0603/SOD-523F	4,000	7

# Mouser Electronics

Authorized Distributor

Click to View Pricing, Inventory, Delivery & Lifecycle Information:

[Comchip Technology:](#)

[CDSUR400](#)