

**NPN PRE-BIASED SMALL SIGNAL DUAL SURFACE MOUNT TRANSISTOR**
**Features**

- Epitaxial Planar Die Construction
- Complementary PNP Types Available (DDA)
- Built-In Biasing Resistors
- **Totally Lead-Free & Fully RoHS Compliant (Notes 1 & 2)**
- **Halogen and Antimony Free. "Green" Device (Note 3)**
- **The DDC (XXXX) UQs are suitable for automotive applications requiring specific change control; these parts are AEC-Q101 qualified, PPAP capable, and manufactured in IATF 16949 certified facilities.**

<https://www.diodes.com/quality/product-definitions/>

**Mechanical Data**

- Package: SOT363
- Package Material: Molded Plastic, "Green" Molding Compound. UL Flammability Classification Rating 94V-0
- Moisture Sensitivity: Level 1 per J-STD-020
- Terminals: Finish – Matte Tin Plated Leads, Solderable per MIL-STD-202, Method 208 ③
- Weight: 0.006 grams (Approximate)

Part Number	R1 (NOM)	R2 (NOM)
DDC124EU	22kΩ	22kΩ
DDC144EU	47kΩ	47kΩ
DDC114YU	10kΩ	47kΩ
DDC123JU	2.2kΩ	47kΩ
DDC114EU	10kΩ	10kΩ
DDC143XU	4.7kΩ	10kΩ
DDC143ZU	4.7kΩ	47kΩ
DDC115EU	100kΩ	100kΩ

Part Number	R1 Only
DDC113TU	1kΩ
DDC143TU	4.7kΩ
DDC114TU	10kΩ

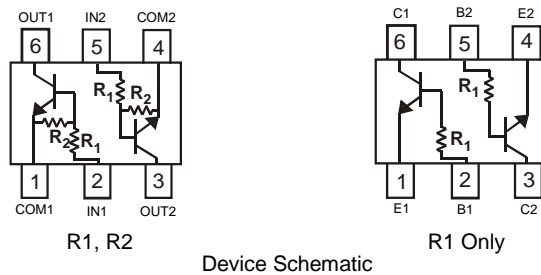
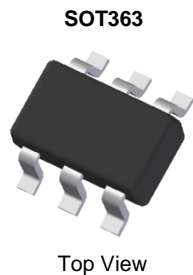

**Ordering Information** (Notes 4, 5)

Part Number	Status	Marking	Reel Size (inches)	Tape Width (mm)	Quantity per Reel
DDC124EU-7-F	Active	N17	7	8	3,000
DDC124EUQ-7-F	NRND (Use <a href="#">ADC124EUQ</a> )	N17	7	8	3,000
DDC144EU-7-F	Active	N20	7	8	3,000
DDC114YU-7-F	Active	N14	7	8	3,000
DDC114YUQ-7-F	NRND (Use <a href="#">ADC114YUQ</a> )	N14	7	8	3,000
DDC114YUQ-13-F	NRND (Use <a href="#">ADC114YUQ</a> )	N14	13	8	10,000
DDC123JU-7-F	Active	N06	7	8	3,000
DDC114EU-7-F	Active	N13	7	8	3,000
DDC114EUQ-7-F	NRND (Use <a href="#">ADC114EUQ</a> )	N13	7	8	3,000
DDC114EUQ-13-F	NRND (Use <a href="#">ADC114EUQ</a> )	N13	13	8	10,000
DDC113TU-7-F	Active	N01	7	8	3,000
DDC143TU-7-F	Active	N07	7	8	3,000
DDC114TU-7-F	Active	N12	7	8	3,000
DDC114TUQ-7-F	Active	N12	7	8	3,000
DDC143XU-7	Active	N04	7	8	3,000
DDC143XU-13	Active	N04	13	8	10,000
DDC143ZU-7-F	Active	N03	7	8	3,000
DDC115EU-7-F	Active	N02	7	8	3,000

- Notes:
1. No purposely added lead. Fully EU Directive 2002/95/EC (RoHS), 2011/65/EU (RoHS 2) & 2015/863/EU (RoHS 3) compliant.
  2. See <https://www.diodes.com/quality/lead-free/> for more information about Diodes Incorporated's definitions of Halogen- and Antimony-free, "Green" and Lead-free.
  3. Halogen- and Antimony-free "Green" products are defined as those which contain <900ppm bromine, <900ppm chlorine (<1500ppm total Br + Cl) and <1000ppm antimony compounds.
  4. For packaging details, go to our website at <https://www.diodes.com/design/support/packaging/diodes-packaging/>.
  5. NRND = Not Recommended for New Design.

## Marking Information

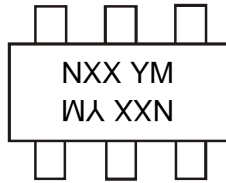
SOT363



NXX = Product Type Marking Code (See Ordering Information)  
 YM = Date Code Marking  
 Y or  $\bar{Y}$  = Year (ex: J = 2022)  
 M = Month (ex: 9 = September)

Date Code Key

Year	2002	....	2022	2023	2024	2025	2026	2027	2028	2029	2030	2031
Code	O	....	J	K	L	M	N	O	P	R	S	T

Month	Jan	Feb	Mar	Apr	May	Jun	Jul	Aug	Sep	Oct	Nov	Dec
Code	1	2	3	4	5	6	7	8	9	O	N	D

## Absolute Maximum Ratings (@ $T_A = +25^\circ\text{C}$ , unless otherwise specified.)

Characteristic		Symbol	Value	Unit
Supply Voltage		$V_O$	50	V
Input Voltage	DDC124EU	$V_I$	-10 to +40	V
	DDC144EU		-10 to +40	
	DDC114YU		-6 to +40	
	DDC123JU		-5 to +12	
	DDC114EU		-10 to +40	
	DDC113TU		-5V max	
	DDC143TU		-5V max	
	DDC114TU		-5V max	
	DDC143XU		-7 to +20	
Output Current	DDC143ZU	$I_O$	-5 to +30	mA
	DDC115EU		-10 to +40	
	DDC124EU		30	
	DDC144EU		30	
	DDC114YU		70	
	DDC123JU		100	
	DDC114EU		50	
	DDC113TU		100	
	DDC143TU		100	
Peak Output Current	DDC114TU	$I_{CM}$	100	mA
	DDC143XU		100	
	DDC143ZU		100	
	DDC115EU		20	
			100	

## Thermal Characteristics (@ $T_A = +25^\circ\text{C}$ , unless otherwise specified.)

Characteristic	Symbol	Value	Unit
Power Dissipation (Notes 6 & 7)	$P_D$	200	mW
Thermal Resistance, Junction to Ambient Air (Note 6)	$R_{\theta JA}$	625	$^\circ\text{C}/\text{W}$
Operating and Storage Temperature Range	$T_J, T_{STG}$	-55 to +150	$^\circ\text{C}$

Notes: 6. Mounted on FR-4 PC Board with minimum recommended pad layout.  
 7. 150mW per element must not be exceeded.

**Electrical Characteristics** (@ T<sub>A</sub> = +25°C, unless otherwise specified.)  
**For R1 Only Devices: DDC113TU & DDC143TU & DDC114TU**

Characteristic	Symbol	Min	Typ	Max	Unit	Test Condition
Collector-Base Breakdown Voltage	BV <sub>CBO</sub>	50	—	—	V	I <sub>C</sub> = 50μA
Collector-Emitter Breakdown Voltage	BV <sub>CEO</sub>	50	—	—	V	I <sub>C</sub> = 1mA
Emitter-Base Breakdown Voltage	BV <sub>EBO</sub>	5	—	—	V	I <sub>E</sub> = 50μA
Collector Cutoff Current	I <sub>CBO</sub>	—	—	0.5	μA	V <sub>CB</sub> = 50V
Emitter Cutoff Current	I <sub>EBO</sub>	—	—	0.5	μA	V <sub>EB</sub> = 4V
Collector-Emitter Saturation Voltage	V <sub>CE(sat)</sub>	—	—	0.3	V	I <sub>C</sub> /I <sub>B</sub> = 2.5mA / 0.25mA DDC143TU
						I <sub>C</sub> /I <sub>B</sub> = 1mA / 0.1mA DDC114TU
						I <sub>C</sub> /I <sub>B</sub> = 10mA / 1mA DDC113TU
DC Current Transfer Ratio	h <sub>FE</sub>	100	250	600	—	I <sub>C</sub> = 1mA, V <sub>CE</sub> = 5V
Input Resistor (R <sub>1</sub> ) Tolerance	ΔR <sub>1</sub>	-30	—	+30	%	—
Transition frequency (Note 8)	f <sub>T</sub>	—	250	—	MHZ	V <sub>CE</sub> = 10V, I <sub>E</sub> = -5mA, f = 100MHZ

**Electrical Characteristics** (@ T<sub>A</sub> = +25°C, unless otherwise specified.)  
**For R1, R2 Devices: DDC124EU & DDC144EU & DDC114YU & DDC123JU & DDC114EU & DDC143ZU & DDC115EU**

Characteristic	Symbol	Min	Typ	Max	Unit	Test Condition	
Input Voltage	V <sub>I(off)</sub>	0.5	1.1	—	V	V <sub>CC</sub> = 5V, I <sub>O</sub> = 100μA	
		DDC124EU	0.5				1.1
		DDC144EU	0.3				—
		DDC114YU	0.5				—
		DDC123JU	0.5				1.1
		DDC114EU	0.3				—
		DDC143XU	0.5				—
		DDC143ZU	0.5				—
	V <sub>I(on)</sub>	—	1.9	3.0	V	V <sub>O</sub> = 0.3V, I <sub>O</sub> = 5mA	
		DDC124EU	1.9	3.0			
		DDC144EU	—	1.4			
		DDC114YU	—	1.1			
		DDC123JU	1.9	3.0			
		DDC114EU	—	2.5			
Output Voltage	V <sub>O(on)</sub>	—	0.1	0.3	V	I <sub>O</sub> /I <sub>I</sub> = 10mA / 0.5mA	
		DDC124EU	—	0.1			0.3
		DDC144EU	—	0.1			0.3
		DDC114YU	—	0.1			0.3
		DDC123JU	—	0.1			0.3
		DDC114EU	—	0.1			0.3
		DDC143XU	—	0.1			0.3
		DDC143ZU	—	0.1			0.3
Input Current	I <sub>I</sub>	—	—	0.36	mA	V <sub>I</sub> = 5V	
		DDC124EU	—	—			0.18
		DDC144EU	—	—			0.88
		DDC114YU	—	—			3.6
		DDC123JU	—	—			0.88
		DDC114EU	—	—			1.8
		DDC143XU	—	—			1.8
		DDC143ZU	—	—			0.15
Output Current	I <sub>O(off)</sub>	—	—	0.5	μA	V <sub>CC</sub> = 50V, V <sub>I</sub> = 0V	
DC Current Gain	G <sub>I</sub>	56	—	—	—	V <sub>O</sub> = 5V, I <sub>O</sub> = 5mA	
		DDC124EU				68	V <sub>O</sub> = 5V, I <sub>O</sub> = 5mA
		DDC144EU				68	V <sub>O</sub> = 5V, I <sub>O</sub> = 10mA
		DDC114YU				80	V <sub>O</sub> = 5V, I <sub>O</sub> = 5mA
		DDC114YUQ				80	V <sub>O</sub> = 5V, I <sub>O</sub> = 10mA
		DDC123JU				30	V <sub>O</sub> = 5V, I <sub>O</sub> = 5mA
		DDC114EU				30	V <sub>O</sub> = 5V, I <sub>O</sub> = 10mA
		DDC143XU				80	V <sub>O</sub> = 5V, I <sub>O</sub> = 10mA
		DDC143ZU				82	V <sub>O</sub> = 5V, I <sub>O</sub> = 5mA
		DDC115EU				82	V <sub>O</sub> = 5V, I <sub>O</sub> = 5mA
Input Resistor (R <sub>1</sub> ) Tolerance	ΔR <sub>1</sub>	-30	—	+30	%	—	
Resistance Ratio Tolerance	Δ(R <sub>2</sub> /R <sub>1</sub> )	-20	—	+20	%	—	
Transition frequency (Note 8)	f <sub>T</sub>	—	250	—	MHZ	V <sub>CE</sub> = 10V, I <sub>E</sub> = 5mA, f = 100MHZ	

Note: 8. Transistor - for reference only.

**DDC(XXXX)U**

Document number: DS30345 Rev. 20 - 2

**Typical Curves – DDC123JU** (@  $T_A = +25^\circ\text{C}$ , unless otherwise specified.)

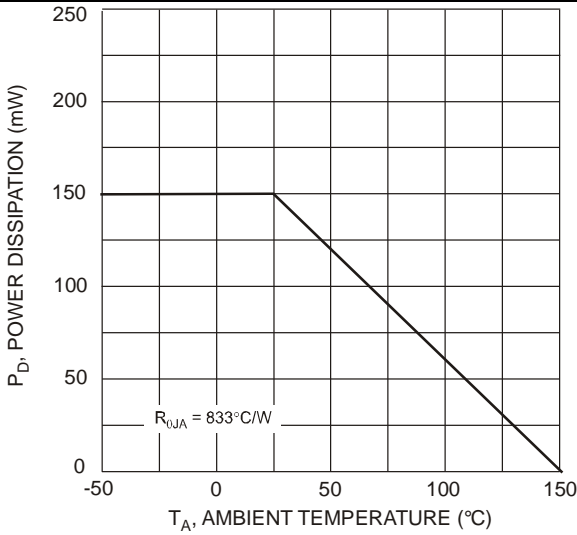

**$P_D$  v  $T_A$**

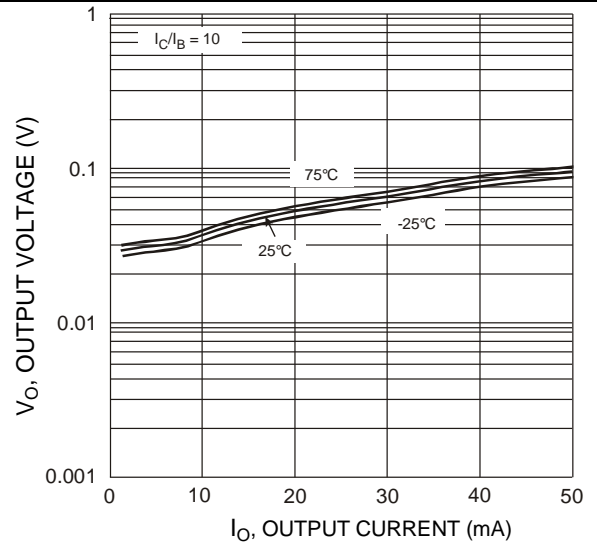

**$V_O$  v  $I_O$**

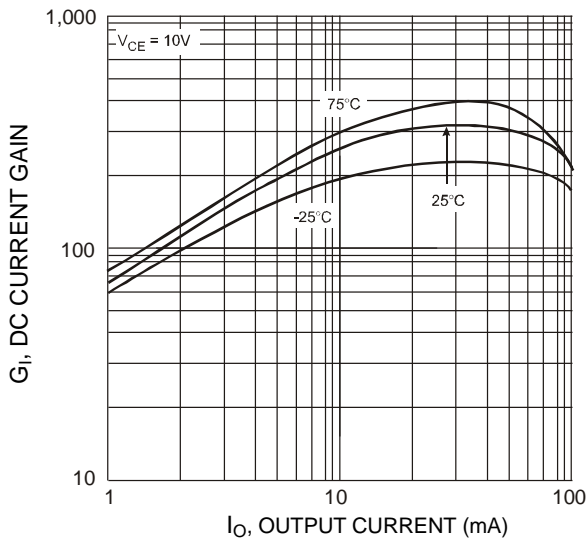

**$G_I$  v  $I_O$**

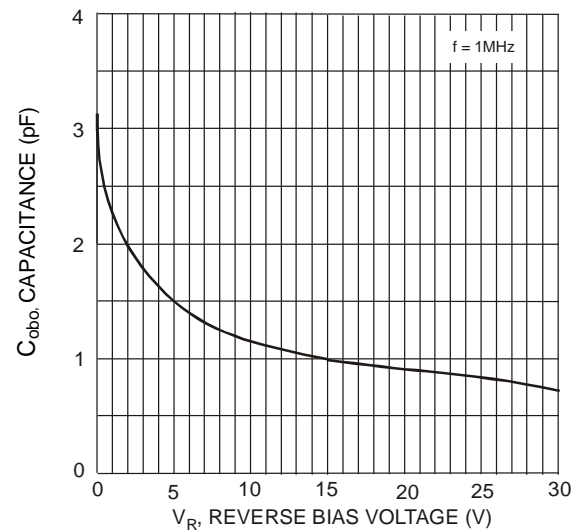

**$C_{obo}$  v  $V_R$**

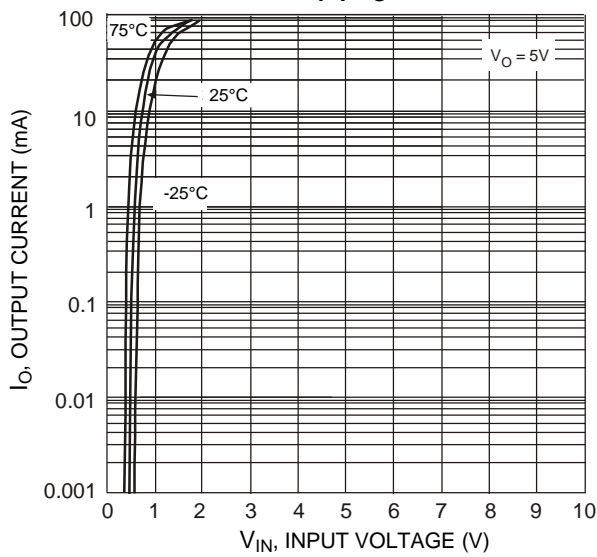

**$I_O$  v  $V_{IN}$**

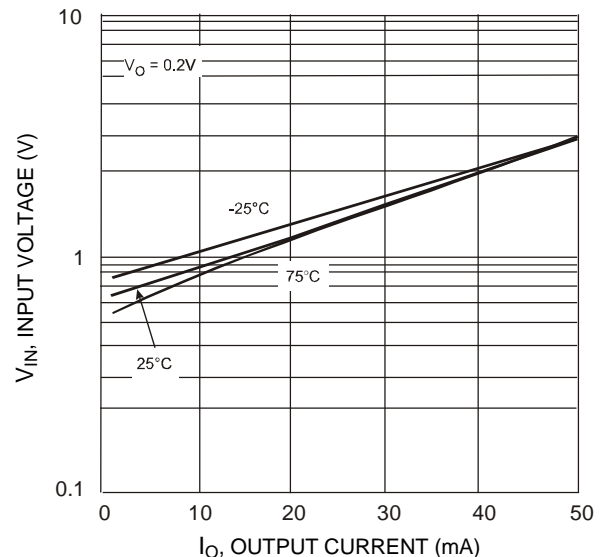

**$V_{IN}$  v  $I_O$**

**Typical Curves – DDC114YU** (@  $T_A = +25^\circ\text{C}$ , unless otherwise specified.)

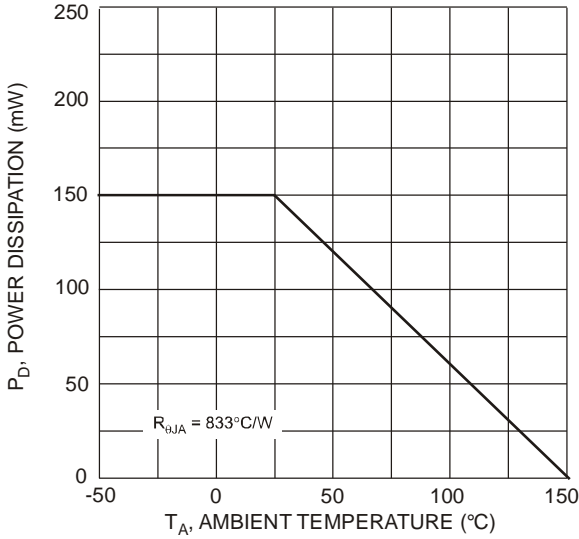

**$P_D$  v  $T_A$**

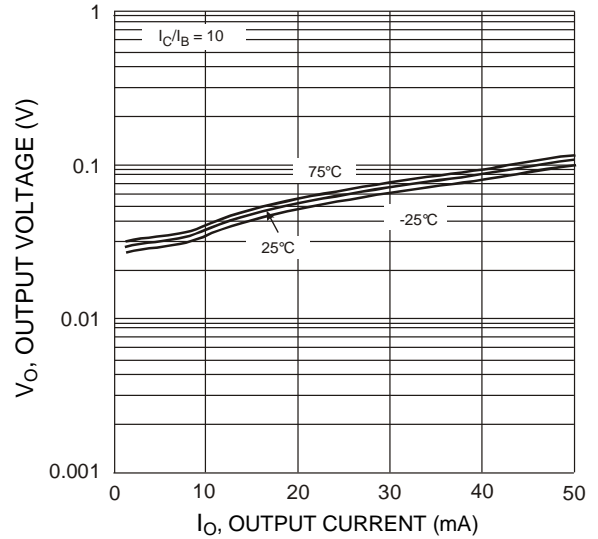

**$V_O$  v  $I_O$**

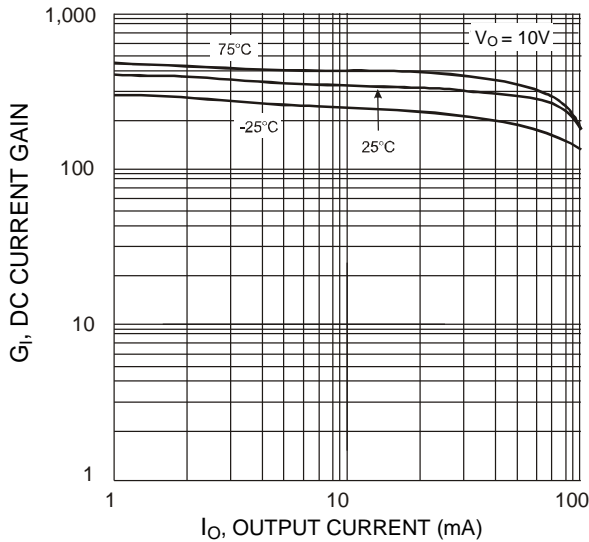

**$G_I$  v  $I_O$**

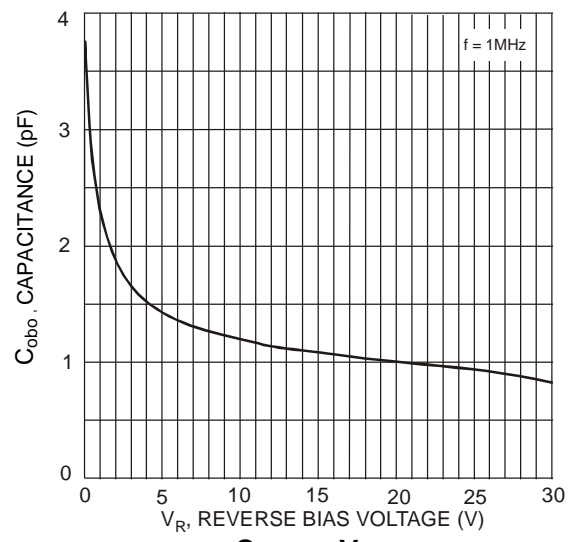

**$C_{obo}$  v  $V_R$**

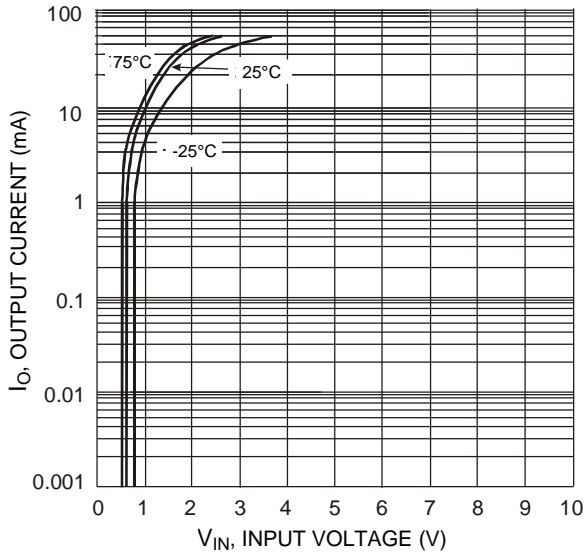

**$I_O$  v  $V_{IN}$**

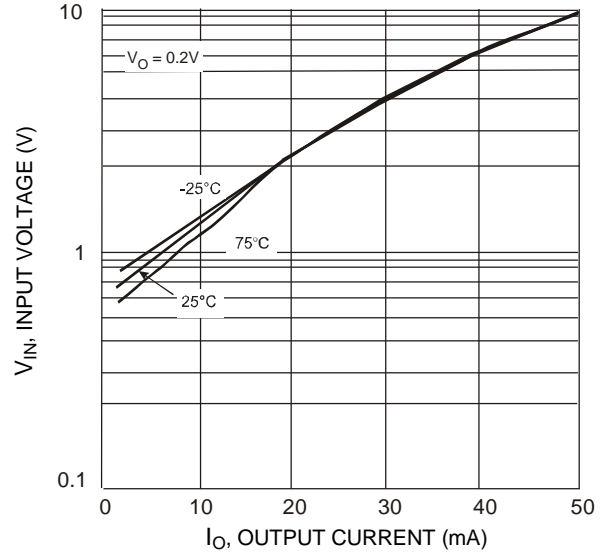

**$V_{IN}$  v  $I_O$**

**Typical Curves – DDC124EU** (@  $T_A = +25^\circ\text{C}$ , unless otherwise specified.)

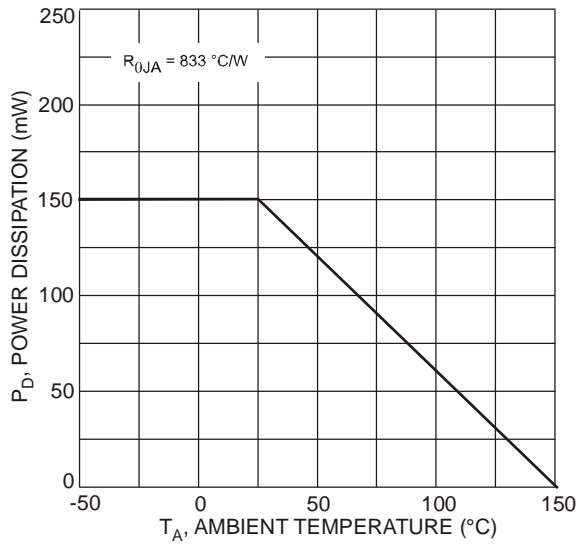

**$P_D$  v  $T_A$**

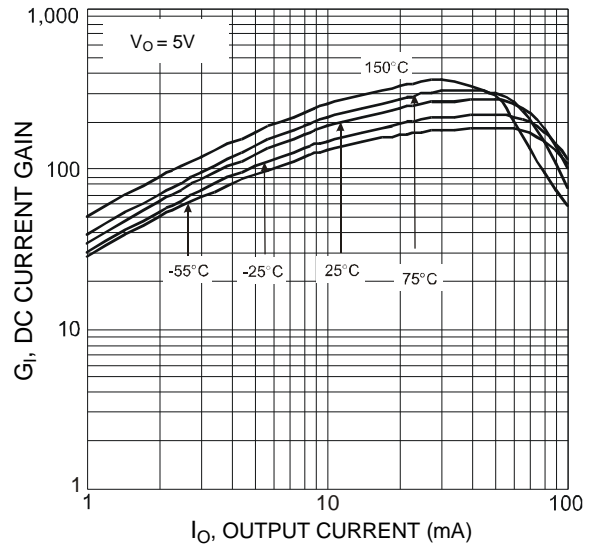

**$G_I$  v  $I_O$**

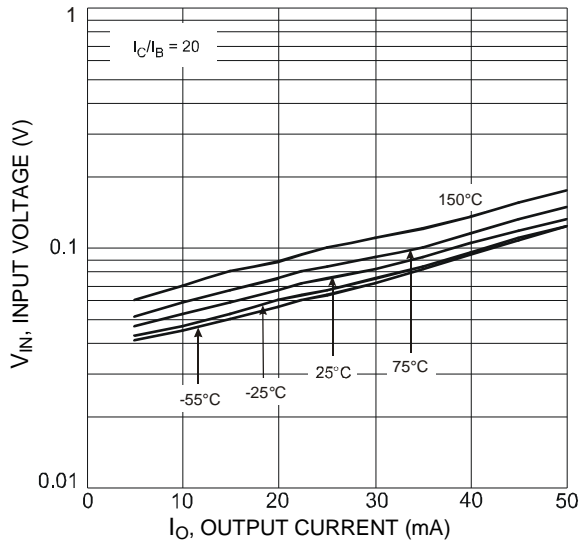

**$V_{IN}$  v  $I_O$**

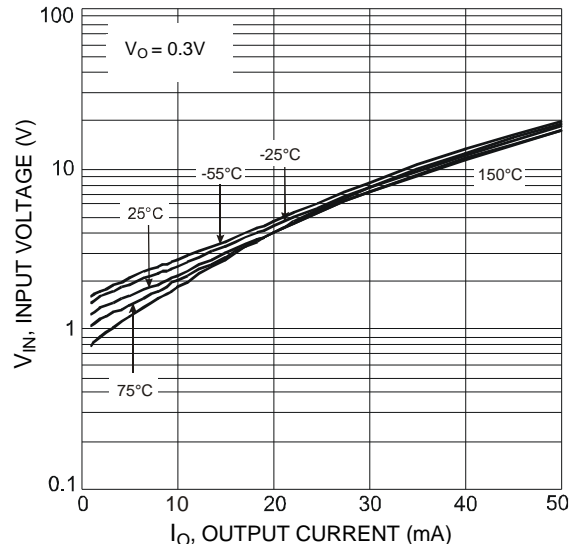

**$V_{IN}$  v  $I_O$**

**Package Outline Dimensions**

Please see <http://www.diodes.com/package-outlines.html> for the latest version.

SOT363

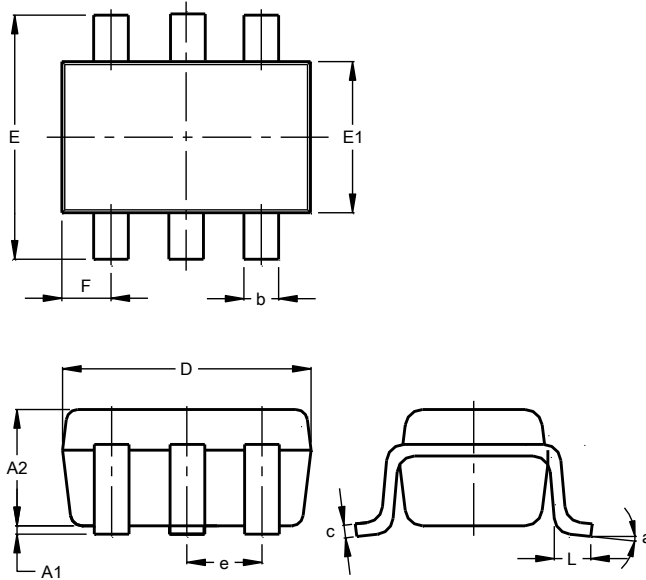

SOT363			
Dim	Min	Max	Typ
A1	0.00	0.10	0.05
A2	0.90	1.00	0.95
b	0.10	0.30	0.25
c	0.10	0.22	0.11
D	1.80	2.20	2.15
E	2.00	2.20	2.10
E1	1.15	1.35	1.30
e	0.650 BSC		
F	0.40	0.45	0.425
L	0.25	0.40	0.30
a	0°	8°	--
<b>All Dimensions in mm</b>			

**Suggested Pad Layout**

Please see <http://www.diodes.com/package-outlines.html> for the latest version.

SOT363

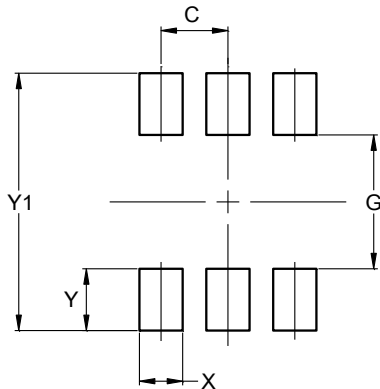

Dimensions	Value (in mm)
C	0.650
G	1.300
X	0.420
Y	0.600
Y1	2.500

**IMPORTANT NOTICE**

1. DIODES INCORPORATED (Diodes) AND ITS SUBSIDIARIES MAKE NO WARRANTY OF ANY KIND, EXPRESS OR IMPLIED, WITH REGARDS TO ANY INFORMATION CONTAINED IN THIS DOCUMENT, INCLUDING, BUT NOT LIMITED TO, THE IMPLIED WARRANTIES OF MERCHANTABILITY, FITNESS FOR A PARTICULAR PURPOSE OR NON-INFRINGEMENT OF THIRD PARTY INTELLECTUAL PROPERTY RIGHTS (AND THEIR EQUIVALENTS UNDER THE LAWS OF ANY JURISDICTION).
2. The Information contained herein is for informational purpose only and is provided only to illustrate the operation of Diodes' products described herein and application examples. Diodes does not assume any liability arising out of the application or use of this document or any product described herein. This document is intended for skilled and technically trained engineering customers and users who design with Diodes' products. Diodes' products may be used to facilitate safety-related applications; however, in all instances customers and users are responsible for (a) selecting the appropriate Diodes products for their applications, (b) evaluating the suitability of Diodes' products for their intended applications, (c) ensuring their applications, which incorporate Diodes' products, comply the applicable legal and regulatory requirements as well as safety and functional-safety related standards, and (d) ensuring they design with appropriate safeguards (including testing, validation, quality control techniques, redundancy, malfunction prevention, and appropriate treatment for aging degradation) to minimize the risks associated with their applications.
3. Diodes assumes no liability for any application-related information, support, assistance or feedback that may be provided by Diodes from time to time. Any customer or user of this document or products described herein will assume all risks and liabilities associated with such use, and will hold Diodes and all companies whose products are represented herein or on Diodes' websites, harmless against all damages and liabilities.
4. Products described herein may be covered by one or more United States, international or foreign patents and pending patent applications. Product names and markings noted herein may also be covered by one or more United States, international or foreign trademarks and trademark applications. Diodes does not convey any license under any of its intellectual property rights or the rights of any third parties (including third parties whose products and services may be described in this document or on Diodes' website) under this document.
5. Diodes' products are provided subject to Diodes' Standard Terms and Conditions of Sale (<https://www.diodes.com/about/company/terms-and-conditions/terms-and-conditions-of-sales/>) or other applicable terms. This document does not alter or expand the applicable warranties provided by Diodes. Diodes does not warrant or accept any liability whatsoever in respect of any products purchased through unauthorized sales channel.
6. Diodes' products and technology may not be used for or incorporated into any products or systems whose manufacture, use or sale is prohibited under any applicable laws and regulations. Should customers or users use Diodes' products in contravention of any applicable laws or regulations, or for any unintended or unauthorized application, customers and users will (a) be solely responsible for any damages, losses or penalties arising in connection therewith or as a result thereof, and (b) indemnify and hold Diodes and its representatives and agents harmless against any and all claims, damages, expenses, and attorney fees arising out of, directly or indirectly, any claim relating to any noncompliance with the applicable laws and regulations, as well as any unintended or unauthorized application.
7. While efforts have been made to ensure the information contained in this document is accurate, complete and current, it may contain technical inaccuracies, omissions and typographical errors. Diodes does not warrant that information contained in this document is error-free and Diodes is under no obligation to update or otherwise correct this information. Notwithstanding the foregoing, Diodes reserves the right to make modifications, enhancements, improvements, corrections or other changes without further notice to this document and any product described herein. This document is written in English but may be translated into multiple languages for reference. Only the English version of this document is the final and determinative format released by Diodes.
8. Any unauthorized copying, modification, distribution, transmission, display or other use of this document (or any portion hereof) is prohibited. Diodes assumes no responsibility for any losses incurred by the customers or users or any third parties arising from any such unauthorized use.
9. This Notice may be periodically updated with the most recent version available at <https://www.diodes.com/about/company/terms-and-conditions/important-notice>

DIODES is a trademark of Diodes Incorporated in the United States and other countries.  
The Diodes logo is a registered trademark of Diodes Incorporated in the United States and other countries.  
© 2022 Diodes Incorporated. All Rights Reserved.

[www.diodes.com](http://www.diodes.com)