



# FFH60UP60S, FFH60UP60S3

## Features

- High Speed Switching,  $t_{rr} < 80\text{ns}$
- High Reverse Voltage and High Reliability
- Avalanche Energy Rated
- Low Forward Voltage,  $V_F < 1.7\text{V}$
- RoHS compliant

## Applications

- General Purpose
- Switching Mode Power Supply
- Free-wheeling diode for motor application
- Power switching circuits

## 60A, 600V Ultrafast Rectifier

The FFH60UP60S and FFH60UP60S3 are ultrafast rectifiers with low forward voltage drop. It is a silicon nitride passivated ion-implanted epitaxial planar construction.

These devices are intended for use as freewheeling/clamping rectifiers in a variety of switching power supplies and other power switching applications. Its low stored charge minimize ringing and electrical noise in many power switching circuits reducing power loss in the switching transistors.

## Pin Assignments

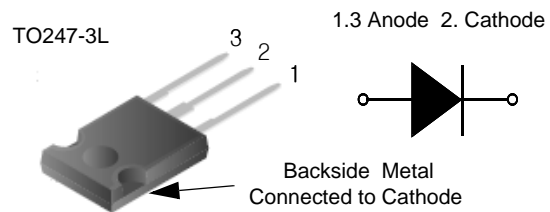
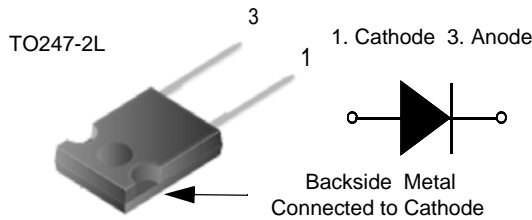

## Absolute Maximum Ratings $T_C = 25^\circ\text{C}$ unless otherwise noted

Symbol	Parameter	Ratings	Units
$V_{RRM}$	Peak Repetitive Reverse Voltage	600	V
$V_{RWM}$	Working Peak Reverse Voltage	600	V
$V_R$	DC Blocking Voltage	600	V
$I_{F(AV)}$	Average Rectified Forward Current @ $T_C = 93^\circ\text{C}$	60	A
$I_{FSM}$	Non-repetitive Peak Surge Current 60Hz Single Half-Sine Wave	600	A
$T_J, T_{STG}$	Operating and Storage Temperature Range	-65 to +150	$^\circ\text{C}$

## Thermal Characteristics

Symbol	Parameter	Ratings	Units
$R_{\theta JC}$	Maximum Thermal Resistance, Junction to Case	0.7	$^\circ\text{C/W}$

## Package Marking and Ordering Information

Device Marking	Device	Package	Reel Size	Tape Width	Quantity
FFH60UP60S	FFH60UP60S	TO247-2L	-	-	30
FFH60UP60S3	FFH60UP60S3	TO247-3L	-	-	30

### Electrical Characteristics $T_C = 25^\circ\text{C}$ unless otherwise noted

Symbol	Parameter	Min.	Typ.	Max.	Units
$V_{FM1}$	$I_F = 60\text{A}$	-	1.4	1.7	V
$I_{RM1}$	$V_R = 600\text{V}$	-	-	100	$\mu\text{A}$
$t_{rr}$	$I_F = 60\text{A}, di/dt = 200\text{A}/\mu\text{s}, V_{CC} = 390\text{V}$	-	60	80	ns
$W_{AVL}$	Avalanche Energy ( $L = 40\text{mH}$ )	50	-	-	mJ

**Notes:**

1: Pulse: Test Pulse width = 300 $\mu\text{s}$ , Duty Cycle = 2%

### Trr test circuit and waveform

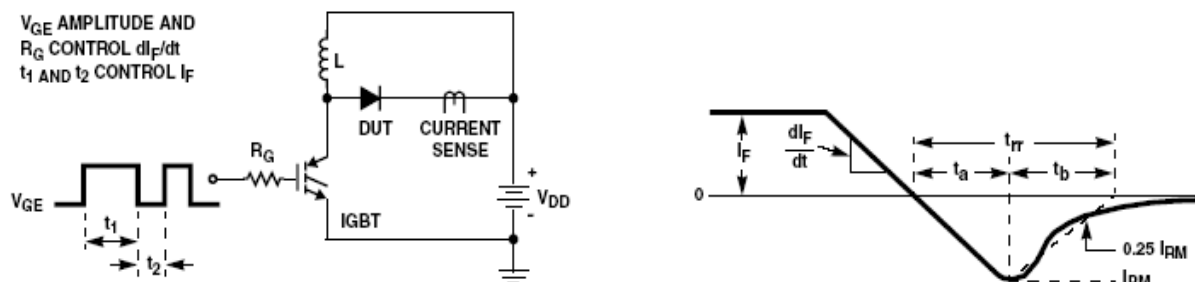

### Avalanch energy test circuit and waveform

$L = 40\text{mH}$   
 $R < 0.1\Omega$   
 $V_{DD} = 50\text{V}$

$E_{AVL} = 1/2 L I^2 [V_{R(AVL)} / (V_{R(AVL)} - V_{DD})]$   
 $Q1 = \text{IGBT (} BV_{CES} > \text{DUT } V_{R(AVL)} \text{)}$

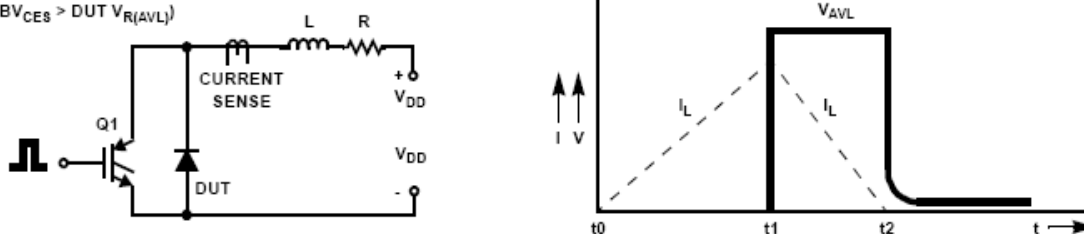

### Typical Performance Characteristics

Figure 1. Typical Forward Voltage Drop vs. Forward Current

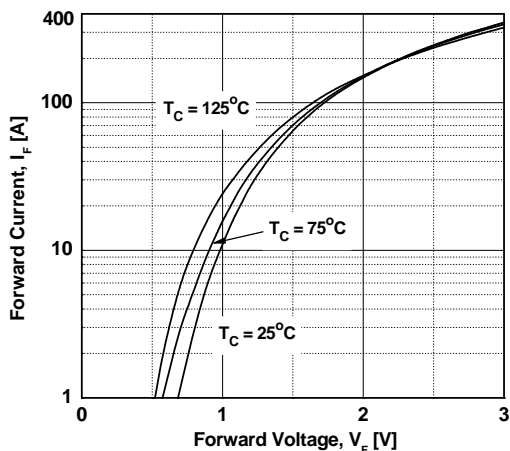

Figure 3. Typical Junction Capacitance

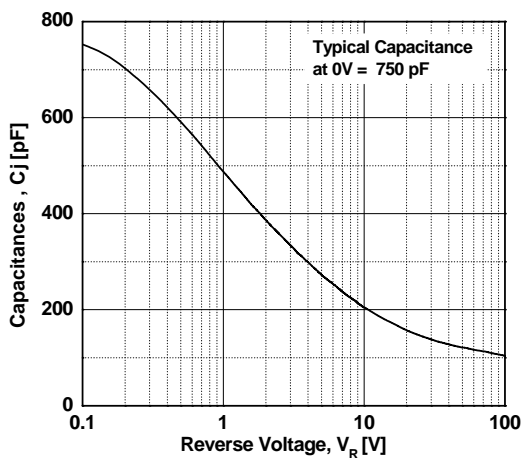

Figure 5. Typical Reverse Recovery Current vs. di/dt

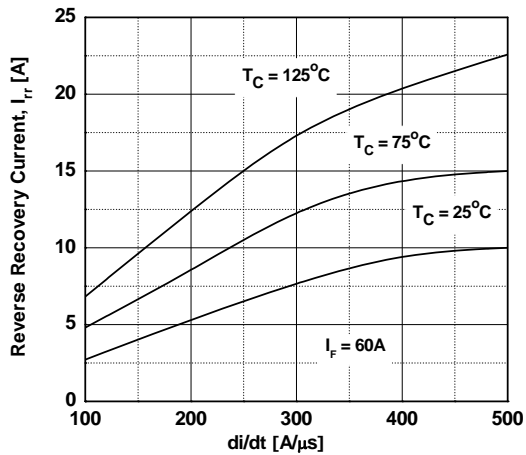

Figure 2. Typical Reverse Current vs. Reverse Voltage

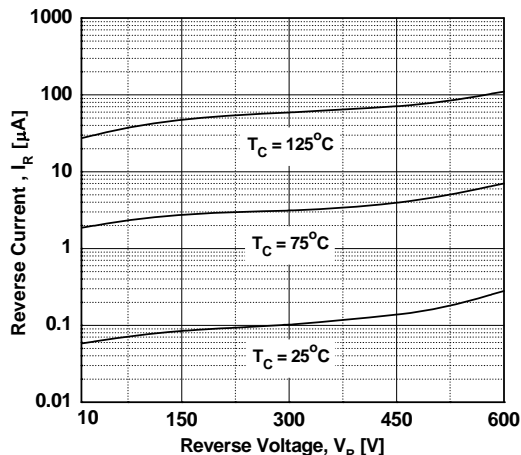

Figure 4. Typical Reverse Recovery Time vs. di/dt

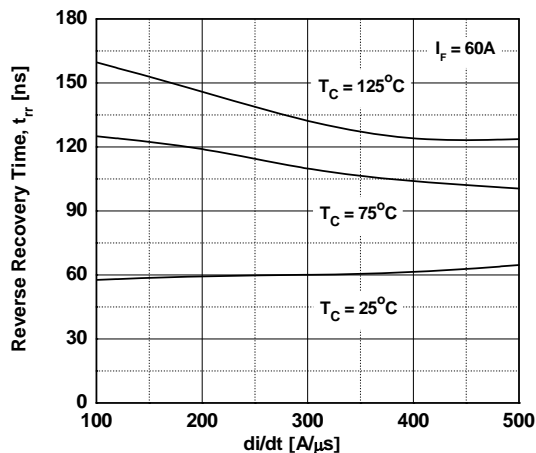
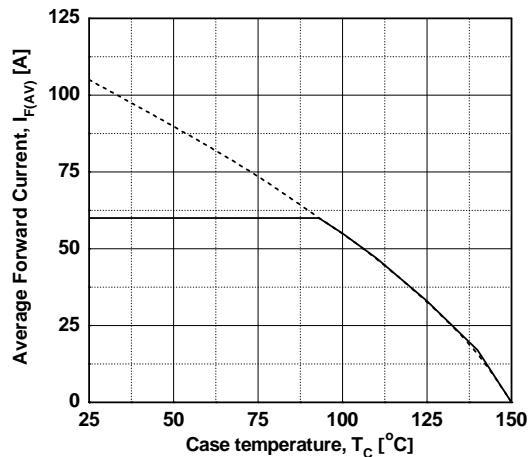
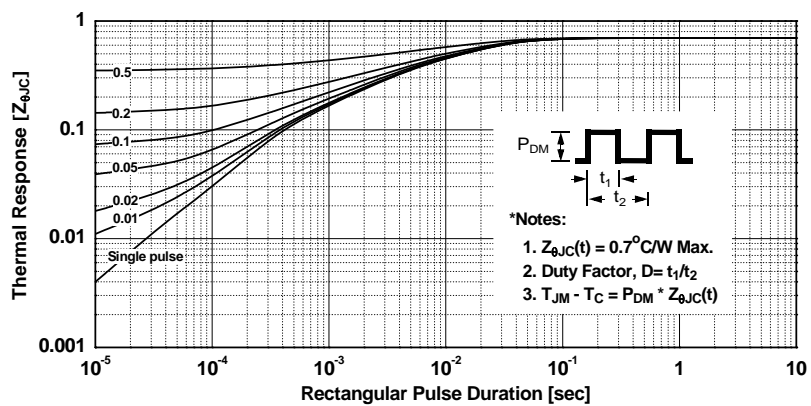

Figure 6. Forward Current Derating Curve



Typical Performance Characteristics (Continued)

Figure 14. Transient Thermal Response Curve



Mechanical Dimensions

TO247-2L

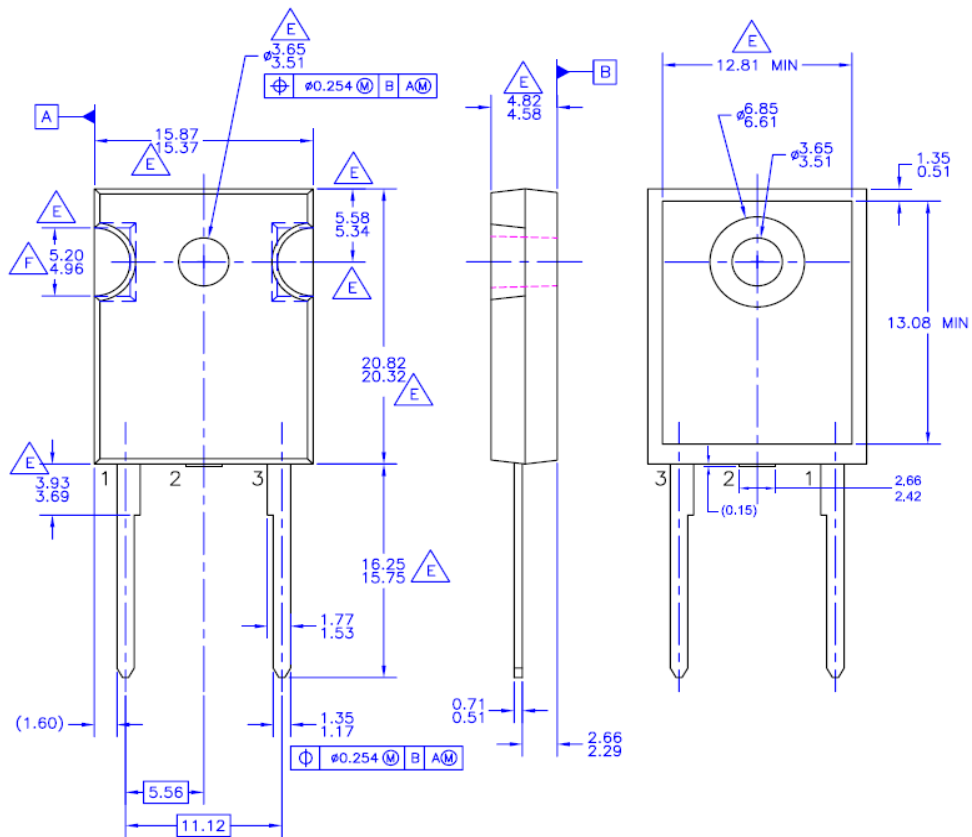

Dimensions in Millimeters

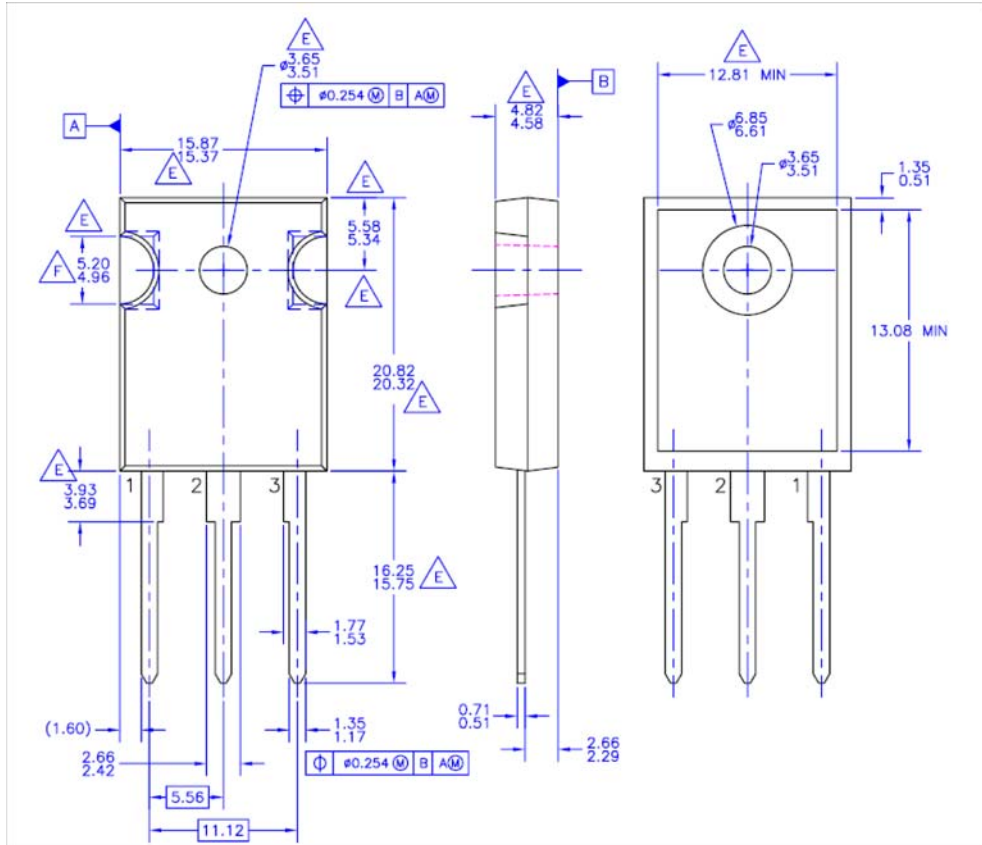

# TO247-3L





**TRADEMARKS**

The following includes registered and unregistered trademarks and service marks, owned by Fairchild Semiconductor and/or its global subsidiaries, and is not intended to be an exhaustive list of all such trademarks.

- |   |                                     |                                       |   |
|---|-------------------------------------|---------------------------------------|---|
| 2Cool™  | FlashWriter® *                      | PDP SPM™                              | The Power Franchise®  |
| AccuPower™  | FPS™                                | Power-SPM™                            | The Right Technology for Your Success™  |
| Auto-SPM™   | F-PFS™                              | PowerTrench®                          | the   |
| AX-CAP™*  | FRFET®                              | PowerXS™                              | <b>power</b>  |
| BitSiC®   | Global Power Resource <sup>SM</sup> | Programmable Active Droop™            | franchise   |
| Build it Now™   | Green FPS™                          | QFET®                                 | TinyBoost™  |
| CorePLUS™   | Green FPST™ e-Series™               | QST™                                  | TinyBuck™   |
| CorePOWER™  | Gmax™                               | Quiet Series™                         | TinyCalc™   |
| CROSSVOLT™  | GTO™                                | RapidConfigure™                       | TinyLogic®  |
| CTL™  | IntelliMAX™                         |                                       | TINYOPTO™   |
| Current Transfer Logic™   | ISOPLANAR™                          | Saving our world, 1mW/W/kW at a time™ | TinyPower™  |
| DEUXPEED®   | MegaBuck™                           | SignalWise™                           | TinyPWM™  |
| Dual Cool™  | MICROCOUPLER™                       | SmartMax™                             | TinyWire™   |
| EcoSPARK®   | MicroFET™                           | SMART START™                          | TranSiC®  |
| EfficientMax™   | MicroPak™                           | SPM®                                  | TriFault Detect™  |
| ESBC™   | MicroPak2™                          | STEALTH™                              | TRUECURRENT®*   |
|  | MillerDrive™                        | SuperFET®                             | µSerDes™  |
| Fairchild®  | MotionMax™                          | SuperSOT™-3                           |  |
| Fairchild Semiconductor®  | Motion-SPM™                         | SuperSOT™-6                           | UHC®  |
| FACT Quiet Series™  | mWSaver™                            | SuperSOT™-8                           | Ultra FRFET™  |
| FACT®   | OptiHiT™                            | SupreMOS®                             | UniFET™   |
| FAST®   | OPTOLOGIC®                          | SyncFET™                              | VCX™  |
| FastvCore™  | OPTOPLANAR®                         | Sync-Lock™                            | VisualMax™  |
| FETBench™   |                                     |                                       | XS™   |

\*Trademarks of System General Corporation, used under license by Fairchild Semiconductor.

**DISCLAIMER**

FAIRCHILD SEMICONDUCTOR RESERVES THE RIGHT TO MAKE CHANGES WITHOUT FURTHER NOTICE TO ANY PRODUCTS HEREIN TO IMPROVE RELIABILITY, FUNCTION, OR DESIGN. FAIRCHILD DOES NOT ASSUME ANY LIABILITY ARISING OUT OF THE APPLICATION OR USE OF ANY PRODUCT OR CIRCUIT DESCRIBED HEREIN; NEITHER DOES IT CONVEY ANY LICENSE UNDER ITS PATENT RIGHTS, NOR THE RIGHTS OF OTHERS. THESE SPECIFICATIONS DO NOT EXPAND THE TERMS OF FAIRCHILD'S WORLDWIDE TERMS AND CONDITIONS, SPECIFICALLY THE WARRANTY THEREIN, WHICH COVERS THESE PRODUCTS.

**LIFE SUPPORT POLICY**

FAIRCHILD'S PRODUCTS ARE NOT AUTHORIZED FOR USE AS CRITICAL COMPONENTS IN LIFE SUPPORT DEVICES OR SYSTEMS WITHOUT THE EXPRESS WRITTEN APPROVAL OF FAIRCHILD SEMICONDUCTOR CORPORATION.

As used here in:

- Life support devices or systems are devices or systems which, (a) are intended for surgical implant into the body or (b) support or sustain life, and (c) whose failure to perform when properly used in accordance with instructions for use provided in the labeling, can be reasonably expected to result in a significant injury of the user.
- A critical component in any component of a life support, device, or system whose failure to perform can be reasonably expected to cause the failure of the life support device or system, or to affect its safety or effectiveness.

**ANTI-COUNTERFEITING POLICY**

Fairchild Semiconductor Corporation's Anti-Counterfeiting Policy. Fairchild's Anti-Counterfeiting Policy is also stated on our external website, www.Fairchildsemi.com, under Sales Support.

Counterfeiting of semiconductor parts is a growing problem in the industry. All manufactures of semiconductor products are experiencing counterfeiting of their parts. Customers who inadvertently purchase counterfeit parts experience many problems such as loss of brand reputation, substandard performance, failed application, and increased cost of production and manufacturing delays. Fairchild is taking strong measures to protect ourselves and our customers from the proliferation of counterfeit parts. Fairchild strongly encourages customers to purchase Fairchild parts either directly from Fairchild or from Authorized Fairchild Distributors who are listed by country on our web page cited above. Products customers buy either from Fairchild directly or from Authorized Fairchild Distributors are genuine parts, have full traceability, meet Fairchild's quality standards for handling and storage and provide access to Fairchild's full range of up-to-date technical and product information. Fairchild and our Authorized Distributors will stand behind all warranties and will appropriately address and warranty issues that may arise. Fairchild will not provide any warranty coverage or other assistance for parts bought from Unauthorized Sources. Fairchild is committed to combat this global problem and encourage our customers to do their part in stopping this practice by buying direct or from authorized distributors.

**PRODUCT STATUS DEFINITIONS**

**Definition of Terms**

Datasheet Identification	Product Status	Definition
Advance Information	Formative / In Design	Datasheet contains the design specifications for product development. Specifications may change in any manner without notice.
Preliminary	First Production	Datasheet contains preliminary data; supplementary data will be published at a later date. Fairchild Semiconductor reserves the right to make changes at any time without notice to improve design.
No Identification Needed	Full Production	Datasheet contains final specifications. Fairchild Semiconductor reserves the right to make changes at any time without notice to improve the design.
Obsolete	Not In Production	Datasheet contains specifications on a product that is discontinued by Fairchild Semiconductor. The datasheet is for reference information only.