

KEMET Part Number: C1206C224K1RACTU
(C1206C224K1RAC7800)

SMD Comm X7R, Ceramic, 0.22 uF, 10%, 100 VDC, X7R, SMD, MLCC, Temperature Stable, Class II, 1206

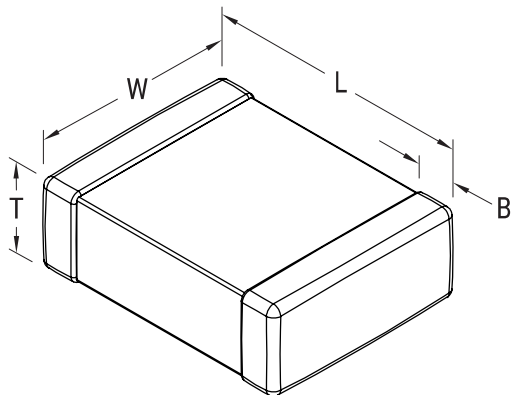

Dimensions

L	3.2mm +/-0.2mm
W	1.6mm +/-0.2mm
T	0.9mm +/-0.10mm
B	0.5mm +/-0.25mm

Packaging Specifications

Packaging:	T&R, 180mm, Plastic Tape
Packaging Quantity:	4000

General Information

Supplier:	KEMET
Series:	SMD Comm X7R
Style:	SMD Chip
Description:	SMD, MLCC, Temperature Stable, Class II
Features:	Temperature Stable, Class II
RoHS:	Yes
Termination:	Tin
Marking:	No
Miscellaneous:	Note: Referee time for X7R dielectric for this part number is 1000 hours
Chip Size:	1206
Shelf Life:	78 Weeks
MSL:	1

Specifications

Capacitance:	0.22 uF
Capacitance Tolerance:	10%
Voltage DC:	100 VDC
Dielectric Withstanding Voltage:	250 VDC
Temperature Range:	-55/+125°C
Temperature Coefficient:	X7R
Dissipation Factor:	2.50% 1kHz 25C
Aging Rate:	3% Loss/Decade Hour
Insulation Resistance:	4.545 GOhms