



Handheld Reader V410-H

Versatile, powerful decode performance for any application.

- Simple configuration and management of multiple readers via WebLink^{PC}
- Point-and-shoot decode performance and minimal workflow disruption
- Industry-leading 1D/2D DPM decoding performance with Omron's X-Mode Imaging Technology (V410-H XD)
- IP52 sealing to protect against spills
- Captures 1D and 2D barcodes at variable distances and densities
- Covered speaker and screw holes to mitigate bacteria buildup (V410-H HC)
- On-the-fly switching between handheld and hands-free reading



Product Ordering Information

Part	Description	Part Number
	V410-H XD Handheld Reader, Black Grey, Wired, with X-Mode	V410-HDS4608XD
	V410-H SR Handheld Reader, Black Grey, Wired	V410-HDS4608SR
	V410-H HC Handheld Reader, White, Wired	V410-HDS4608HC

V410-H

Accessories

Appearance	Type	Part Number
	Presentation Stand, V410-H	V410-AS0
	Cable Assembly, Style 3 USB, 7 Ft, Mod Plug	V410-WUB-2M
	Cable Assembly, RS232, DB9F, TXD-2, 7 Ft, V410-H	V410-WR-2M
	Kit, V410-H AC Power Supply 5.2VDC, 1.1A	V410-AC0-1

Configurations

• USB

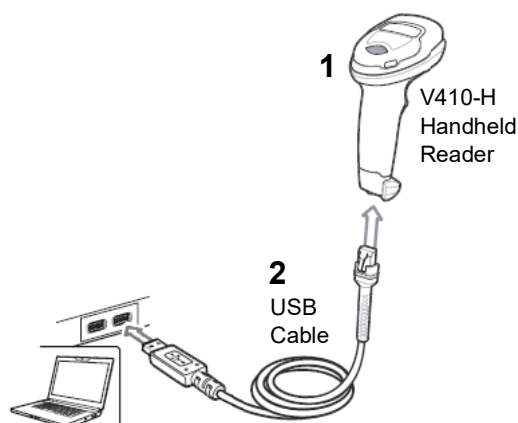

Part	Description	Part Number
1	V410-H XD Handheld Reader, Black Grey, Wired, with X-Mode	V410-HDS4608XD
	V410-H SR Handheld Reader, Black Grey, Wired	V410-HDS4608SR
	V410-H HC Handheld Reader, White, Wired	V410-HDS4608HC
2	Cable, USB, 7 ft., Mod Plug	V410-WUB-2M

• RS-232

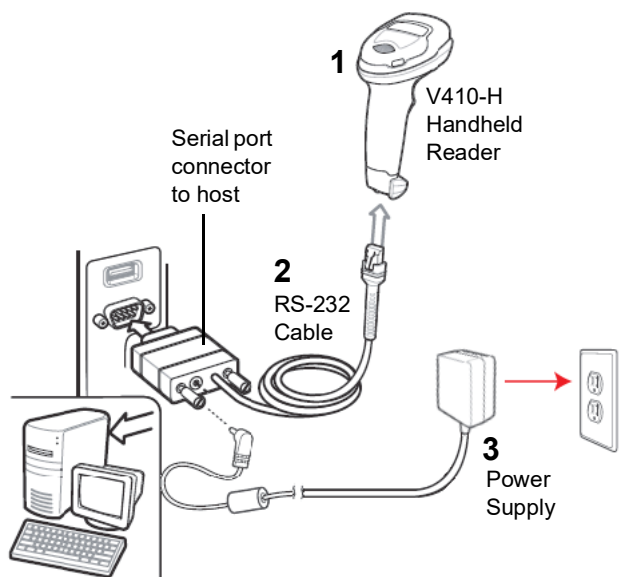

Part	Description	Part Number
1	V410-H XD Handheld Reader, Black Grey, Wired, with X-Mode	V410-HDS4608XD
	V410-H SR Handheld Reader, Black Grey, Wired	V410-HDS4608SR
	V410-H HC Handheld Reader, White, Wired	V410-HDS4608HC
2	Cable, RS-232, DB9F, TXD-2, 7 ft.	V410-WR-2M
3	Kit, V410-H AC Power Supply, 5.2 VDC, 1A	V410-AC0-1

V410-H

Ratings and Specifications

V410-H	XD	SR	HC
Item	Description		
Physical Characteristics			
Dimensions	6.5 in. H x 2.6 in. W x 3.9 in. D 165 mm H x 67 mm W x 98 mm D		
Weight	5.7 oz. / 161.9 g		
Input Voltage Range	4.5 to 5.5 VDC Host Powered; 4.5 to 5.5 VDC External Power Supply		
Operating Current at Nominal Voltage (5.0V)	375 mA (typical)	340 mA (typical)	375 mA (typical)
Standby Current (Idle) at Nominal Voltage (5.0V)	150 mA (typical)		
Color	Black Grey	Black Grey	Healthcare White
Supported Host Interfaces	USB 1.1, RS-232		
USB Certification	USB 1.1 Certified		
Keyboard Support	Supports over 90 international keyboards		
Electronic Article Surveillance		Compatible with Checkpoint EAS deactivation system	
User Indicators	Direct Decode Indicator, Good Decode LEDs, rear view LEDs, beeper (adjustable tone and volume), haptic/vibration	Direct Decode Indicator, Good Decode LEDs, rear view LEDs, beeper (adjustable tone and volume)	Direct Decode Indicator, Good Decode LEDs, rear view LEDs, beeper (adjustable tone and volume), haptic/vibration
Performance Characteristics			
Light Source	Aiming Pattern: circular 528nm true green LED	Aiming Pattern: circular 617nm amber LED	Aiming Pattern: circular 528nm true green LED
Illumination	(2) Warm White LEDs	(2) 660nm Red LEDs	(2) Warm White LEDs
Imager Field of View	34° H x 21.6° V nominal	36.1° H x 22.6° V nominal	35° H x 22° V nominal
Image Sensor	1280 x 800 pixels		
Minimum Print Contrast	15% minimum reflective difference		
Skew Tolerance	+/- 60°		
Pitch Tolerance	+/- 60°		
Roll Tolerance	0° - 360°		
Imaging Characteristics			
Graphics Format Support	Images can be exported as Bitmap, JPEG, or TIFF		
Image Quality	96 PPI on an A4 document		
Environmental			
Operating Temperature	32.0° to 122.0° F / 0.0° to 50.0° C		
Storage Temperature	-40.0° to 158.0° F / -40.0° to 70.0° C		
Humidity	5% to 95% RH, non-condensing		
Drop Specification	Designed to withstand multiple drops at 6.0 ft./1.8 m to concrete		
Tumble Specification	Designed to withstand 2,000 tumbles in 1.5 ft./0.5 m tumbler		
Environmental Sealing	IP52		
Approved Cleaners	Standard disinfectants		
Electrostatic Discharge (ESD)	ESD per EN61000-4-2, +/-15 KV Air, +/-8 KV Direct, +/-8 KV Indirect		
Ambient Light Immunity	0 to 10,000 foot-candles / 0 to 107,600 lux		
Accessories	Gooseneck Intellistand		
Symbol Decode Capability			
1D	Code 39, Code 128, Code 93, Codabar/NW7, Code 11, MSI Plessey, UPC/EAN, I 2 of 5, Korean 3 of 5, GS1 DataBar, Base 32 (Italian Pharma)		
2D	PDF417, Micro PDF417, Composite Codes, TLC-39, Aztec, Data Matrix, QR Code, Micro QR, Han Xin, Postal Codes, SecurPharm, DotCode, Dotted Data Matrix	PDF417, Micro PDF417, Composite Codes, TLC-39, Aztec, Data Matrix, QR Code, Micro QR, Han Xin, Postal Codes, SecurPharm, DotCode, Dotted Data Matrix	PDF417, Micro PDF417, Composite Codes, TLC-39, Aztec, Data Matrix, QR Code, Micro QR, Han Xin, Postal Codes, SecurPharm
OCR	OCR-A, OCR-B, MICR, US Currency		
Minimum Element Resolution	Code 39 - 2.0 mil Data Matrix - 4.0 mil	Code 39 - 3.0 mil Data Matrix - 5.0 mil	Code 39 - 2.0 mil Data Matrix - 4.0 mil
Decode Ranges (Typical; Printing resolution, contrast, and ambient light-dependent)			
Symbology/Resolution	Near/Far	Near/Far	Near/Far
Code 128: 2 mil	0.3 in. / 8 mm to 2.3 in. / 58 mm		
Code 128: 3 mil	0 in. / 0 mm to 3.5 in. / 88 mm		
Code 128: 5 mil		2.7 in. / 69 mm to 5.4 in. / 137 mm	1.7 in. / 43 mm to 5.0 in. / 127 mm
Code 128: 15 mil	4.2 in. / 107 mm to 8.6 in. / 218 mm		
Code 39: 2 mil	0.2 in. / 5 mm to 3.0 in. / 76 mm		
Code 39: 3 mil	0 in. / 0 mm to 3.8 in. / 96 mm	2.2 in. / 56 mm to 5.4 in. / 137 mm	1.3 in. / 33 mm to 6.0 in. / 152 mm
Code 39: 5 mil	0 in. / 0 mm to 5.2 in. / 132 mm	0.7 in. / 18 mm to 11.0 in. / 279 mm	0.1 in. / 3 mm to 11.5 in. / 292 mm
Code 39: 20 mil		0 in. / 0 mm to 44.0 in. / 1118 mm	0.6 in. / 15 mm to 29.0 in. / 737 mm

V410-H	XD	SR	HC
Item	Description		
PDF417: 4 mil	0 in. / 0 mm to 3.3 in. / 84 mm		
PDF417: 5 mil	0 in. / 0 mm to 3.8 in. / 96 mm		
PDF417: 6.6 mil	0 in. / 0 mm to 4.5 in. / 114 mm		
PDF417: 6.7 mil		1.3 in. / 33 mm to 10.0 in. / 254 mm	0.6 in. / 15 mm to 9.3 in. / 236 mm
UPC: 13 mil (100%)	0 in. / 0 mm to 8.5 in. / 215 mm	0 in. / 0 mm to 28.0 in. / 711 mm	0 in. / 0 mm to 18.0 in. / 457 mm
Data Matrix: 4 mil	0.2 in. / 5 mm to 2.8 in. / 71 mm		
Data Matrix: 5 mil	0 in. / 0 mm to 3.4 in. / 86 mm		
Data Matrix: 10 mil	0 in. / 0 mm to 4.8 in. / 122 mm	1.0 in. / 25 mm to 11.5 in. / 292 mm	0.2 in. / 5 mm to 9.5 in. / 241 mm
QR Code: 10 mil	0 in. / 0 mm to 4.5 in. / 114 mm		
QR Code: 20 mil		0 in. / 0 mm to 17.5 in. / 445 mm	0 in. / 0 mm to 13.5 in. / 343 mm
Utilities and Device Management			
WebLink ^{PC}	Programs reader parameters, upgrades firmware, provides encoded barcode data, allows image-based troubleshooting		
Regulatory Compliance			
LED Safety Standard	IEC 62471 Exempt Risk Group		
EMC Standards	EN 55032, EN 55035, FCC Part 15, Subpart B (Class B)		
Safety Standards	EN 62368-1		
Certifications	RCM, EAC, BSMI, CE, cULus (KC under application)		

Imager Field of View

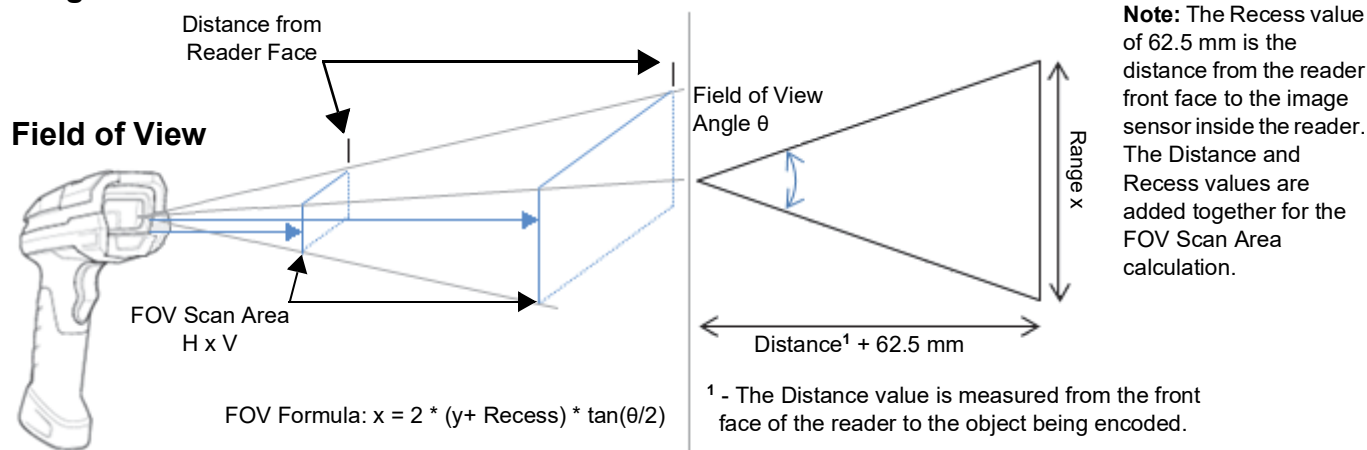

XD: Image Field of View in degrees = 34 (horizontal) x 21.6 (vertical)

y (mm)	y + Recess	θ	Range x (mm)	FOV Scan Area H x V (mm)	Distance from Reader Face (mm)	FOV Scan Area H x V (in)	Distance from Reader Face (in)
5	67.5	34	41	41 x 26	5	1.6 x 1.0	0.2
5	67.5	21.6	26	-	-	-	-
71	133.5	34	82	82 x 51	71	3.2 x 2.0	2.8
71	133.5	21.6	51	-	-	-	-

SR: Image Field of View in degrees = 36.1 (horizontal) x 22.6 (vertical)

y (mm)	y + Recess	θ	Range x (mm)	FOV Scan Area H x V (mm)	Distance from Reader Face (mm)	FOV Scan Area H x V (in)	Distance from Reader Face (in)
25	87.5	36.1	57	57 x 35	25	2.2 x 1.4	1.0
25	87.5	22.6	35	-	-	-	-
445	507.5	36.1	331	331 x 203	445	13.0 x 8.0	17.5
445	507.5	22.6	203	-	-	-	-

HC: Image Field of View in degrees = 35 (horizontal) x 22 (vertical)

y (mm)	y + Recess	θ	Range x (mm)	FOV Scan Area H x V (mm)	Distance from Reader Face (mm)	FOV Scan Area H x V (in)	Distance from Reader Face (in)
3	65.5	35	41	41 x 25	3	1.6 x 1.0	0.1
3	65.5	22	25	-	-	-	-
292	354.5	25	223	223 x 138	292	8.8 x 5.4	11.5
292	354.5	22	138	-	-	-	-

V410-H

Dimensions

(Unit: mm / [in])

V410-H Handheld Reader

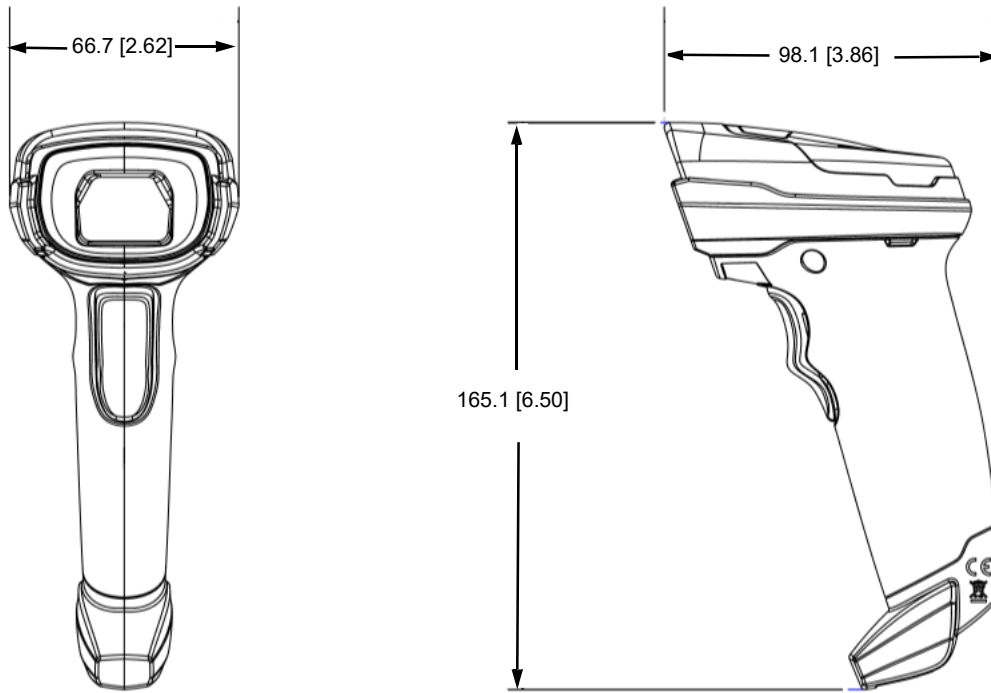

Note: Reader dimensions are the same for the V410-H XD, V410-H SR, and V410-H HC.

WebLinkPC

Screenshot of WebLinkPC Setup screen where the user configures the handheld reader to meet application requirements. To download WebLinkPC, go to www.automation.omron.com/weblinkpc.

Related Manuals

Man. No.	Model	Manual
Z439 (84-9000362-02)	V410-HDS4608SR, V410-HDS4608XD, V410-HDS4608HC, V450-HDS3608-0001, V450-HDS3608-0002	V410-H and V450-H Handheld Barcode Reader User Manual

Terms and Conditions Agreement

Read and understand this catalog.

Please read and understand this catalog before purchasing the products. Please consult your OMRON representative if you have any questions or comments.

Warranties.

- (a) Exclusive Warranty. Omron's exclusive warranty is that the Products will be free from defects in materials and workmanship for a period of twelve months from the date of sale by Omron (or such other period expressed in writing by Omron). Omron disclaims all other warranties, express or implied.
- (b) Limitations. OMRON MAKES NO WARRANTY OR REPRESENTATION, EXPRESS OR IMPLIED, ABOUT NON-INFRINGEMENT, MERCHANTABILITY OR FITNESS FOR A PARTICULAR PURPOSE OF THE PRODUCTS. BUYER ACKNOWLEDGES THAT IT ALONE HAS DETERMINED THAT THE PRODUCTS WILL SUITABLY MEET THE REQUIREMENTS OF THEIR INTENDED USE.

Omron further disclaims all warranties and responsibility of any type for claims or expenses based on infringement by the Products or otherwise of any intellectual property right. (c) Buyer Remedy. Omron's sole obligation hereunder shall be, at Omron's election, to (i) replace (in the form originally shipped with Buyer responsible for labor charges for removal or replacement thereof) the non-complying Product, (ii) repair the non-complying Product, or (iii) repay or credit Buyer an amount equal to the purchase price of the non-complying Product; provided that in no event shall Omron be responsible for warranty, repair, indemnity or any other claims or expenses regarding the Products unless Omron's analysis confirms that the Products were properly handled, stored, installed and maintained and not subject to contamination, abuse, misuse or inappropriate modification. Return of any Products by Buyer must be approved in writing by Omron before shipment. Omron Companies shall not be liable for the suitability or unsuitability or the results from the use of Products in combination with any electrical or electronic components, circuits, system assemblies or any other materials or substances or environments. Any advice, recommendations or information given orally or in writing, are not to be construed as an amendment or addition to the above warranty.

See <http://www.omron.com/global/> or contact your Omron representative for published information.

Limitation on Liability; Etc.

OMRON COMPANIES SHALL NOT BE LIABLE FOR SPECIAL, INDIRECT, INCIDENTAL, OR CONSEQUENTIAL DAMAGES, LOSS OF PROFITS OR PRODUCTION OR COMMERCIAL LOSS IN ANY WAY CONNECTED WITH THE PRODUCTS, WHETHER SUCH CLAIM IS BASED IN CONTRACT, WARRANTY, NEGLIGENCE OR STRICT LIABILITY.

Further, in no event shall liability of Omron Companies exceed the individual price of the Product on which liability is asserted.

Suitability of Use.

Omron Companies shall not be responsible for conformity with any standards, codes or regulations which apply to the combination of the Product in the Buyer's application or use of the Product. At Buyer's request, Omron will provide applicable third party certification documents identifying ratings and limitations of use which apply to the Product. This information by itself is not sufficient for a complete determination of the suitability of the Product in combination with the end product, machine, system, or other application or use. Buyer shall be solely responsible for determining appropriateness of the particular Product with respect to Buyer's application, product or system. Buyer shall take application responsibility in all cases.

NEVER USE THE PRODUCT FOR AN APPLICATION INVOLVING SERIOUS RISK TO LIFE OR PROPERTY OR IN LARGE QUANTITIES WITHOUT ENSURING THAT THE SYSTEM AS A WHOLE HAS BEEN DESIGNED TO ADDRESS THE RISKS, AND THAT THE OMRON PRODUCT(S) IS PROPERLY RATED AND INSTALLED FOR THE INTENDED USE WITHIN THE OVERALL EQUIPMENT OR SYSTEM.

Programmable Products.

Omron Companies shall not be responsible for the user's programming of a programmable Product, or any consequence thereof.

Performance Data.

Data presented in Omron Company websites, catalogs and other materials is provided as a guide for the user in determining suitability and does not constitute a warranty. It may represent the result of Omron's test conditions, and the user must correlate it to actual application requirements. Actual performance is subject to the Omron's Warranty and Limitations of Liability.

Change in Specifications.

Product specifications and accessories may be changed at any time based on improvements and other reasons. It is our practice to change part numbers when published ratings or features are changed, or when significant construction changes are made. However, some specifications of the Product may be changed without any notice. When in doubt, special part numbers may be assigned to fix or establish key specifications for your application. Please consult with your Omron's representative at any time to confirm actual specifications of purchased Product.

Errors and Omissions.

Information presented by Omron Companies has been checked and is believed to be accurate; however, no responsibility is assumed for clerical, typographical or proofreading errors or omissions.

- QR code is the registered trademark of DENSO WAVE.
- Other company names and product names in this document are the trademarks or registered trademarks of their respective companies.
- The product photographs and figures that are used in this catalog may vary somewhat from the actual products.

Note: Do not use this document to operate the Unit.

OMRON Corporation Industrial Automation Company

Kyoto, JAPAN

Contact: www.ia.omron.com

Regional Headquarters

OMRON EUROPE B.V.
Wegalaan 67-69, 2132 JD Hoofddorp
The Netherlands
Tel: (31)2356-81-300/Fax: (31)2356-81-388

OMRON ELECTRONICS LLC
2895 Greenspoint Parkway, Suite 200
Hoffman Estates, IL 60169 U.S.A.
Tel: (1) 847-843-7900/Fax: (1) 847-843-7787

OMRON ASIA PACIFIC PTE. LTD.
No. 438A Alexandra Road # 05-05/08 (Lobby 2),
Alexandra Technopark,
Singapore 119967
Tel: (65) 6835-3011/Fax: (65) 6835-2711

OMRON (CHINA) CO., LTD.
Room 2211, Bank of China Tower,
200 Yin Cheng Zhong Road,
PuDong New Area, Shanghai, 200120, China
Tel: (86) 21-5037-2222/Fax: (86) 21-5037-2200

Authorized Distributor:

© OMRON Corporation 2020 All Rights Reserved. In the interest of product improvement, specifications are subject to change without notice.

Cat. No. Q292-E-01 (SP110C-EN-1020) 1020 (0620)