

Driver LC 25/30/35/40W 600/700/800/900mA fixC SC ADV advanced series

Product description

- Fixed output LED Driver
- Can be either used build-in or independent with clip-on strain-relief (see accessory)
- Independent LED Driver with cable clamps
- Constant current LED Driver
- For luminaires of protection class I and protection class II
- Temperature protection as per EN 61347-2-13 C5e
- Output current 600, 700, 800 or 900 mA
- Max. output power 26.5, 31, 35 or 40.5 W
- Nominal life-time up to 50,000 h
- 5-year guarantee

Housing properties

- Casing: polycarbonat, white
- Type of protection IP20

Functions

- Overtemperature protection
- Overload protection
- Short-circuit protection
- No-load protection
- Surge protection voltage 1 kV (L to N)
- Surge protection voltage 2 kV (L/N to earth)



Standards, page 3

Wiring diagrams and installation examples, page 4



With strain-relief

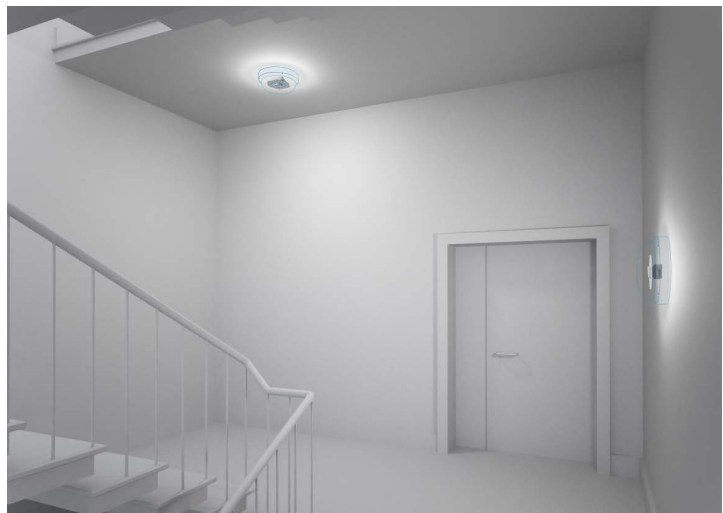

IP20 SELV 

Driver LC 25/30/35/40W 600/700/800/900mA fixC SC ADV

advanced series

Technical data

Rated supply voltage	220 – 240 V
AC voltage range	198 – 264 V
Mains frequency	50 / 60 Hz
Overvoltage protection	320 V AC, 1 h
THD (at 230 V, 50 Hz, full load)	< 20 %
Output current tolerance ^①	± 7.5 %
Typ. current ripple (at 230 V, 50 Hz, full load)	± 5 %
Max. output voltage	60 V
Starting time (at 230 V, 50 Hz, full load)	≤ 0.5 s
Turn off time (at 230 V, 50 Hz, full load)	≤ 0.2 s
Hold on time at power failure (output)	0 s
Ambient temperature ta	-20 ... +50 °C
Ambient temperature ta (at life-time 50,000 h)	40 °C
Storage temperature ts	-40 ... +80 °C
Life-time	up to 50,000 h
Dimensions L x W x H	97 x 43 x 30 mm
Dimensions with strain-relief L x W x H	157 x 43 x 30 mm

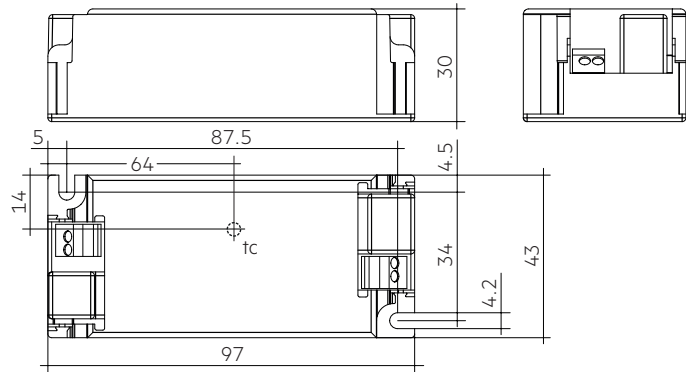

Ordering data

Type	Article number	Packaging, carton	Packaging, pallet	Weight per pc.
LC 25W 600mA fixC SC ADV	28002483	15 pc(s).	1,665 pc(s).	0.099 kg
LC 30W 700mA fixC SC ADV	28002484	15 pc(s).	1,665 pc(s).	0.101 kg
LC 35W 700mA fixC SC ADV	28002485	15 pc(s).	1,665 pc(s).	0.100 kg
LC 35W 800mA fixC SC ADV	28002486	15 pc(s).	1,665 pc(s).	0.101 kg
LC 40W 900mA fixC SC ADV	28002487	15 pc(s).	1,665 pc(s).	0.102 kg

Specific technical data

Type	Output current ^②	Input current (at 230 V, 50 Hz, full load)	Input power (at 230 V, 50 Hz, full load)	Output power range	λ at full load ^③	Efficiency at full load ^③	λ at min. load ^③	Efficiency at min. load ^③	Min. forward voltage	Max. forward voltage	Max. output peak current at full load ^②	Max. output peak current at min. load ^②	Max. casing temperature tc
LC 25W 600mA fixC SC ADV	600 mA	0.133 A	30.0 W	13.0 – 26.5 W	0.95	88 %	0.9C	81 %	21.4 V	44 V	774 mA	900 mA	80 °C
LC 30W 700mA fixC SC ADV	700 mA	0.153 A	34.3 W	15.0 – 31.0 W	0.95	88 %	0.9C	82 %	21.4 V	44 V	903 mA	1,000 mA	83 °C
LC 35W 700mA fixC SC ADV	700 mA	0.174 A	40.0 W	17.5 – 35.0 W	0.95	88 %	0.9C	82 %	25.0 V	50 V	903 mA	1,000 mA	75 °C
LC 35W 800mA fixC SC ADV	800 mA	0.181 A	40.0 W	20.0 – 36.0 W	0.95	89 %	0.9C	83 %	25.0 V	45 V	1,032 mA	1,100 mA	81 °C
LC 40W 900mA fixC SC ADV	900 mA	0.210 A	45.3 W	22.5 – 40.5 W	0.95	89 %	0.9C	83 %	25.0 V	45 V	1,161 mA	1,200 mA	83 °C

^① Test result at 230 V, 50 Hz.

^② The trend between min. and full load is linear.

^③ Output current is mean value.



Strain-relief set 43x30mm

Product description

- Optional strain-relief set for independent applications
- Transforms the LED Driver into a fully class II compatible LED Driver (e.g. ceiling installation)
- Easy and tool-free mounting to the LED Driver, screwless cable-clamp channels for long strain-relief (30 x 43 x 30 mm)
- With screws for short strain-relief (15 x 34 x 30 mm)
- Overall length = length L (LED Driver) + 2 x 30 mm (long strain-relief set), 2 x 15 mm (short strain-relief) or long and short strain-relief any combination
- Standard SC (L = 30 mm) available as non-pre-assembled and pre-assembled
- Short SC (L = 15 mm) only pre-assembled available



ACU SC 30x43x30mm CLIP-ON SR SET ACU SC 30x43x30mm CLIP-ON SR SET 300
(28001168, non-pre-assembled) (28001351, non-pre-assembled, 300 pcs. packaging)



ACU SC 30x43x30mm CLIP-ON SR PA
(28001699, pre-assembled)

ACU SC 15x43x30mm CLIP-ON SR PA
(28001574, pre-assembled)

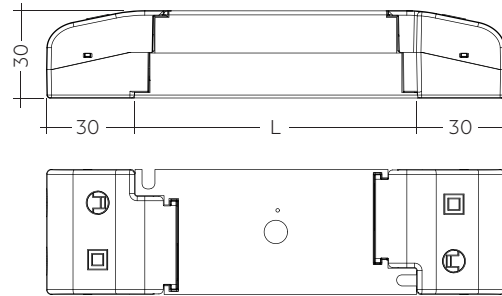

ACU SC 30x43x30mm CLIP-ON SR SET / PA

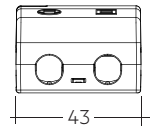

Permissible
cable jacket
diameter:
2.2 – 9 mm

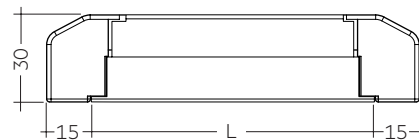

ACU SC 15x43x30mm CLIP-ON SR PA

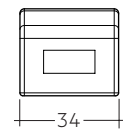

Permissible
cable jacket
diameter:
3 – 9 mm

Ordering data

Type	Article number	Packaging carton ^①	Packaging outer box	Weight per pc.
ACU SC 43x30mm CLIP-ON SR SET	28001168	10 pc(s).	500 pc(s).	0.038 kg
ACU SC 43x30mm CLIP-ON SR SET 300	28001351	300 pc(s).	300 pc(s).	0.038 kg
ACU SC 30x43x30mm CLIP-ON SR PA	28001699	10 pc(s).	500 pc(s).	0.021 kg
ACU SC 15x43x30mm CLIP-ON SR PA	28001574	10 pc(s).	1,200 pc(s).	0.010 kg

^① 28001168: A carton of 10 pcs. is equal to 10 sets, each with 2 strain-reliefs parts.

28001351: A carton of 300 pcs. is equal to 300 sets, each with 2 strain-reliefs parts.

28001699 + 28001574: A carton contains exactly 10 pcs. strain-reliefs (no sets).

1. Standards

EN 55015
EN 61000-3-2
EN 61000-3-3
EN 61347-1
EN 61347-2-13
EN 61547
EN 62384

1.1 Glow-wire test

according to EN 61347-1 with increased temperature of 850 °C passed.

2. Thermal details and life-time

2.1 Expected life-time

Expected life-time			
Type	ta	40 °C	50 °C
LC 25W 600mA fixC SC ADV	tc ^②	65 °C ^③	75 °C ^③
	Life-time	50,000 h	30,000 h
LC 30W 700mA fixC SC ADV	tc ^②	67 °C ^③	77 °C ^③
	Life-time	50,000 h	30,000 h
LC 35W 700mA fixC SC ADV	tc ^②	65 °C ^③	75 °C ^③
	Life-time	50,000 h	30,000 h
LC 35W 800mA fixC SC ADV	tc ^②	67 °C ^③	77 °C ^③
	Life-time	50,000 h	30,000 h
LC 40W 900mA fixC SC ADV	tc ^②	68 °C ^③	78 °C ^③
	Life-time	50,000 h	30,000 h

^① Test result at max. output voltage.

^② The tc temperature could be higher with different output voltages (refer to the tc vs. output voltage diagram for the details).

The LED Drivers are designed for a life-time stated above under reference conditions and with a failure probability of less than 10 %.

3. Installation / wiring

3.1 Circuit diagram

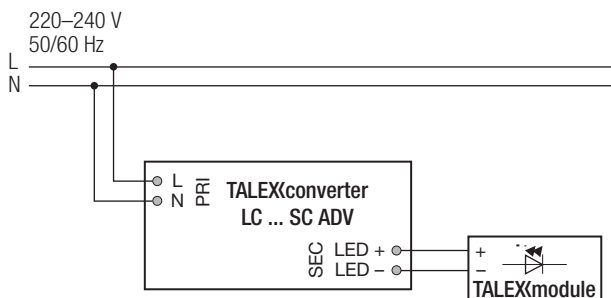

3.2 Wiring type and cross section

The wiring can be in stranded wires with ferrules or solid with a cross section of 0.5–1.5 mm². Strip 8.5–9.5 mm of insulation from the cables to ensure perfect operation of the push-wire terminals. Use one wire for each terminal connector only.

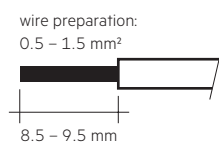

3.3 Release of the wiring

Press down the “push button” and remove the cable from front.

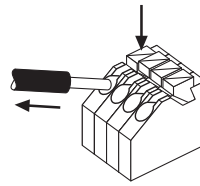

3.4 Fixing conditions when using as independent Driver with Clip-On

Dry, acidfree, oilfree, fatfree. It is not allowed to exceed the maximum ambient temperature (ta) stated on the device. Minimum distances stated below are recommendations and depend on the actual luminaire. Is not suitable for fixing in corner.

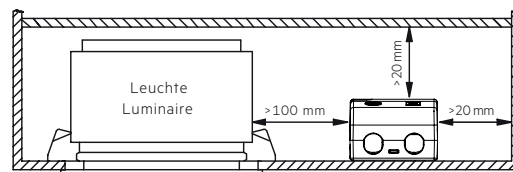

3.5 Wiring guidelines

- All connections must be kept as short as possible to ensure good EMI behaviour.
- Mains leads should be kept apart from LED Driver and other leads (ideally 5 – 10 cm distance)
- Max. length of output wires is 2 m.
- The secondary wires (LED module) should be routed in parallel to ensure good EMC performance.
- Secondary switching is not permitted.
- Incorrect wiring can damage LED modules.
- To avoid the damage of the Driver, the wiring must be protected against short circuits to earth (sharp edged metal parts, metal cable clips, louver, etc.).

3.6 Replace LED module

1. Mains off
2. Remove LED module
3. Wait for 10 seconds
4. Connect LED module again

Hot plug-in or secondary switching of LEDs is not permitted and may cause a very high current to the LEDs.

3.7 Installation instructions

The LED module and all contact points within the wiring must be sufficiently insulated against 1 kV surge voltage. Air and creepage distance must be maintained.

3.8 Mounting of device

Max. torque for fixing: 0.5 Nm/M4

4. Electrical values

4.1 Diagrams LC 25W 600mA fixC SC ADV

4.1.1 Efficiency vs load

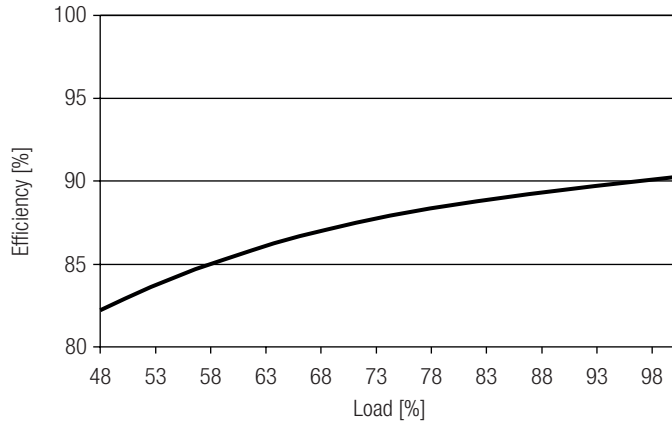

4.1.4 Input current vs load

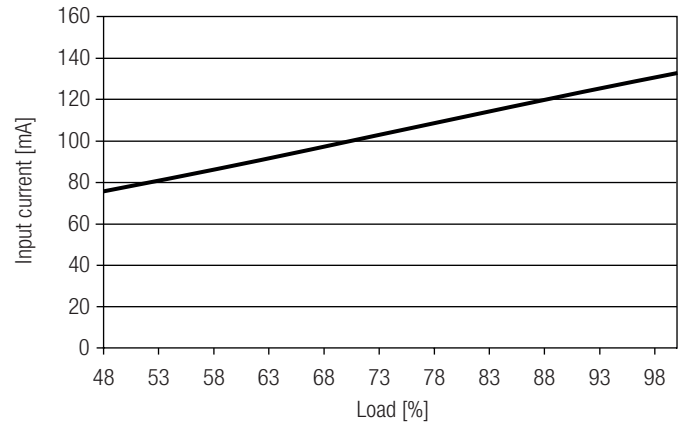

4.1.2 Power factor vs load

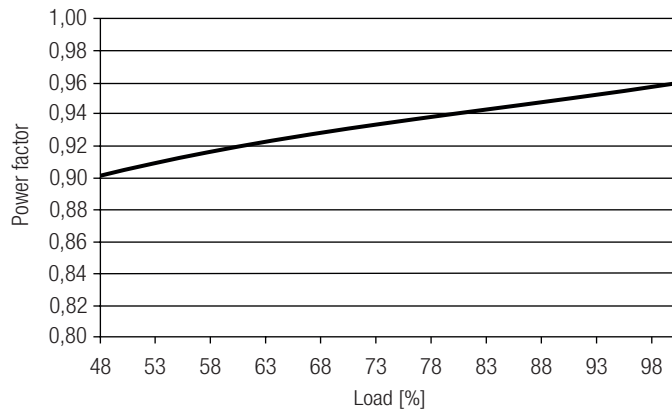

4.1.5 THD vs load

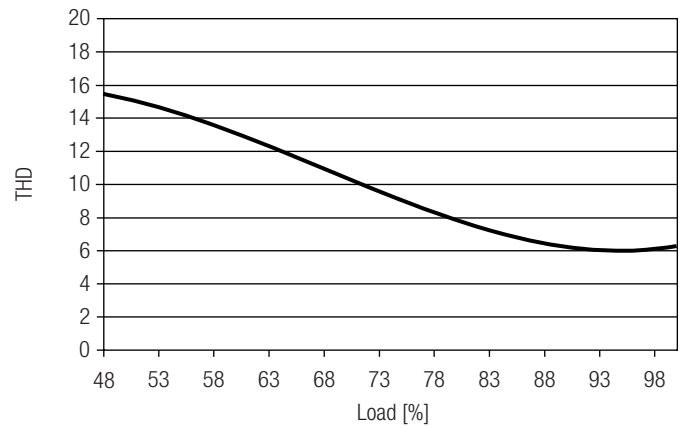

4.1.3 Input power vs load

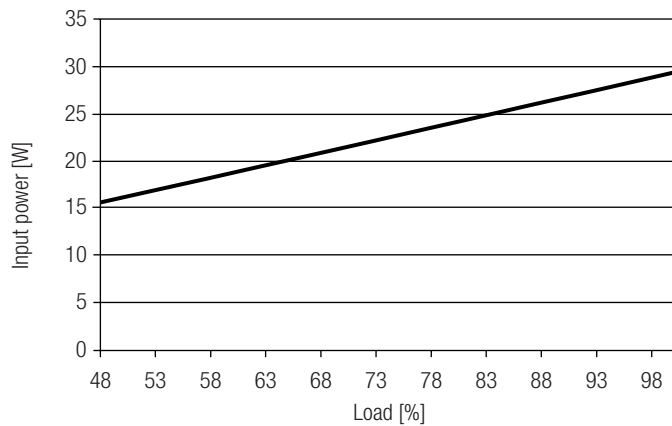

4.1.6 tc vs output voltage

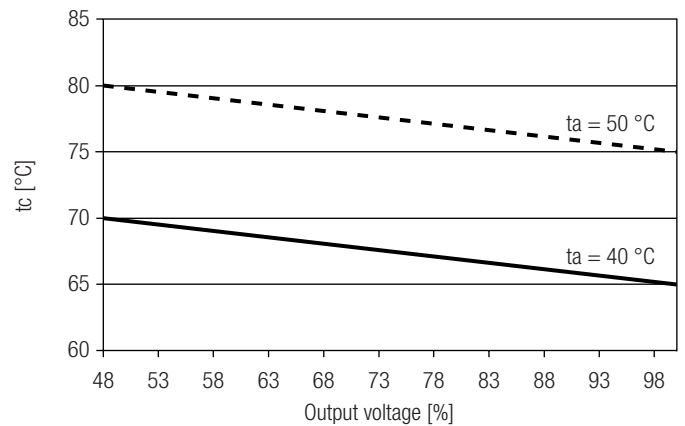

4.2 Diagrams LC 30W 700mA fixC SC ADV

4.2.1 Efficiency vs load

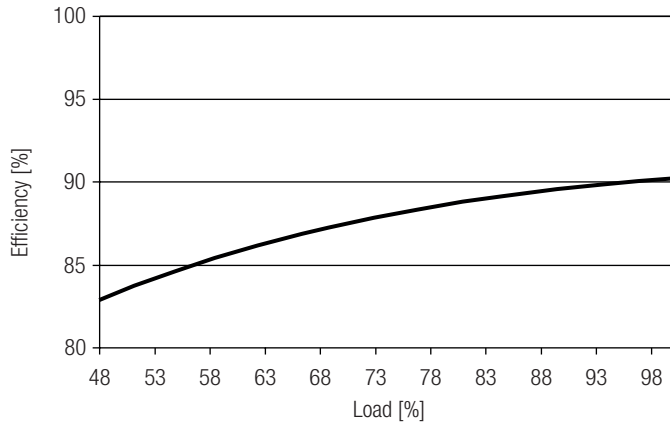

4.2.4 Input current vs load

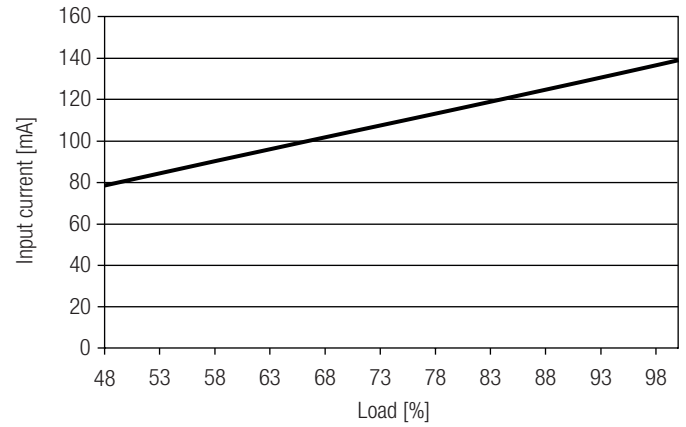

4.2.2 Power factor vs load

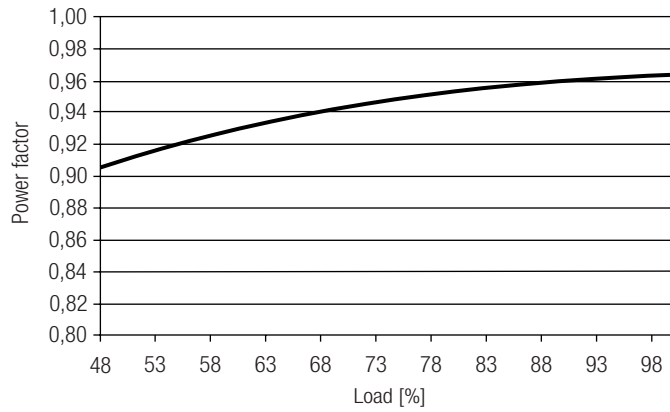

4.2.5 THD vs load

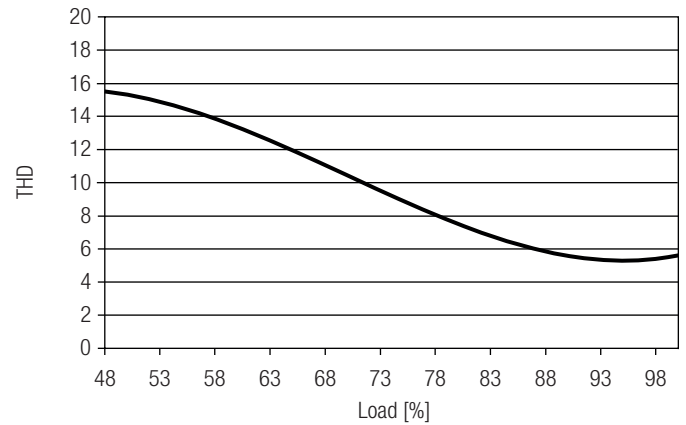

4.2.3 Input power vs load

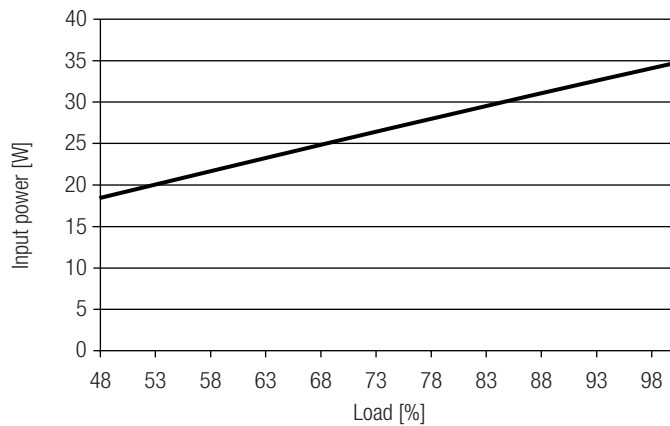

4.2.6 tc vs output voltage

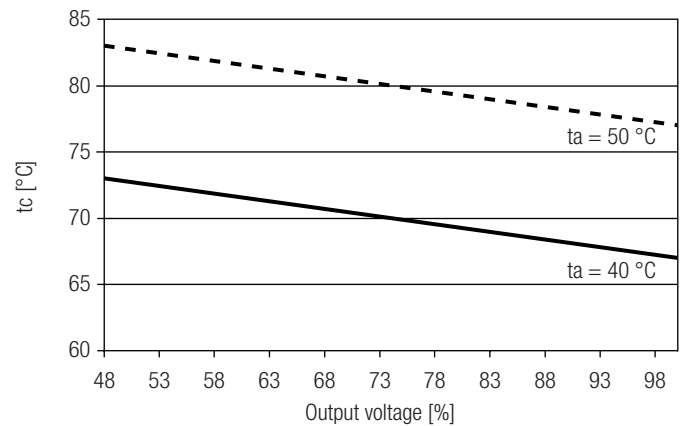

4.3 Diagrams LC 35W 700mA fixC SC ADV

4.3.1 Efficiency vs load

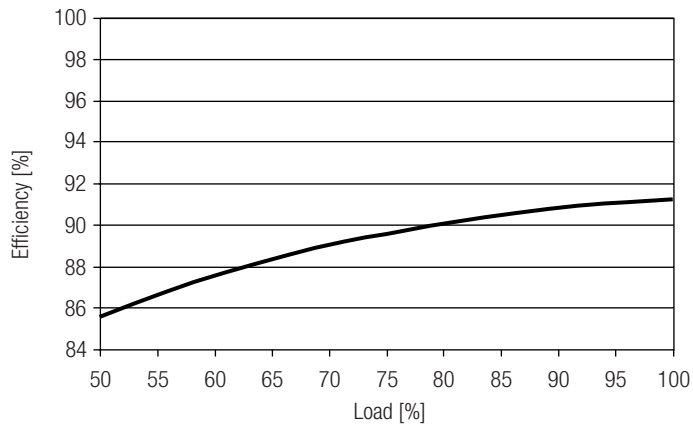

4.3.4 Input current vs load

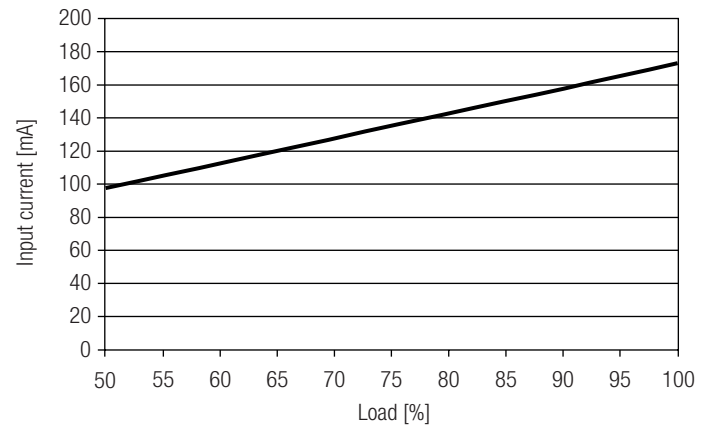

4.3.2 Power factor vs load

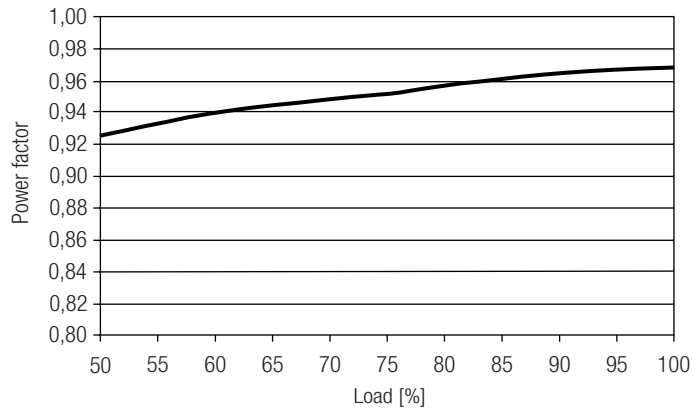

4.3.5 THD vs load

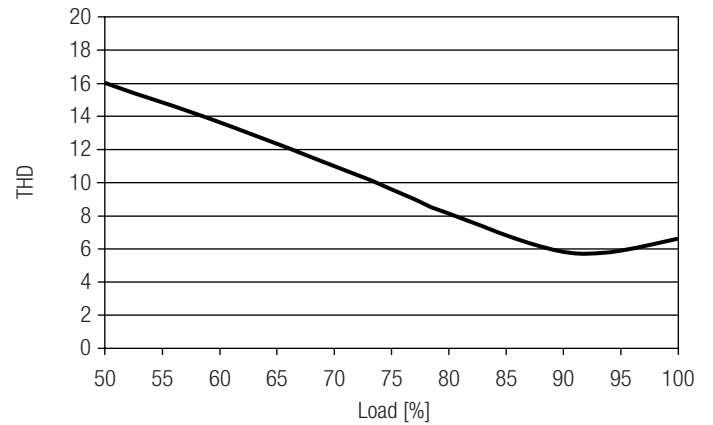

4.3.3 Input power vs load

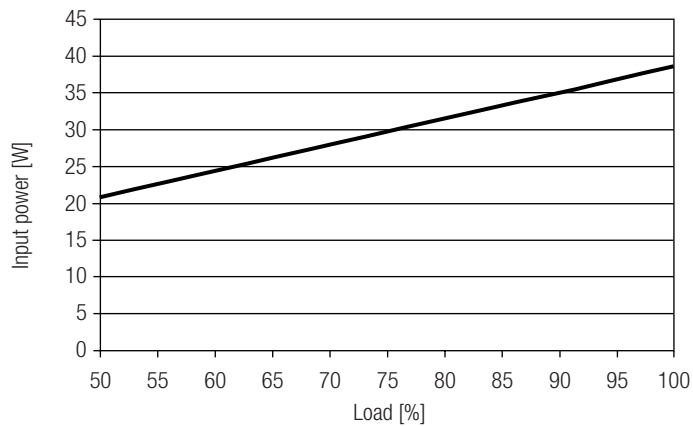

4.3.6 tc vs output voltage

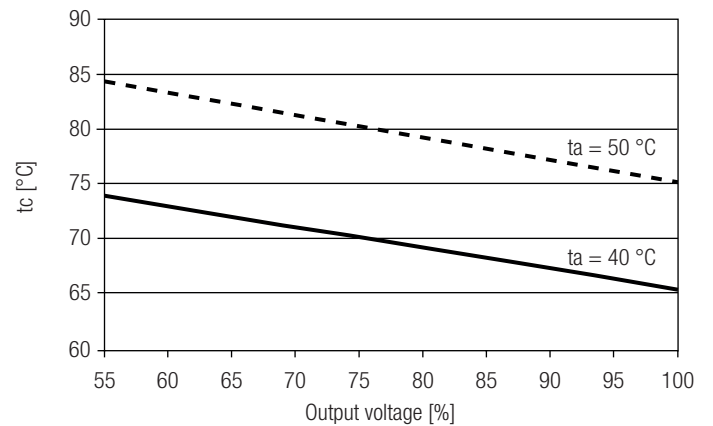

4.4 Diagrams LC 35W 800mA fixC SC ADV

4.4.1 Efficiency vs load

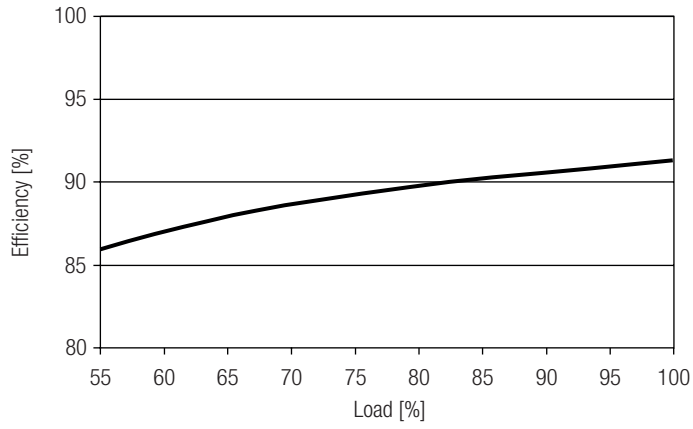

4.4.4 Input current vs load

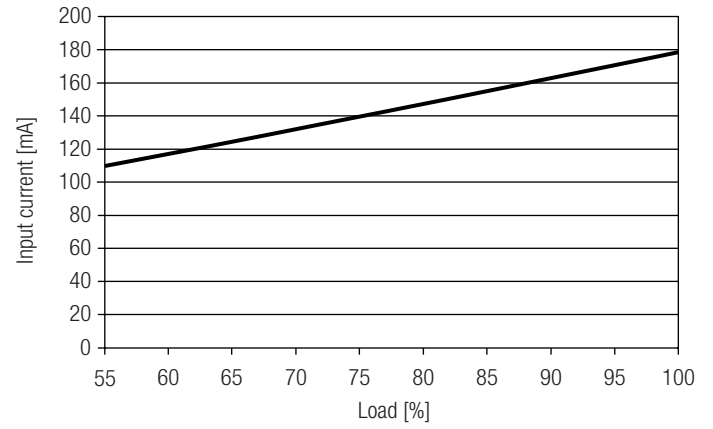

4.4.2 Power factor vs load

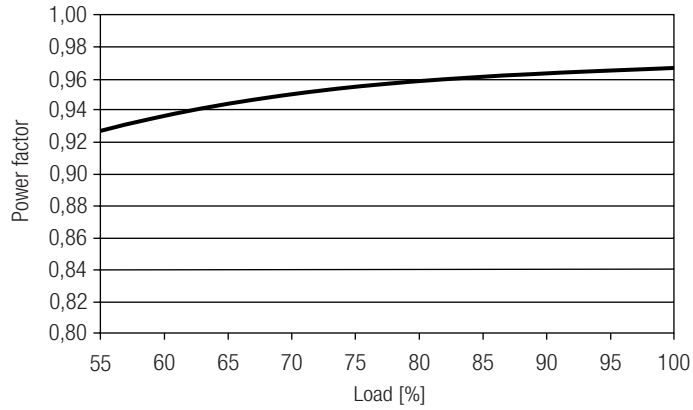

4.4.5 THD vs load

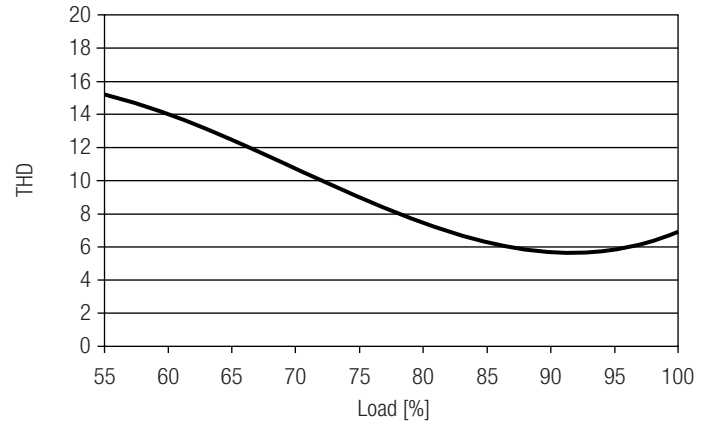

4.4.3 Input power vs load

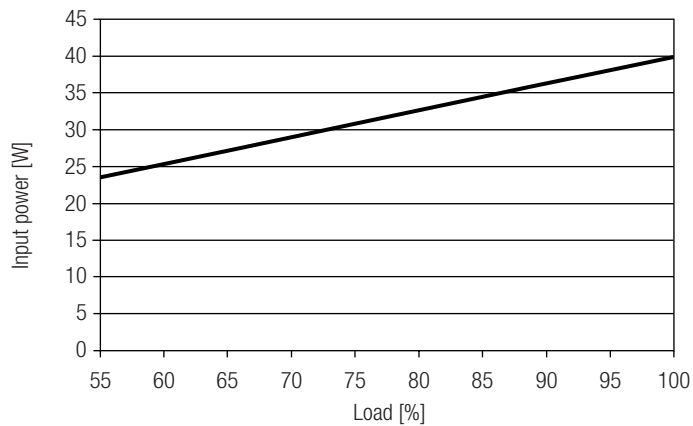

4.4.6 tc vs output voltage

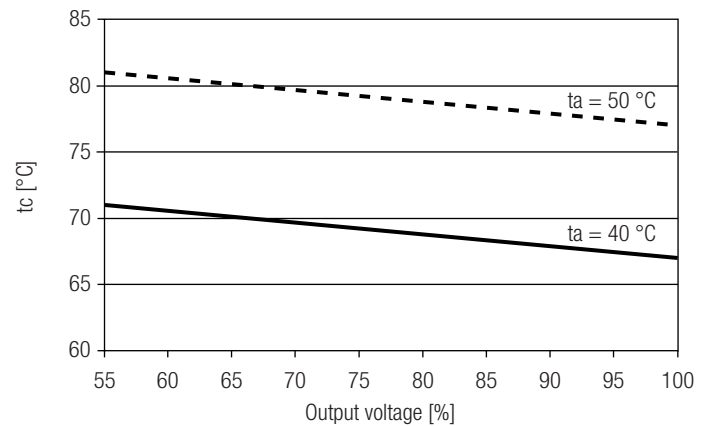

4.5 Diagrams LC 40W 900mA fixC SC ADV

4.5.1 Efficiency vs load

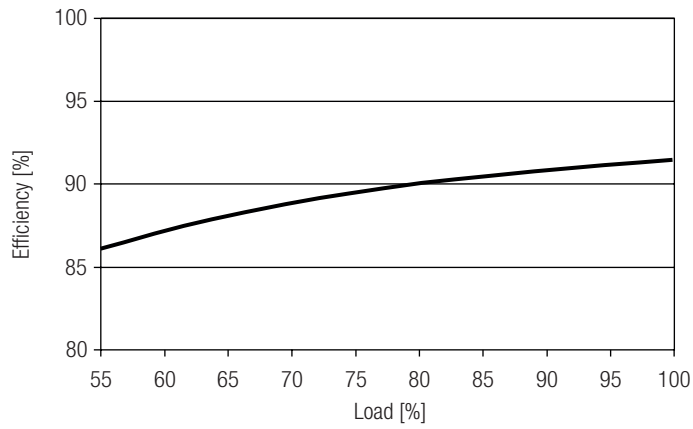

4.5.4 Input current vs load

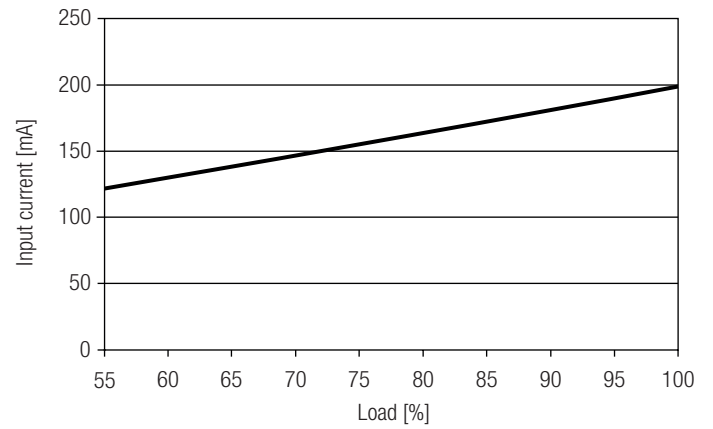

4.5.2 Power factor vs load

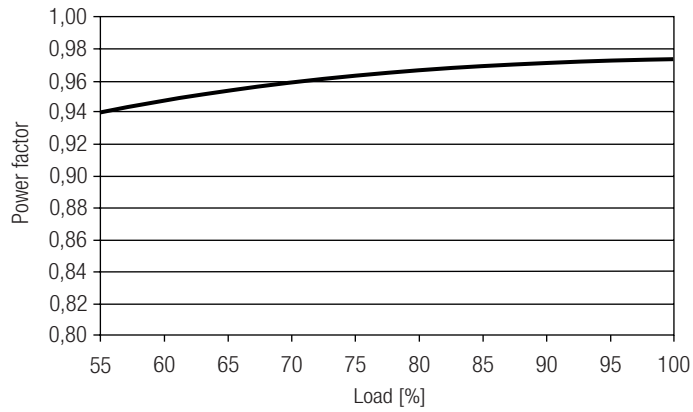

4.5.5 THD vs load

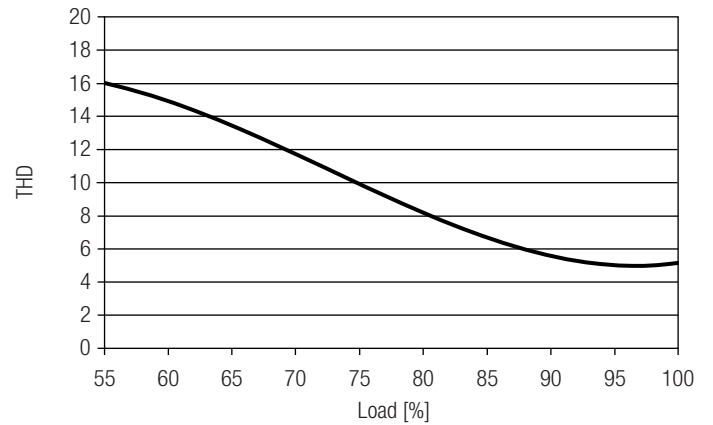

4.5.3 Input power vs load

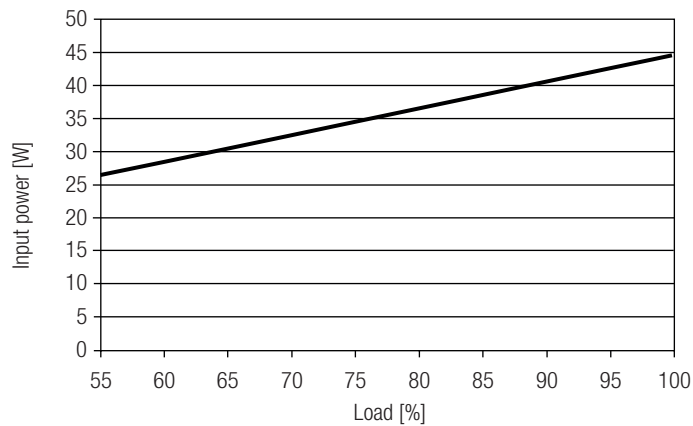

4.5.6 tc vs output voltage

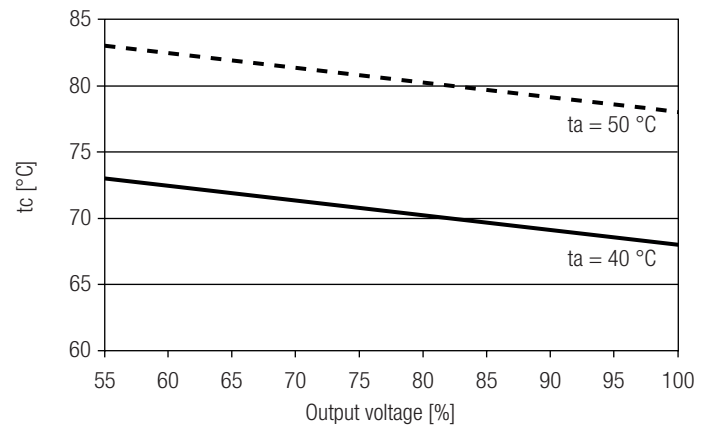

4.6 Maximum loading of automatic circuit breakers in relation to inrush current

Automatic circuit breaker type	C10	C13	C16	C20	B10	B13	B16	B20	Inrush current	
Installation Ø	1.5 mm ²	1.5 mm ²	1.5 mm ²	2.5 mm ²	1.5 mm ²	1.5 mm ²	1.5 mm ²	2.5 mm ²	I _{max}	Time
LC 25W 600mA fixC SC ADV	24	32	40	51	14	19	24	30	25 A	150 µs
LC 30W 700mA fixC SC ADV	24	32	40	51	14	19	24	30	25 A	150 µs
LC 35W 700mA fixC SC ADV	24	32	40	51	14	19	24	30	25 A	150 µs
LC 35W 800mA fixC SC ADV	24	32	40	51	14	19	24	30	25 A	150 µs
LC 40W 900mA fixC SC ADV	24	32	40	51	14	19	24	30	25 A	150 µs

This are max. values calculated out of inrush current! Please consider not to exceed the maximum rated continuous current of the circuit breaker. Calculation uses typical values from ABB series S200 as a reference. Actual values may differ due to used circuit breaker types and installation environment.

4.7 Harmonic distortion in the mains supply (at 230 V / 50 Hz and full load) in %

	THD	3.	5.	7.	9.	11.
LC 25W 600mA fixC SC ADV	< 20	< 7	< 3	< 3	< 3	< 3
LC 30W 700mA fixC SC ADV	< 20	< 7	< 3	< 3	< 3	< 3
LC 35W 700mA fixC SC ADV	< 20	< 7	< 4	< 4	< 3	< 3
LC 35W 800mA fixC SC ADV	< 20	< 7	< 3	< 3	< 3	< 3
LC 40W 900mA fixC SC ADV	< 20	< 7	< 3	< 3	< 3	< 3

5. Functions

5.1 Short-circuit behaviour

In case of a short circuit on the secondary side (LED) the LED Driver switches off. After elimination of the short-circuit fault the LED Driver will recover automatically.

5.2 No-load operation

The LED Driver will work in a pulsed light output mode to limit the output voltage lower than 60 V which allows the application to be able to work safely when LED string opens due to a failure.

5.3 Overload protection

If the output voltage range is exceeded the LED Driver reduces the LED output current. If the output voltage is exceeded by a certain degree the Driver will start working in a pulsed light output mode. After elimination of the overload the nominal operation is restored automatically.

5.4 Overtemperature protection

The LED Driver will reduce the LED output current or it works in a pulsed light output mode if the temperature reaches a certain degree.

5.5 Output over voltage protection

The LED Driver will work in a pulsed light output mode to limit the output voltage lower than 60 V, even in fault conditions.

6. Miscellaneous

6.1 Insulation and electric strength testing of luminaires

Electronic devices can be damaged by high voltage. This has to be considered during the routine testing of the luminaires in production.

According to IEC 60598-1 Annex Q (informative only!) or ENEC 303-Annex A, each luminaire should be submitted to an insulation test with 500 V_{DC} for 1 second. This test voltage should be connected between the interconnected phase and neutral terminals and the earth terminal.
The insulation resistance must be at least 2 MΩ.

As an alternative, IEC 60598-1 Annex Q describes a test of the electrical strength with 1500 V_{AC} (or 1.414 x 1500 V_{DC}). To avoid damage to the electronic devices this test must not be conducted.

6.2 Conditions of use and storage

Humidity: 5% up to max. 85 %,
not condensed
(max. 56 days/year at 85 %)

Storage temperature: -40 °C up to max. +80 °C

The devices have to be within the specified temperature range (ta) before they can be operated.

The LED Driver is declared as inbuilt LED controlgear, meaning it is intended to be used within a luminaire enclosure.

If the product is used outside a luminaire, the installation must provide suitable protection for people and environment (e.g. in illuminated ceilings).

6.3 Maximum number of switching cycles

All LED Driver are tested with 50,000 switching cycles.
The actually achieved number of switching cycles is significantly higher.

6.4 Additional information

Additional technical information at www.tridonic.com → Technical Data

Guarantee conditions at www.tridonic.com → Services

Life-time declarations are informative and represent no warranty claim.
No warranty if device was opened.