

## Connector - SACC-M12FS-4CON-PG7-M - 1681127

Please be informed that the data shown in this PDF Document is generated from our Online Catalog. Please find the complete data in the user's documentation. Our General Terms of Use for Downloads are valid (<http://phoenixcontact.com/download>)



Connector, Universal, 4-position, Socket straight M12, Coding: A, Screw connection, knurl material: Zinc die-cast, nickel-plated, cable gland Pg7, external cable diameter 4 mm ... 6 mm

### Your advantages

- ✓ Safe use in the field, thanks to a high degree of protection
- ✓ Flexible: connectors for on-site assembly
- ✓ Screw connection: proven connection technology for a large selection of different conductors

RoHS

### Key Commercial Data

Packing unit	1 pc
GTIN	 4 017918 157456
GTIN	4017918157456
Sales Key	02

### Technical data

#### Dimensions

Diameter housing	20 mm
Length	54 mm
External cable diameter	4 mm ... 6 mm
Stripping length of the sheath	20 mm
Stripping length of the individual wire	5 mm

#### Ambient conditions

Ambient temperature (operation)	-40 °C ... 85 °C (Plug / socket)
Degree of protection	IP67

#### General

Note	NOTE: Observe the permissible bending radii when laying conductors, since the degree of protection may be put in jeopardy if the bending
------	--

# Connector - SACC-M12FS-4CON-PG7-M - 1681127

## Technical data

### General

	forces are too high. Alleviate mechanical loads upstream of the connector, e.g. by using cable ties.
Rated current at 40°C	4 A
Rated voltage	250 V AC
	250 V DC
Number of positions	4
Color handle area	black
Insulation resistance	≥ 100 MΩ
Coding	A - standard
Standards/regulations	M12 connector IEC 61076-2-101
Signal type/category	Universal
Status display	No
Overvoltage category	II
Degree of pollution	3
Connection method	Screw connection
Conductor cross section	0.25 mm <sup>2</sup> ... 0.75 mm <sup>2</sup> (without ferrule)
	0.14 mm <sup>2</sup> ... 0.75 mm <sup>2</sup> (with ferrule)
	0.25 mm <sup>2</sup> ... 0.75 mm <sup>2</sup> (solid)
Conductor cross section AWG	24 ... 18 (without ferrule)
	26 ... 20 (with ferrule)
Insertion/withdrawal cycles	≥ 50
Torque	0.4 Nm (M12 knurl)
	0.2 Nm (Screw terminal blocks)
	0.8 Nm ... 1 Nm (Pressure screw with sleeve housing)
Tightening torque	Screw plug insert with sleeve housing as far it will go
Assembly instructions	The wires can be connected both with ferrules and without ferrules

### Material

Flammability rating according to UL 94	HB
Contact material	CuZn
Contact surface material	CuSnZn
Contact carrier material	PA
Material of grip body	PA
Material, knurls	Zinc die-cast, nickel-plated
Sealing material	NBR

### Standards and Regulations

Standards/specifications	M12 connector IEC 61076-2-101
Connection in acc. with standard	CUL
Flammability rating according to UL 94	HB

### Environmental Product Compliance

REACH SVHC	Lead 7439-92-1
------------	----------------

# Connector - SACC-M12FS-4CON-PG7-M - 1681127

## Technical data

### Environmental Product Compliance

China RoHS	Environmentally Friendly Use Period = 50 years
	For details about hazardous substances go to tab "Downloads", Category "Manufacturer's declaration"

## Drawings

Schematic diagram

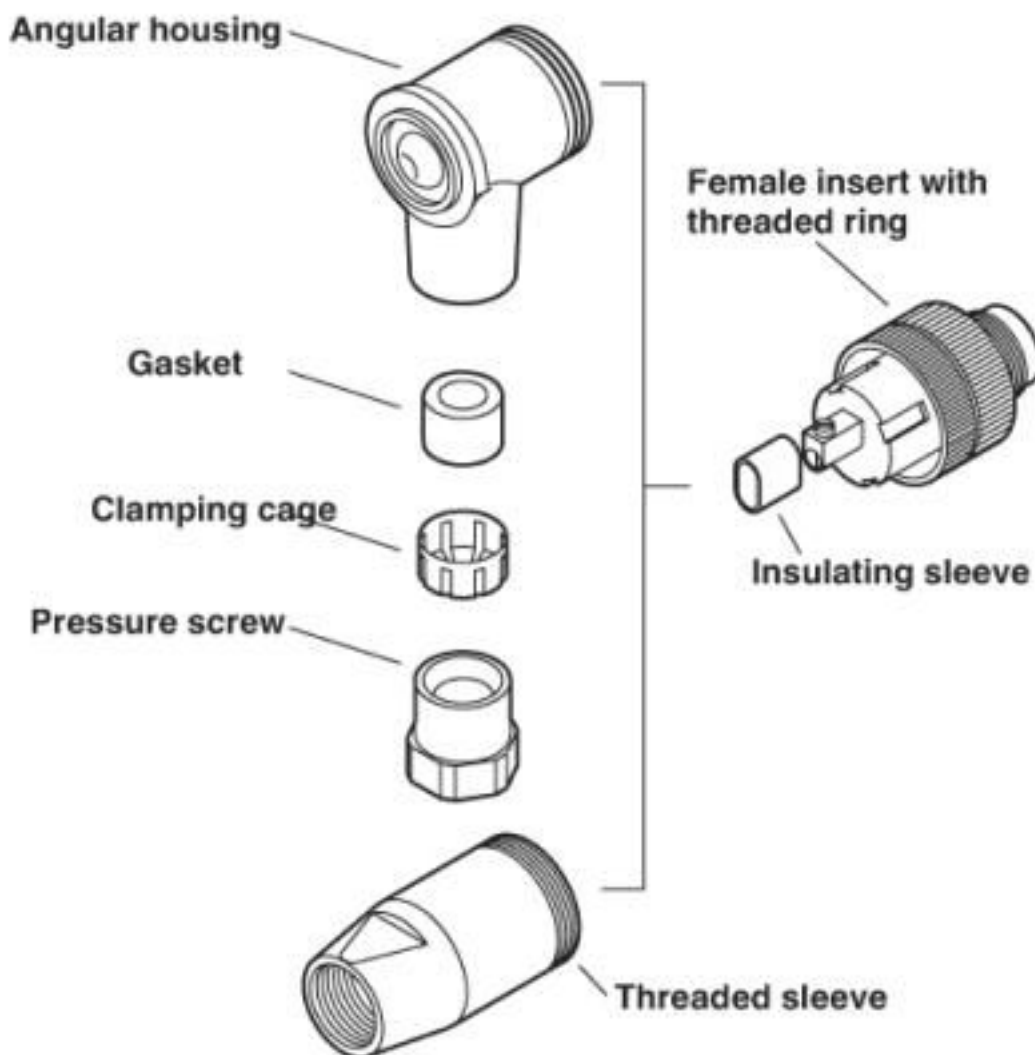

Male/Female M12

## Connector - SACC-M12FS-4CON-PG7-M - 1681127

Dimensional drawing

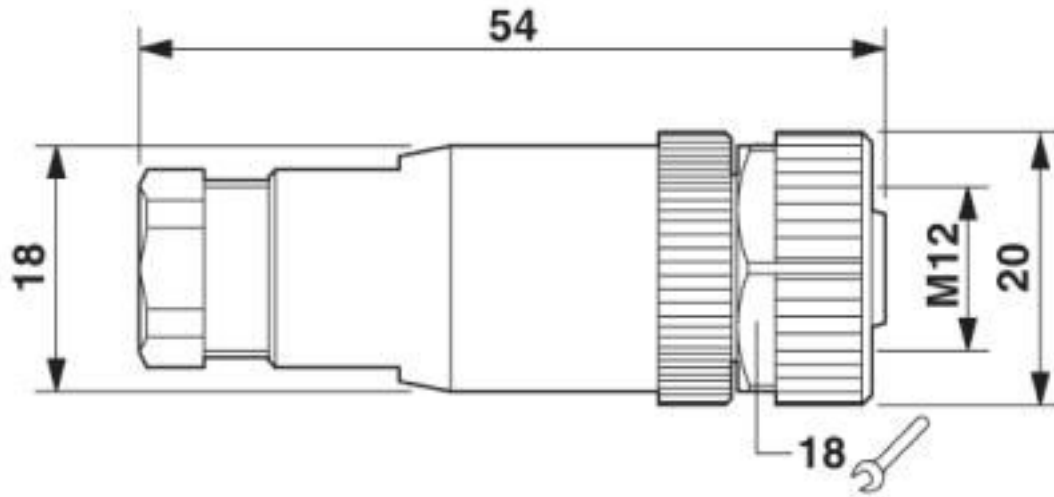

M12 x 1 socket, straight

## Connector - SACC-M12FS-4CON-PG7-M - 1681127

Schematic diagram

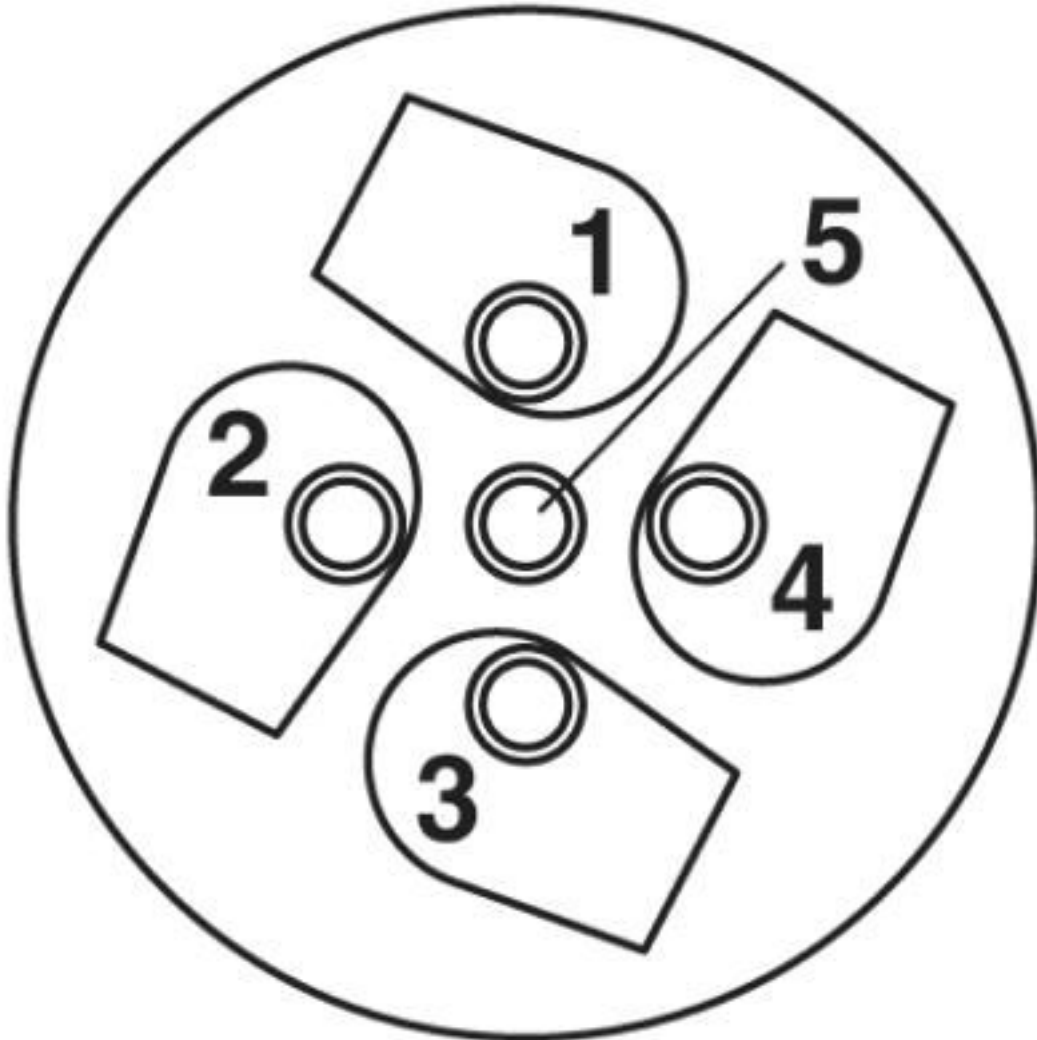

Cable connection side M12 (screw connection)

# Connector - SACC-M12FS-4CON-PG7-M - 1681127

Schematic diagram

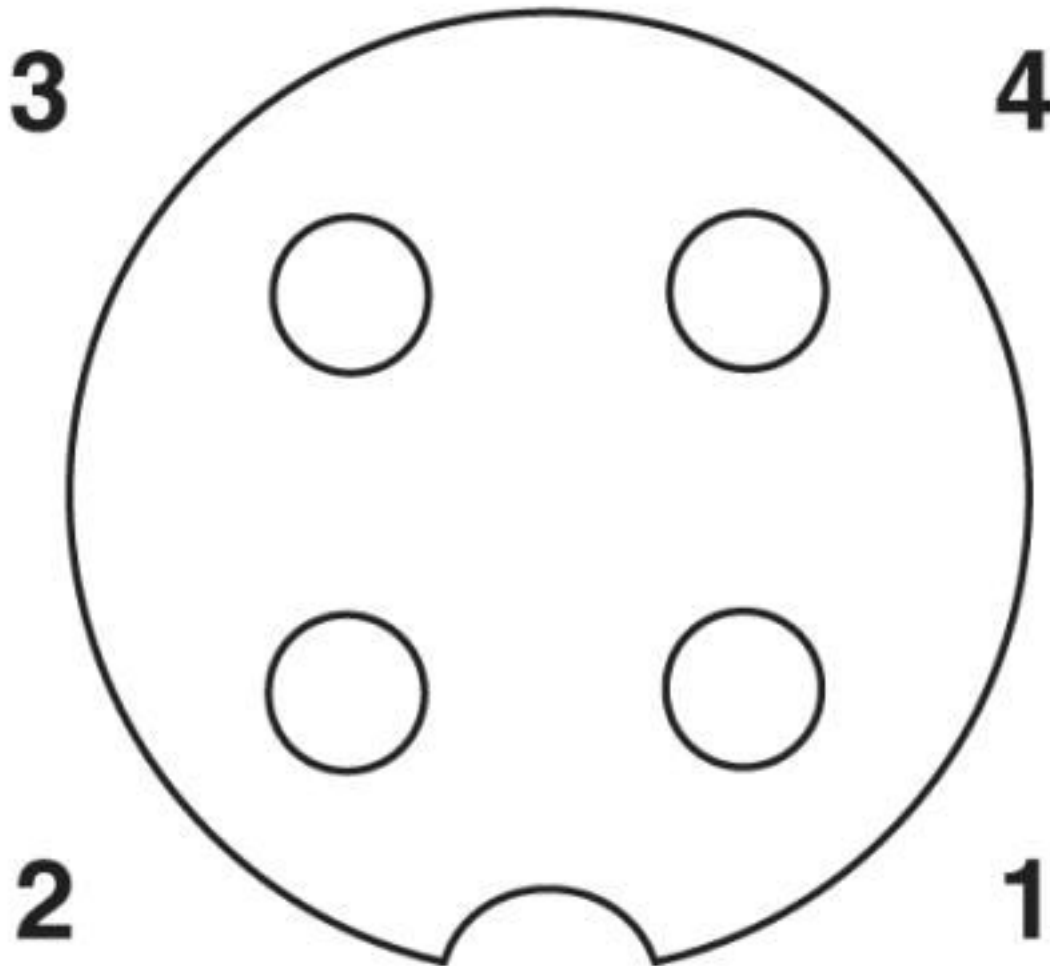

Pin assignment M12 socket, 4-pos., A-coded, view female side

## Classifications

eCl@ss

eCl@ss 10.0.1	27440102
eCl@ss 4.0	27260700
eCl@ss 4.1	27260700
eCl@ss 5.0	27260700
eCl@ss 5.1	27260700
eCl@ss 6.0	27279200
eCl@ss 7.0	27440104
eCl@ss 8.0	27440104
eCl@ss 9.0	27440102

# Connector - SACC-M12FS-4CON-PG7-M - 1681127

## Classifications

### ETIM

ETIM 2.0	EC001121
ETIM 3.0	EC002062
ETIM 4.0	EC002062
ETIM 5.0	EC002062
ETIM 6.0	EC002062

### UNSPSC

UNSPSC 6.01	31251501
UNSPSC 7.0901	31251501
UNSPSC 11	31251501
UNSPSC 12.01	31251501
UNSPSC 13.2	39121413
UNSPSC 18.0	39121413
UNSPSC 19.0	39121413
UNSPSC 20.0	39121413
UNSPSC 21.0	39121413

## Approvals

### Approvals

#### Approvals

UL Recognized / cUL Recognized / EAC / cULus Recognized

#### Ex Approvals

### Approval details

UL Recognized		<a href="http://database.ul.com/cgi-bin/XYV/template/LISEXT/1FRAME/index.htm">http://database.ul.com/cgi-bin/XYV/template/LISEXT/1FRAME/index.htm</a>	FILE E 221474
Nominal voltage UN	250 V		
Nominal current IN	4 A		

cUL Recognized		<a href="http://database.ul.com/cgi-bin/XYV/template/LISEXT/1FRAME/index.htm">http://database.ul.com/cgi-bin/XYV/template/LISEXT/1FRAME/index.htm</a>	FILE E 221474
Nominal voltage UN	250 V		

# Connector - SACC-M12FS-4CON-PG7-M - 1681127

## Approvals

Nominal current I <sub>N</sub>	4 A
--------------------------------	-----

EAC		RU C- DE.BL08.B.00511
-----	--	--------------------------

cULus Recognized	
------------------	--

## Accessories

### Accessories

#### Cable by the meter

Cable reel - SAC-4P-100,0-PUR/0,25 - 1501692



By the meter, Cable reel, PUR halogen-free, black-gray RAL 7021, 4-wire, color single wire: brown, white, blue, black, cable length: 100 m

Cable reel - SAC-4P-100,0-PUR/0,34 - 1501663



By the meter, Cable reel, PUR halogen-free, black-gray RAL 7021, 4-wire, color single wire: brown, white, blue, black, cable length: 100 m

Cable reel - SAC-4P-100,0-186/0,75 - 1457461



By the meter, Cable reel, PUR, black-gray RAL 7021, 4-wire, color single wire: brown, white, blue, black, cable length: 100 m

#### Cable end sleeve



## Connector - SACC-M12FS-4CON-PG7-M - 1681127

### Accessories

Ferrule - A 0,25- 5 - 3202465



Ferrule, length: 5 mm, color: silver

---

### Crimping tool

Crimping pliers - CRIMPFOX 6H - 1212046



Crimping pliers, for ferrules without insulating collar according to DIN 46228 Part 1 and ferrules with insulating collar according to DIN 46228 Part 4, 0.14 mm<sup>2</sup> ... 6 mm<sup>2</sup>, unlockable pressure lock, lateral entry

---

### Plug for cable screw gland

Screw plug - PROT-M12 MS-PA-CHAIN - 1430899

M12 sealing cap with fixing band, for sensor cables, for free M12 sockets



---

### Screwdriver tools

Adapter insert - TSD-M SAC-BIT ADAPTER - 1212600



Adapter bit for TSD-M...torque tools, E6.3-1/4" drive with 4 mm hexagon to accommodate SAC bits

---

Tool - SACC BIT M12-D20 - 1208445



Nut for assembling M12 connectors for assembly with a knurl diameter of 20 mm, for 4 mm hexagonal drive

## Connector - SACC-M12FS-4CON-PG7-M - 1681127

### Accessories

Screwdriver - SZF 1-0,6X3,5 - 1204517



Actuation tool, for ST terminal blocks, also suitable for use as a bladed screwdriver, size: 0.6 x 3.5 x 100 mm, 2-component grip, with non-slip grip

---

### Seal

Connector - SACC-M12-SET/2,5-3,5 - 1436505



Sensor/actuator connector, accessories, pressure screw and Pg7 seal, for unshielded M12 connector, cable diameter 2.5 mm - 3.5 mm

---

### Torque tool

Torque screwdriver - TSD 04 SAC - 1208429



Torque screwdriver, with preset torque of 0.4 Nm and 4 mm hexagonal drive for M12 connectors

---

Torque screwdriver - TSD-M 1,2NM - 1212224



Torque screw driver, accuracy as per EN ISO 6789 standard, adjustable from 0.3 - 1.2 Nm

# Mouser Electronics

Authorized Distributor

Click to View Pricing, Inventory, Delivery & Lifecycle Information:

[Phoenix Contact:](#)

[1681127](#)