

UNO® UNIVERSAL PLUG WITH SCREW

Truly universal plug with screw which fixes into any base material, solid or hollow



Product information

Features and benefits

- Recommended for unknown substrates and exploited holes.
- Short length enables successful use in thin walls.
- Unique geometry guarantees maximum expansion and grip.
- 100% assurance of proper anchoring derived from unique split design of the plug in it's top part.
- Anti-rotation features prevent spinning in the hole.
- Lip prevents plug slipping into over-sized holes.

Applications

- Shelves
- Suspended ceilings
- Electrical fittings
- Cable trays
- Boilers
- Radiators
- Lighting
- Bathroom fittings

Base materials

- Suitable for use in**
- Concrete
 - Solid Brick
 - Solid Sand-lime Brick
 - Vertically-perforated Clay Block
 - Hollow Sand-lime Brick
 - Aerated Concrete Block
 - Plasterboard

Installation guide

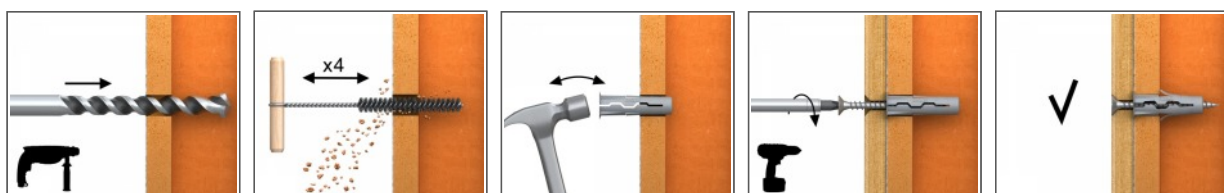

1. Drill a hole of required diameter.
2. Insert UNO plug into hole and tap home.
3. Insert screw of required diameter into plug through fixture and tighten.

Product information

Size	Product Code	Plug		Screw		Fixture	
		Diameter	Length	Diameter	Length	Max. thickness	Hole diameter
		d	l	D	L	t _{fix}	d _f
[mm]							
Ø5	UNO-05+330	5	24	3,5	30	6	6
Ø6	UNO-06+430	6	28	4,0	30	1	5
	UNO-06+435	6	28	4,0	35	5	5
	UNO-06+445	6	28	4,0	45	15	6
Ø8	UNO-08+435	8	32	4,5	35	2	5
	UNO-08+450	8	32	4,5	50	15	6
	UNO-08+560	8	32	5,0	60	25	7
Ø10	UNO-10+540	10	36	5,0	40	2	6
	UNO-10+650	10	36	6,0	50	15	7
	UNO-10+660	10	36	6,0	60	25	9

Installation data

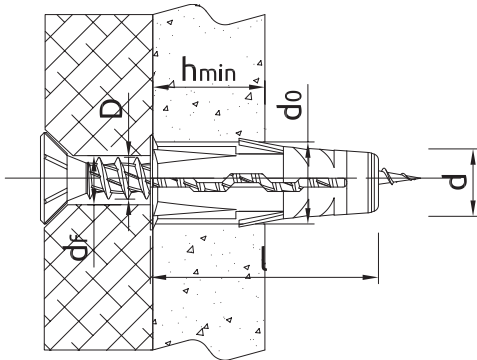

Installation data in hollow substrates

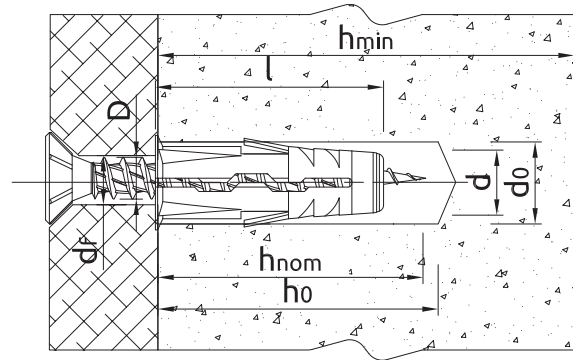

Installation data in solid substrates

Size			Ø5	Ø6	Ø8	Ø10
Fixing diameter	d	[mm]	5	6	8	10
Hole diameter in substrate	d ₀	[mm]	5	6	8	10
Min. hole depth in substrate	h ₀	[mm]	34	38	42	46
Min. installation depth	h _{nom}	[mm]	24	28	32	36
Min. substrate thickness	h _{min}	[mm]	50	55	65	70
Min. spacing	s _{min}	[mm]	24	28	32	36
Min. edge distance	c _{min}	[mm]	24	28	32	36

Basic performance data

Performance data for single fixing without influence of edge distance and spacing

Substrate		Concrete C20/25	Solid brick	Sand-lime solid brick	Perforated ceramic brick	Sand-lime hollow brick	Plasterboard min. 12.5 mm
CHARACTERISTIC LOAD F_{Rk}							
Ø5, Embedment depth 24mm	[kN]	0.60	1.50	1.50	0.60	1.50	0.17
Ø6, Embedment depth 28mm	[kN]	1.20	2.50	1.50	0.75	1.50	0.21
Ø8, Embedment depth 32mm	[kN]	1.20	3.00	2.50	0.90	1.50	0.37
Ø10, Embedment depth 36mm	[kN]	2.50	4.00	0.90	0.90	1.20	0.34
DESIGN LOAD F_{Rd}							
Ø5, Embedment depth 24mm	[kN]	0.33	0.60	0.60	0.24	0.60	0.08
Ø6, Embedment depth 28mm	[kN]	0.66	1.00	0.60	0.30	0.60	0.10
Ø8, Embedment depth 32mm	[kN]	0.66	1.20	1.00	0.36	0.60	0.18
Ø10, Embedment depth 36mm	[kN]	1.38	1.60	0.36	0.36	0.48	0.17

Basic performance data

Substrate		Concrete C20/25	Solid brick	Sand-lime solid brick	Perforated ceramic brick	Sand-lime hollow brick	Plasterboard min. 12.5 mm
RECOMMENDED LOAD F_{rec}							
Ø5, Embedment depth 24mm	[kN]	0.24	0.43	0.43	0.17	0.43	0.06
Ø6, Embedment depth 28mm	[kN]	0.47	0.71	0.43	0.21	0.43	0.07
Ø8, Embedment depth 32mm	[kN]	0.47	0.86	0.71	0.26	0.43	0.13
Ø10, Embedment depth 36mm	[kN]	0.99	1.14	0.26	0.26	0.29	0.12

Product commercial data

Product Code	Plug	Quantity [pcs]			Weight [kg]			Bar Codes
	Diameter [mm]	Box	Outer	Pallet	Box	Outer	Pallet	
UNO-05+330	5	100	3200	76800	0.19	6.0	174.4	5906675199627
UNO-06+430	6	100	3200	76800	0.27	8.5	234.4	5906675250236
UNO-06+435	6	100	3200	76800	0.30	9.5	258.0	5906675199641
UNO-06+445	6	100	3200	76800	0.33	10.5	281.0	5906675199634
UNO-08+435	8	100	1600	38400	0.47	7.5	208.7	5906675250243
UNO-08+450	8	100	1600	38400	0.51	8.2	227.4	5906675199658
UNO-08+560	8	100	1600	38400	0.67	10.7	287.7	5906675199665
UNO-10+540	10	100	1600	16000	0.60	9.7	126.5	5906675250250
UNO-10+650	10	100	1600	38400	0.90	14.4	376.5	5906675199672
UNO-10+660	10	100	1600	38400	1.81	29.0	725.0	5906675199689