

# MJE18004, MJF18004

## Switch-mode NPN Bipolar Power Transistor For Switching Power Supply Applications

The MJE/MJF18004 have an applications specific state-of-the-art die designed for use in 220 V line-operated switch-mode Power supplies and electronic light ballasts.

### Features

- Improved Efficiency Due to Low Base Drive Requirements:
  - ◆ High and Flat DC Current Gain  $h_{FE}$
  - ◆ Fast Switching
  - ◆ No Coil Required in Base Circuit for Turn-Off (No Current Tail)
- Full Characterization at 125°C
- ON Semiconductor Six Sigma Philosophy Provides Tight and Reproducible Parametric Distributions
- Two Package Choices: Standard TO-220 or Isolated TO-220
- MJF18004, Case 221D, is UL Recognized at 3500 V<sub>RMS</sub>: File #E69369
- These Devices are Pb-Free and are RoHS Compliant\*

### MAXIMUM RATINGS

Rating	Symbol	Value	Unit
Collector-Emitter Sustaining Voltage	$V_{CEO}$	450	Vdc
Collector-Base Breakdown Voltage	$V_{CES}$	1000	Vdc
Emitter-Base Voltage	$V_{EBO}$	9.0	Vdc
Collector Current – Continuous	$I_C$	5.0	Adc
Collector Current – Peak (Note 1)	$I_{CM}$	10	Adc
Base Current – Continuous	$I_B$	2.0	Adc
Base Current – Peak (Note 1)	$I_{BM}$	4.0	Adc
RMS Isolation Voltage (Note 2) Test No. 1 Per Figure 22a Test No. 2 Per Figure 22b Test No. 3 Per Figure 22c (for 1 sec, R.H. < 30%, $T_A = 25^\circ\text{C}$ )	$V_{ISOL}$	<b>MJF18004</b> 4500 3500 1500	V
Total Device Dissipation @ $T_C = 25^\circ\text{C}$ MJE18004 MJF18004	$P_D$	75 35	W W/°C
Derate above 25°C MJE18004 MJF18004		0.6 0.28	
Operating and Storage Temperature	$T_J, T_{stg}$	-65 to 150	°C

### THERMAL CHARACTERISTICS

Characteristics	Symbol	Max	Unit
Thermal Resistance, Junction-to-Case MJE18004 MJF18004	$R_{\theta JC}$	1.65 3.55	°C/W
Thermal Resistance, Junction-to-Ambient	$R_{\theta JA}$	62.5	°C/W
Maximum Lead Temperature for Soldering Purposes 1/8" from Case for 5 Seconds	$T_L$	260	°C

Stresses exceeding those listed in the Maximum Ratings table may damage the device. If any of these limits are exceeded, device functionality should not be assumed, damage may occur and reliability may be affected.

1. Pulse Test: Pulse Width = 5 ms, Duty Cycle ≤ 10%.
2. Proper strike and creepage distance must be provided.



ON Semiconductor®

[www.onsemi.com](http://www.onsemi.com)

**POWER TRANSISTOR**  
**5.0 AMPERES**  
**1000 VOLTS**  
**35 and 75 WATTS**

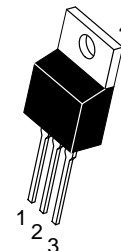
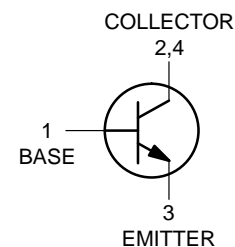

**TO-220AB**  
**CASE 221A-09**  
**STYLE 1**

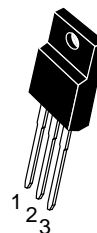

**TO-220 FULLPACK**  
**CASE 221D**  
**STYLE 2**  
**UL RECOGNIZED**

G = Pb-Free Package  
A = Assembly Location  
Y = Year  
WW = Work Week

### MARKING DIAGRAMS

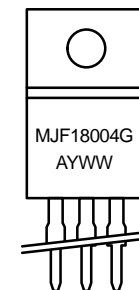
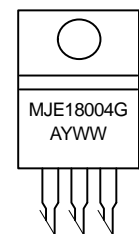

### ORDERING INFORMATION

See detailed ordering and shipping information in the package dimensions section on page 8 of this data sheet.

\*For additional information on our Pb-Free strategy and soldering details, please download the ON Semiconductor Soldering and Mounting Techniques Reference Manual, SOLDERRM/D.

# MJE18004, MJF18004

## ELECTRICAL CHARACTERISTICS ( $T_C = 25^\circ\text{C}$ unless otherwise specified)

Characteristic	Symbol	Min	Typ	Max	Unit
----------------	--------	-----	-----	-----	------

### OFF CHARACTERISTICS

Collector–Emitter Sustaining Voltage ( $I_C = 100\text{ mA}$ , $L = 25\text{ mH}$ )	$V_{CEO(sus)}$	450	–	–	Vdc
Collector Cutoff Current ( $V_{CE} = \text{Rated } V_{CEO}$ , $I_B = 0$ )	$I_{CEO}$	–	–	100	$\mu\text{Adc}$
Collector Cutoff Current ( $V_{CE} = \text{Rated } V_{CES}$ , $V_{EB} = 0$ ) ( $V_{CE} = 800\text{ V}$ , $V_{EB} = 0$ )	$I_{CES}$	–	–	100 500 100	$\mu\text{Adc}$
					(T <sub>C</sub> = 25°C) (T <sub>C</sub> = 125°C) (T <sub>C</sub> = 125°C)
Emitter Cutoff Current ( $V_{EB} = 9.0\text{ Vdc}$ , $I_C = 0$ )	$I_{EBO}$	–	–	100	$\mu\text{Adc}$

### ON CHARACTERISTICS

Base–Emitter Saturation Voltage ( $I_C = 1.0\text{ Adc}$ , $I_B = 0.1\text{ Adc}$ ) ( $I_C = 2.0\text{ Adc}$ , $I_B = 0.4\text{ Adc}$ )	$V_{BE(sat)}$	–	0.82 0.92	1.1 1.25	Vdc
Collector–Emitter Saturation Voltage ( $I_C = 1.0\text{ Adc}$ , $I_B = 0.1\text{ Adc}$ )  ( $I_C = 2.0\text{ Adc}$ , $I_B = 0.4\text{ Adc}$ )  ( $I_C = 2.5\text{ Adc}$ , $I_B = 0.5\text{ Adc}$ )	$V_{CE(sat)}$	–	0.25 0.29 0.3 0.36 0.5	0.5 0.6 0.45 0.8 0.75	Vdc
					(T <sub>C</sub> = 125°C) (T <sub>C</sub> = 125°C) (T <sub>C</sub> = 125°C)
DC Current Gain ( $I_C = 1.0\text{ Adc}$ , $V_{CE} = 2.5\text{ Vdc}$ )  ( $I_C = 0.3\text{ Adc}$ , $V_{CE} = 5.0\text{ Vdc}$ )  ( $I_C = 2.0\text{ Adc}$ , $V_{CE} = 1.0\text{ Vdc}$ )  ( $I_C = 10\text{ mAdc}$ , $V_{CE} = 5.0\text{ Vdc}$ )	$h_{FE}$	12	21 20 14 32 6.0 7.5 10	– – 34 – – – –	–
					(T <sub>C</sub> = 125°C) (T <sub>C</sub> = 125°C) (T <sub>C</sub> = 125°C)

### DYNAMIC CHARACTERISTICS

Current Gain Bandwidth ( $I_C = 0.5\text{ Adc}$ , $V_{CE} = 10\text{ Vdc}$ , $f = 1.0\text{ MHz}$ )	$f_T$	–	13	–	MHz
Output Capacitance ( $V_{CB} = 10\text{ Vdc}$ , $I_E = 0$ , $f = 1.0\text{ MHz}$ )	$C_{ob}$	–	50	65	pF
Input Capacitance ( $V_{EB} = 8.0\text{ V}$ )	$C_{ib}$	–	800	1000	pF
Dynamic Saturation Voltage:  Determined 1.0 $\mu\text{s}$ and 3.0 $\mu\text{s}$ respectively after rising $I_{B1}$ reaches 90% of final $I_{B1}$ (see Figure 18)	$V_{CE(dsat)}$	–	6.8 14 2.4 5.6 11.3 15.5 1.3 6.1	– – – – – – – –	Vdc
					(I <sub>C</sub> = 1.0 Adc, I <sub>B1</sub> = 100 mAdc, V <sub>CC</sub> = 300 V) (I <sub>C</sub> = 2.0 Adc, I <sub>B1</sub> = 400 mAdc, V <sub>CC</sub> = 300 V)
					1.0 $\mu\text{s}$ (T <sub>C</sub> = 125°C) 3.0 $\mu\text{s}$ (T <sub>C</sub> = 125°C) 1.0 $\mu\text{s}$ (T <sub>C</sub> = 125°C) 3.0 $\mu\text{s}$ (T <sub>C</sub> = 125°C)

# MJE18004, MJF18004

## ELECTRICAL CHARACTERISTICS — continued ( $T_C = 25^\circ\text{C}$ unless otherwise specified)

Characteristic	Symbol	Min	Typ	Max	Unit
----------------	--------	-----	-----	-----	------

### SWITCHING CHARACTERISTICS: Resistive Load ( $D.C. \leq 10\%$ , Pulse Width = 20 $\mu\text{s}$ )

Turn-On Time	( $I_C = 1.0 \text{ Adc}$ , $I_{B1} = 0.1 \text{ Adc}$ , $I_{B2} = 0.5 \text{ Adc}$ , $V_{CC} = 300 \text{ V}$ ) ( $T_C = 125^\circ\text{C}$ )	$t_{on}$	–	210 180	300 –	ns
Turn-Off Time		$t_{off}$	–	1.0 1.3	1.7 –	$\mu\text{s}$
Turn-On Time	( $I_C = 2.0 \text{ Adc}$ , $I_{B1} = 0.4 \text{ Adc}$ , $I_{B1} = 1.0 \text{ Adc}$ , $V_{CC} = 300 \text{ V}$ ) ( $T_C = 125^\circ\text{C}$ )	$t_{on}$	–	75 90	110 –	ns
Turn-Off Time		$t_{off}$	–	1.5 1.8	2.5 –	$\mu\text{s}$
Turn-On Time	( $I_C = 2.5 \text{ Adc}$ , $I_{B1} = 0.5 \text{ Adc}$ , $I_{B2} = 0.5 \text{ Adc}$ , $V_{CC} = 250 \text{ V}$ ) ( $T_C = 125^\circ\text{C}$ )	$t_{on}$	–	450 900	800 1400	ns
Storage Time		$t_s$	–	2.0 2.2	3.0 3.5	$\mu\text{s}$
Fall Time		$t_f$	–	275 500	400 800	ns

### SWITCHING CHARACTERISTICS: Inductive Load ( $V_{clamp} = 300 \text{ V}$ , $V_{CC} = 15 \text{ V}$ , $L = 200 \mu\text{H}$ )

Fall Time	( $I_C = 1.0 \text{ Adc}$ , $I_{B1} = 0.1 \text{ Adc}$ , $I_{B2} = 0.5 \text{ Adc}$ ) ( $T_C = 125^\circ\text{C}$ )	$t_{fi}$	–	100 100	150 –	ns
Storage Time		$t_{si}$	–	1.1 1.4	1.7 –	$\mu\text{s}$
Crossover Time		$t_c$	–	180 160	250 –	ns
Fall Time	( $I_C = 2.0 \text{ Adc}$ , $I_{B1} = 0.4 \text{ Adc}$ , $I_{B2} = 1.0 \text{ Adc}$ ) ( $T_C = 125^\circ\text{C}$ )	$t_{fi}$	–	90 150	175 –	ns
Storage Time		$t_{si}$	–	1.7 2.2	2.5 –	$\mu\text{s}$
Crossover Time		$t_c$	–	180 250	300 –	ns
Fall Time	( $I_C = 2.5 \text{ Adc}$ , $I_{B1} = 0.5 \text{ Adc}$ , $I_{B2} = 0.5 \text{ Adc}$ , $V_{BE(off)} = -5.0 \text{ Vdc}$ ) ( $T_C = 125^\circ\text{C}$ )	$t_{fi}$	–	70 100	130 175	ns
Storage Time		$t_{si}$	–	0.75 1.0	1.0 1.3	$\mu\text{s}$
Crossover Time		$t_c$	–	250 250	350 500	ns

TYPICAL STATIC CHARACTERISTICS

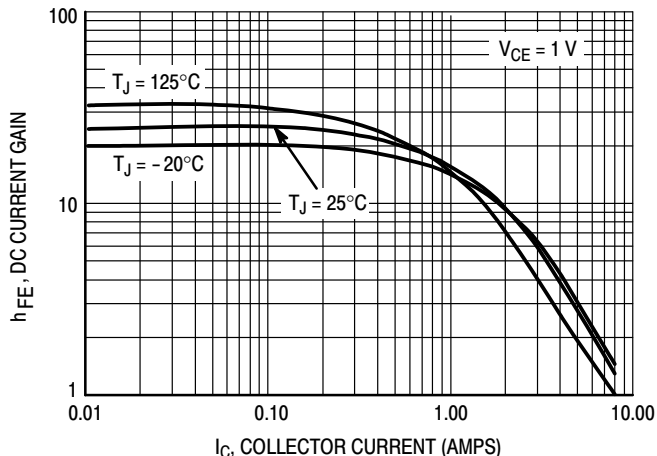

Figure 1. DC Current Gain @ 1 Volt

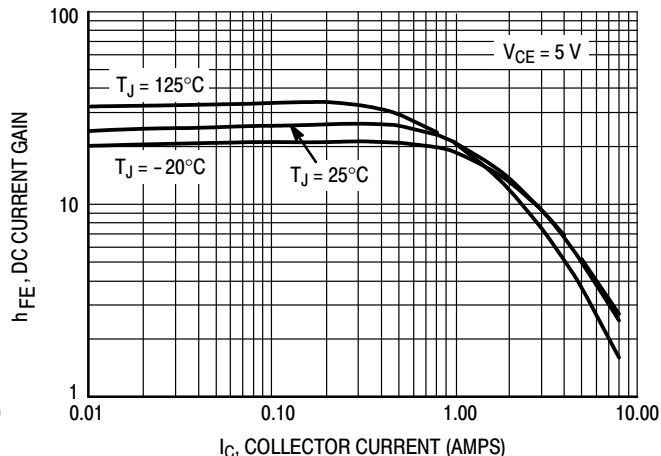

Figure 2. DC Current Gain @ 5 Volts

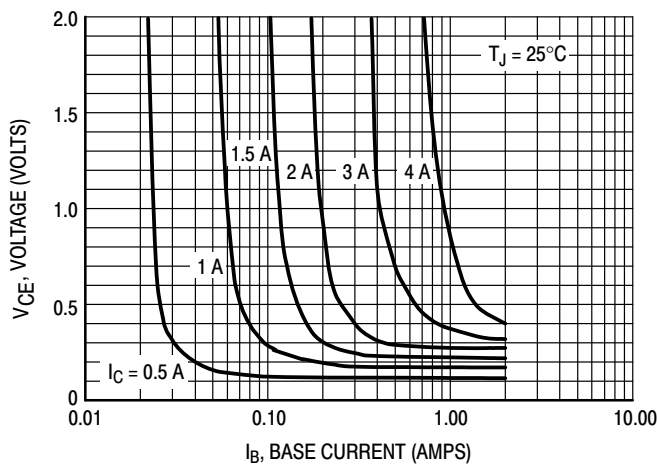

Figure 3. Collector Saturation Region

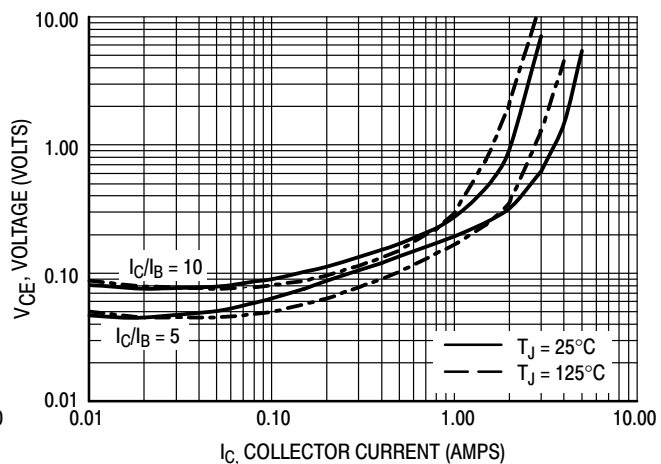

Figure 4. Collector-Emitter Saturation Voltage

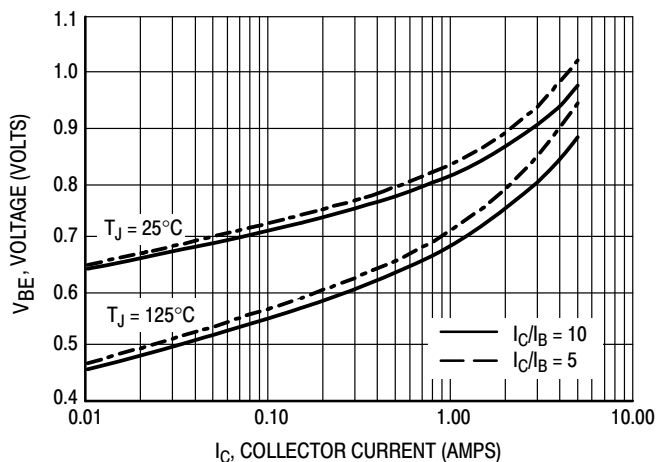

Figure 5. Base-Emitter Saturation Region

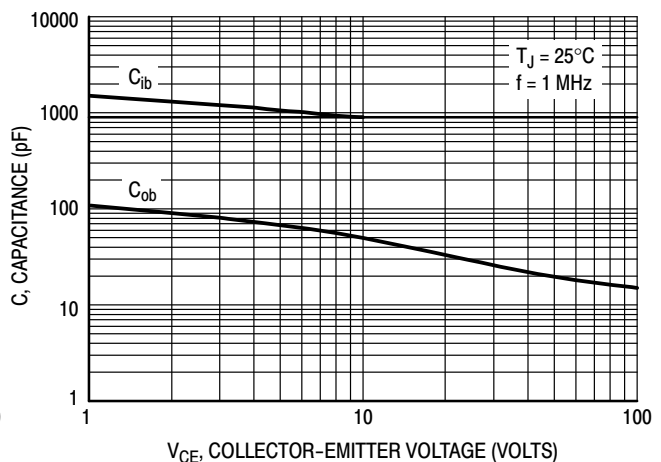

Figure 6. Capacitance

TYPICAL SWITCHING CHARACTERISTICS  
( $I_{B2} = I_C/2$  for all switching)

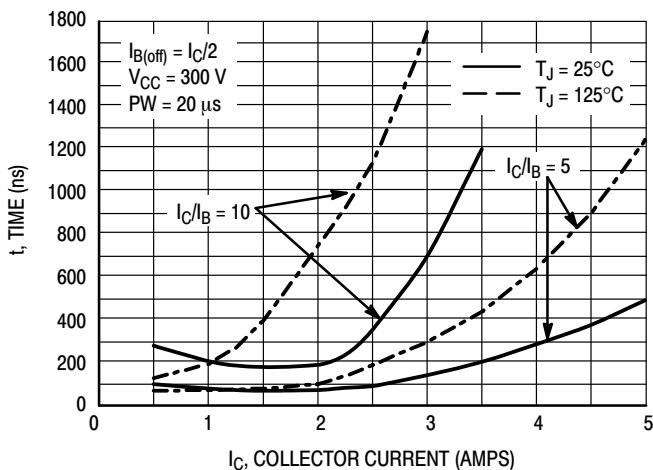

Figure 7. Resistive Switching,  $t_{on}$

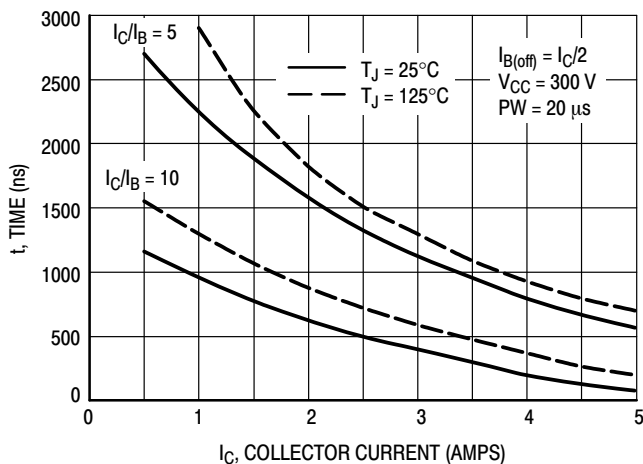

Figure 8. Resistive Switching,  $t_{off}$

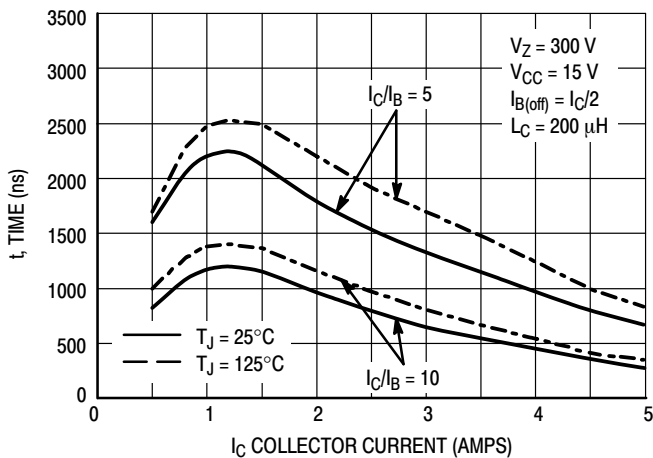

Figure 9. Inductive Storage Time,  $t_{si}$

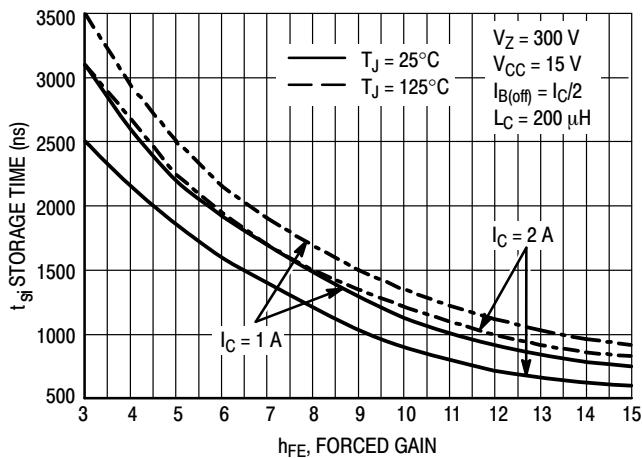

Figure 10. Inductive Storage Time,  $t_{si}(h_{FE})$

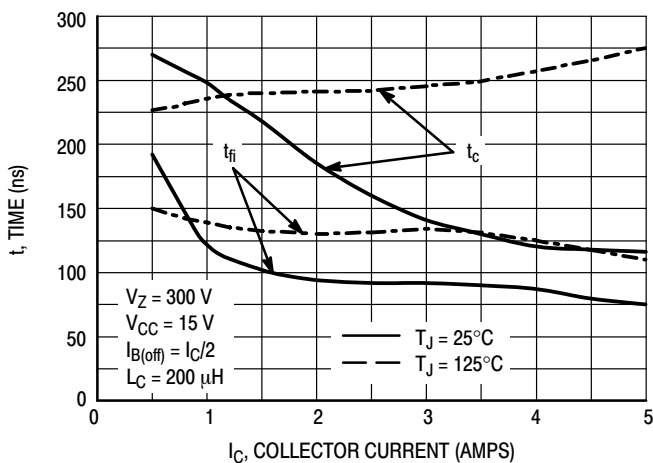

Figure 11. Inductive Switching,  $t_c$  and  $t_{fi}$ ,  $I_C/I_B = 5$

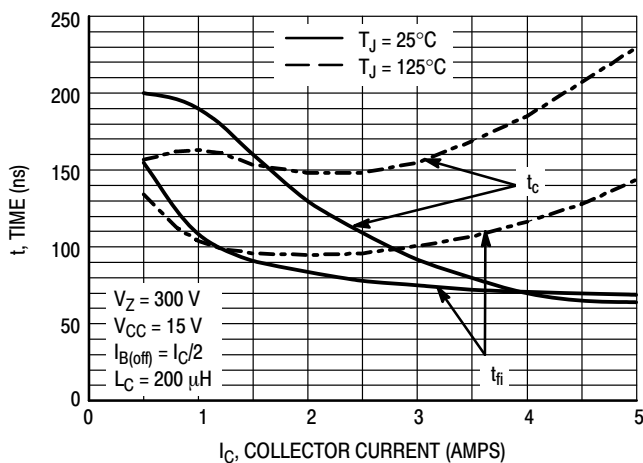

Figure 12. Inductive Switching,  $t_c$  and  $t_{fi}$ ,  $I_C/I_B = 10$

**TYPICAL SWITCHING CHARACTERISTICS**  
( $I_{B2} = I_C/2$  for all switching)

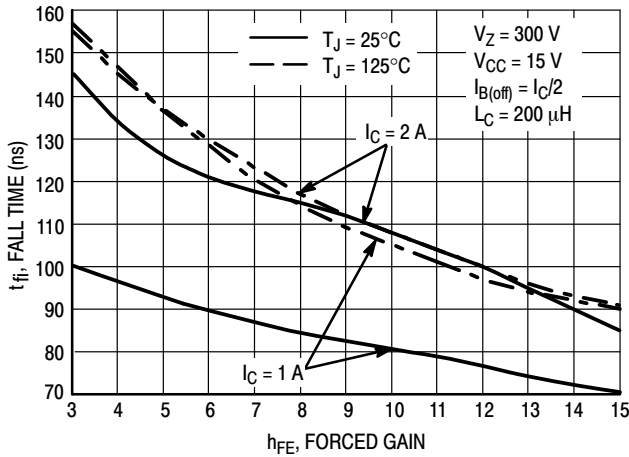

Figure 13. Inductive Fall Time

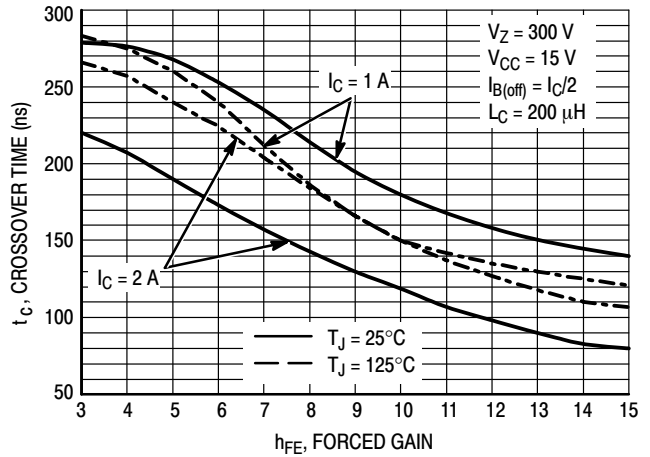

Figure 14. Inductive Crossover Time

**GUARANTEED SAFE OPERATING AREA INFORMATION**

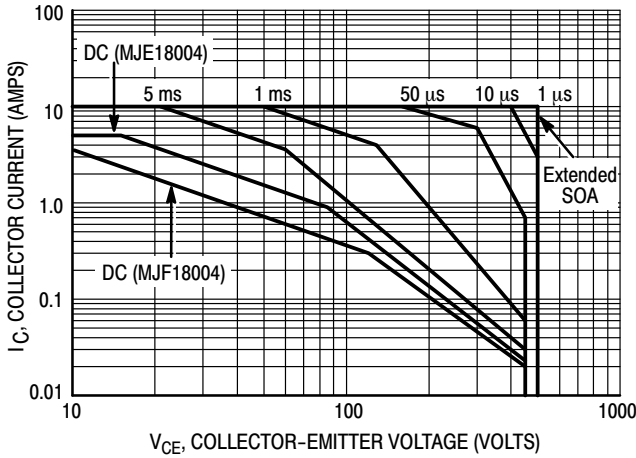

Figure 15. Forward Bias Safe Operating Area

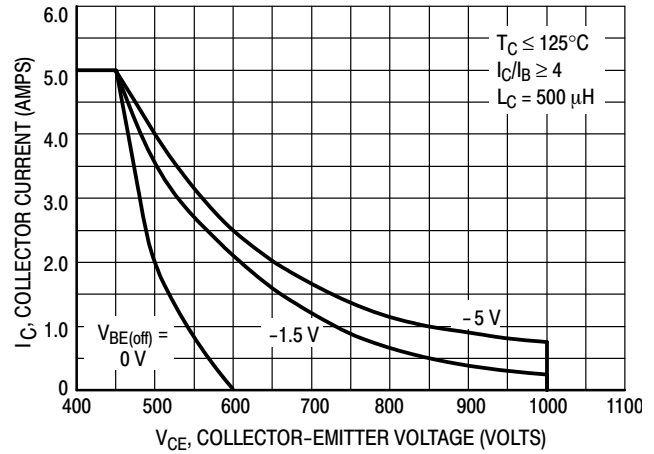

Figure 16. Reverse Bias Safe Operating Area

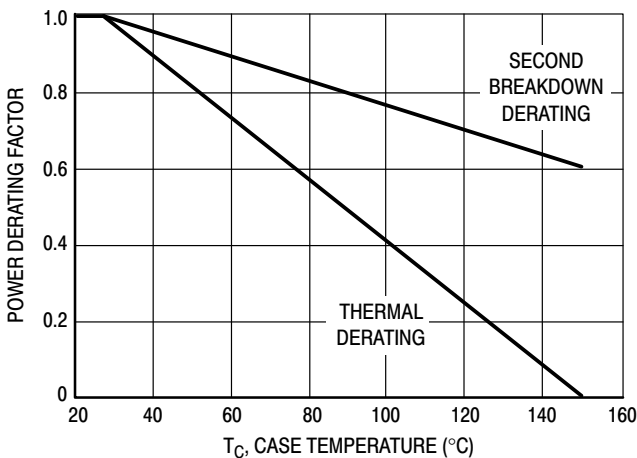

Figure 17. Forward Bias Power Derating

There are two limitations on the power handling ability of a transistor: average junction temperature and second breakdown. Safe operating area curves indicate  $I_C$ - $V_{CE}$  limits of the transistor that must be observed for reliable operation; i.e., the transistor must not be subjected to greater dissipation than the curves indicate. The data of Figure 15 is based on  $T_C = 25^\circ\text{C}$ ;  $T_J(\text{pk})$  is variable depending on power level. Second breakdown pulse limits are valid for duty cycles to 10% but must be derated when  $T_C \geq 25^\circ\text{C}$ . Second breakdown limitations do not derate the same as thermal limitations. Allowable current at the voltages shown on Figure 15 may be found at any case temperature by using the appropriate curve on Figure 17.  $T_J(\text{pk})$  may be calculated from the data in Figures 20 and 21. At any case temperatures, thermal limitations will reduce the power that can be handled to values less the limitations imposed by second breakdown. For inductive loads, high voltage and current must be sustained simultaneously during turn-off with the base-to-emitter junction reverse biased. The safe level is specified as a reverse-biased safe operating area (Figure 16). This rating is verified under clamped conditions so that the device is never subjected to an avalanche mode.

# MJE18004, MJF18004

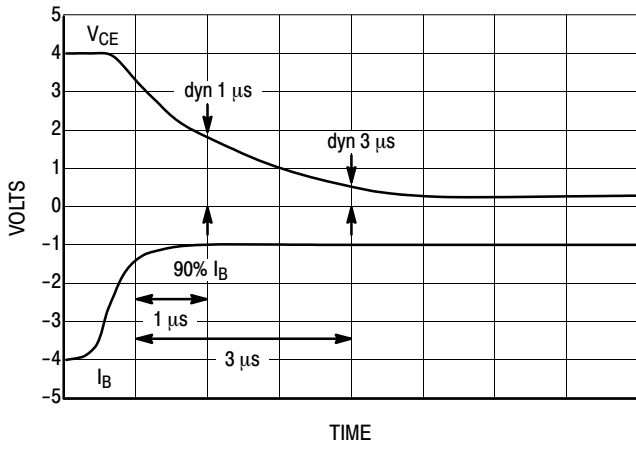

Figure 18. Dynamic Saturation Voltage Measurements

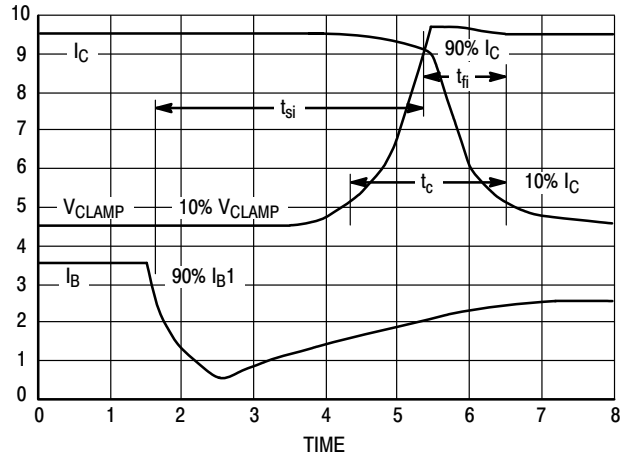
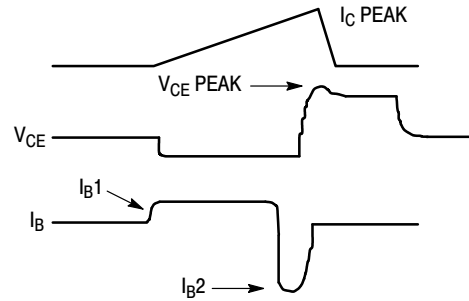
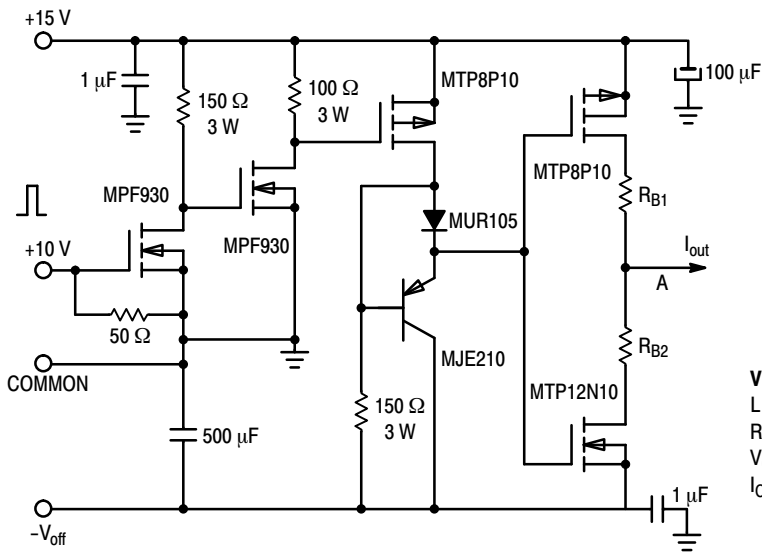

Figure 19. Inductive Switching Measurements



V(BR)CEO(sus)	INDUCTIVE SWITCHING	RBSOA
L = 10 mH	L = 200 μH	L = 500 μH
RB2 = ∞	RB2 = 0	RB2 = 0
VCC = 20 VOLTS	VCC = 15 VOLTS	VCC = 15 VOLTS
IC(pk) = 100 mA	RB1 SELECTED FOR DESIRED IB1	RB1 SELECTED FOR DESIRED IB1

Table 1. Inductive Load Switching Drive Circuit

# MJE18004, MJF18004

## TYPICAL THERMAL RESPONSE

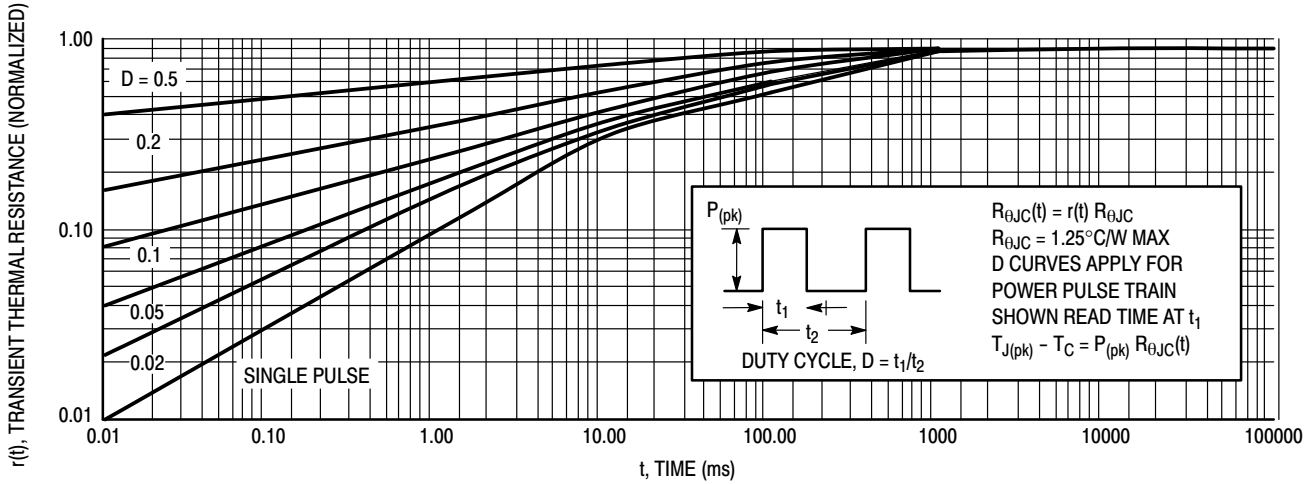

Figure 20. Typical Thermal Response ( $Z_{\theta JC}(t)$ ) for MJE18004

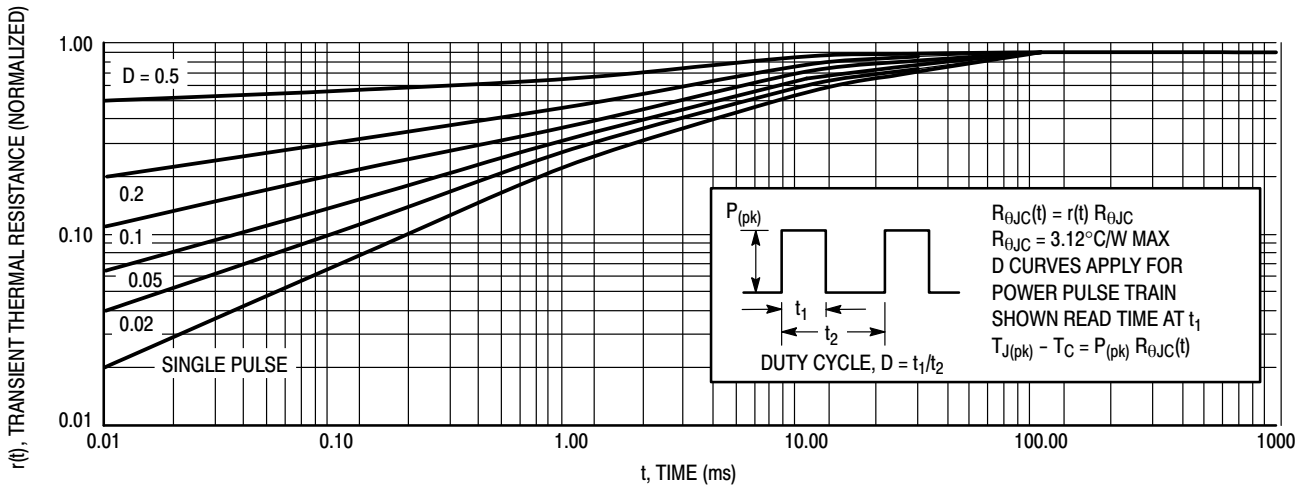

Figure 21. Typical Thermal Response for MJF18004

### ORDERING INFORMATION

Device	Package	Shipping
MJE18004G	TO-220AB (Pb-Free)	50 Units / Rail
MJF18004G	TO-220 (Fullpack) (Pb-Free)	50 Units / Rail



TEST CONDITIONS FOR ISOLATION TESTS\*

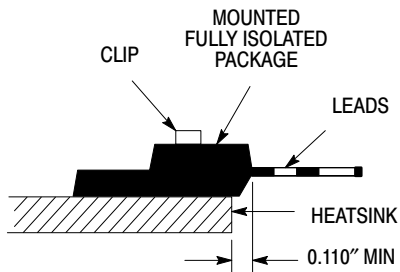

Figure 22a. Screw or Clip Mounting Position for Isolation Test Number 1

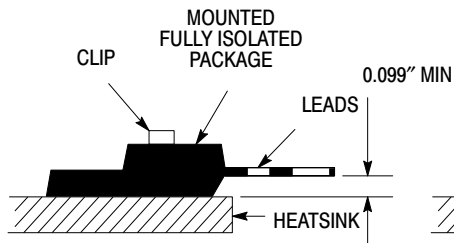

Figure 22b. Clip Mounting Position for Isolation Test Number 2

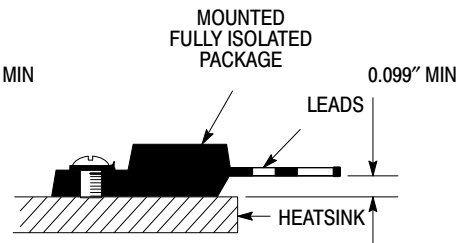

Figure 22c. Screw Mounting Position for Isolation Test Number 3

\*Measurement made between leads and heatsink with all leads shorted together

MOUNTING INFORMATION\*\*

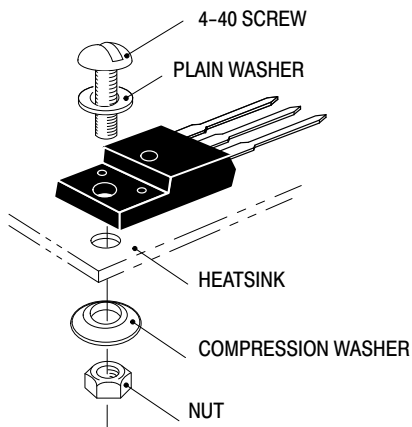

Figure 23a. Screw-Mounted

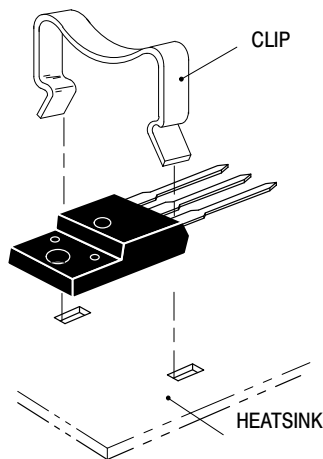

Figure 23b. Clip-Mounted

Figure 23. Typical Mounting Techniques for Isolated Package

Laboratory tests on a limited number of samples indicate, when using the screw and compression washer mounting technique, a screw torque of 6 to 8 in · lbs is sufficient to provide maximum power dissipation capability. The compression washer helps to maintain a constant pressure on the package over time and during large temperature excursions.

Destructive laboratory tests show that using a hex head 4–40 screw, without washers, and applying a torque in excess of 20 in · lbs will cause the plastic to crack around the mounting hole, resulting in a loss of isolation capability.

Additional tests on slotted 4–40 screws indicate that the screw slot fails between 15 to 20 in · lbs without adversely affecting the package. However, in order to positively ensure the package integrity of the fully isolated device, ON Semiconductor does not recommend exceeding 10 in · lbs of mounting torque under any mounting conditions.

\*\* For more information about mounting power semiconductors see Application Note AN1040.

# MECHANICAL CASE OUTLINE

## PACKAGE DIMENSIONS

ON Semiconductor®

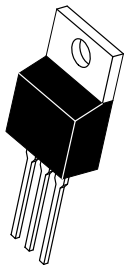

SCALE 1:1

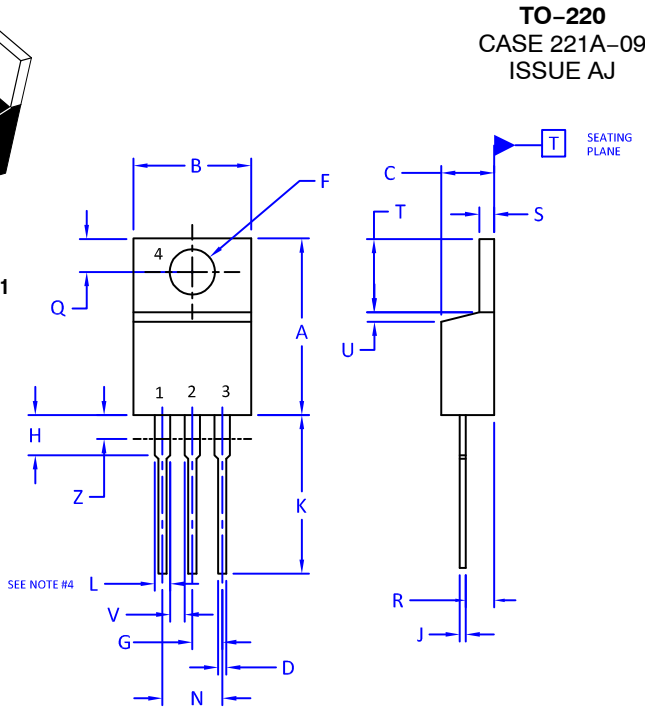

TO-220  
CASE 221A-09  
ISSUE AJ

DATE 05 NOV 2019

NOTES:

1. DIMENSIONING AND TOLERANCING PER ANSI Y14.5M, 2009.
2. CONTROLLING DIMENSION: INCHES
3. DIMENSION Z DEFINES A ZONE WHERE ALL BODY AND LEAD IRREGULARITIES ARE ALLOWED.
4. MAX WIDTH FOR F102 DEVICE = 1.35MM

DIM	INCHES		MILLIMETERS	
	MIN.	MAX.	MIN.	MAX.
A	0.570	0.620	14.48	15.75
B	0.380	0.415	9.66	10.53
C	0.160	0.190	4.07	4.83
D	0.025	0.038	0.64	0.96
F	0.142	0.161	3.60	4.09
G	0.095	0.105	2.42	2.66
H	0.110	0.161	2.80	4.10
J	0.014	0.024	0.36	0.61
K	0.500	0.562	12.70	14.27
L	0.045	0.060	1.15	1.52
N	0.190	0.210	4.83	5.33
Q	0.100	0.120	2.54	3.04
R	0.080	0.110	2.04	2.79
S	0.045	0.055	1.15	1.41
T	0.235	0.255	5.97	6.47
U	0.000	0.050	0.00	1.27
V	0.045	---	1.15	---
Z	---	0.080	---	2.04

STYLE 1:

- PIN 1. BASE
- 2. COLLECTOR
- 3. EMITTER
- 4. COLLECTOR

STYLE 2:

- PIN 1. BASE
- 2. EMITTER
- 3. COLLECTOR
- 4. EMITTER

STYLE 3:

- PIN 1. CATHODE
- 2. ANODE
- 3. GATE
- 4. ANODE

STYLE 4:

- PIN 1. MAIN TERMINAL 1
- 2. MAIN TERMINAL 2
- 3. GATE
- 4. MAIN TERMINAL 2

STYLE 5:

- PIN 1. GATE
- 2. DRAIN
- 3. SOURCE
- 4. DRAIN

STYLE 6:

- PIN 1. ANODE
- 2. CATHODE
- 3. ANODE
- 4. CATHODE

STYLE 7:

- PIN 1. CATHODE
- 2. ANODE
- 3. CATHODE
- 4. ANODE

STYLE 8:

- PIN 1. CATHODE
- 2. ANODE
- 3. EXTERNAL TRIP/DELAY
- 4. ANODE

STYLE 9:

- PIN 1. GATE
- 2. COLLECTOR
- 3. EMITTER
- 4. COLLECTOR

STYLE 10:

- PIN 1. GATE
- 2. SOURCE
- 3. DRAIN
- 4. SOURCE

STYLE 11:

- PIN 1. DRAIN
- 2. SOURCE
- 3. GATE
- 4. SOURCE

STYLE 12:

- PIN 1. MAIN TERMINAL 1
- 2. MAIN TERMINAL 2
- 3. GATE
- 4. NOT CONNECTED

DOCUMENT NUMBER:	98ASB42148B	Electronic versions are uncontrolled except when accessed directly from the Document Repository. Printed versions are uncontrolled except when stamped "CONTROLLED COPY" in red.
DESCRIPTION:	TO-220	PAGE 1 OF 1

ON Semiconductor and are trademarks of Semiconductor Components Industries, LLC dba ON Semiconductor or its subsidiaries in the United States and/or other countries. ON Semiconductor reserves the right to make changes without further notice to any products herein. ON Semiconductor makes no warranty, representation or guarantee regarding the suitability of its products for any particular purpose, nor does ON Semiconductor assume any liability arising out of the application or use of any product or circuit, and specifically disclaims any and all liability, including without limitation special, consequential or incidental damages. ON Semiconductor does not convey any license under its patent rights nor the rights of others.

# MECHANICAL CASE OUTLINE PACKAGE DIMENSIONS

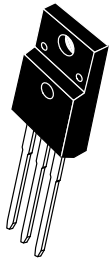

SCALE 1:1

## TO-220 FULLPAK CASE 221D-03 ISSUE K

DATE 27 FEB 2009

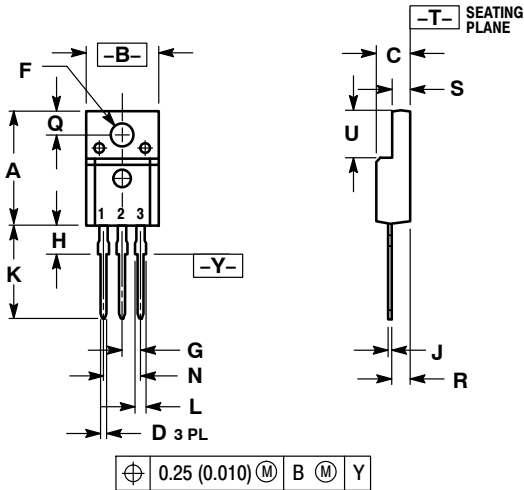

- NOTES:
- DIMENSIONING AND TOLERANCING PER ANSI Y14.5M, 1982.
  - CONTROLLING DIMENSION: INCH
  - 221D-01 THRU 221D-02 OBSOLETE, NEW STANDARD 221D-03.

DIM	INCHES		MILLIMETERS	
	MIN	MAX	MIN	MAX
A	0.617	0.635	15.67	16.12
B	0.392	0.419	9.96	10.63
C	0.177	0.193	4.50	4.90
D	0.024	0.039	0.60	1.00
F	0.116	0.129	2.95	3.28
G	0.100 BSC		2.54 BSC	
H	0.118	0.135	3.00	3.43
J	0.018	0.025	0.45	0.63
K	0.503	0.541	12.78	13.73
L	0.048	0.058	1.23	1.47
N	0.200 BSC		5.08 BSC	
Q	0.122	0.138	3.10	3.50
R	0.099	0.117	2.51	2.96
S	0.092	0.113	2.34	2.87
U	0.239	0.271	6.06	6.88

### MARKING DIAGRAMS

- |  |   |  |
|--|---|--|
| STYLE 1:<br>PIN 1. GATE<br>2. DRAIN<br>3. SOURCE     | STYLE 2:<br>PIN 1. BASE<br>2. COLLECTOR<br>3. EMITTER | STYLE 3:<br>PIN 1. ANODE<br>2. CATHODE<br>3. ANODE |
| STYLE 4:<br>PIN 1. CATHODE<br>2. ANODE<br>3. CATHODE | STYLE 5:<br>PIN 1. CATHODE<br>2. ANODE<br>3. GATE     | STYLE 6:<br>PIN 1. MT 1<br>2. MT 2<br>3. GATE      |



**Bipolar**

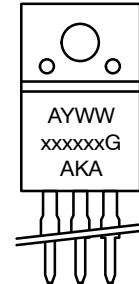

**Rectifier**

- |                               |                           |
|-------------------------------|---------------------------|
| xxxxxx = Specific Device Code | A = Assembly Location     |
| G = Pb-Free Package           | Y = Year                  |
| A = Assembly Location         | WW = Work Week            |
| Y = Year                      | xxxxxx = Device Code      |
| WW = Work Week                | G = Pb-Free Package       |
|                               | AKA = Polarity Designator |

<b>DOCUMENT NUMBER:</b> 98ASB42514B	Electronic versions are uncontrolled except when accessed directly from the Document Repository. Printed versions are uncontrolled except when stamped "CONTROLLED COPY" in red.
<b>DESCRIPTION:</b> TO-220 FULLPAK	<b>PAGE 1 OF 1</b>

ON Semiconductor and are trademarks of Semiconductor Components Industries, LLC dba ON Semiconductor or its subsidiaries in the United States and/or other countries. ON Semiconductor reserves the right to make changes without further notice to any products herein. ON Semiconductor makes no warranty, representation or guarantee regarding the suitability of its products for any particular purpose, nor does ON Semiconductor assume any liability arising out of the application or use of any product or circuit, and specifically disclaims any and all liability, including without limitation special, consequential or incidental damages. ON Semiconductor does not convey any license under its patent rights nor the rights of others.

**onsemi**, **Onsemi**, and other names, marks, and brands are registered and/or common law trademarks of Semiconductor Components Industries, LLC dba "**onsemi**" or its affiliates and/or subsidiaries in the United States and/or other countries. **onsemi** owns the rights to a number of patents, trademarks, copyrights, trade secrets, and other intellectual property. A listing of **onsemi**'s product/patent coverage may be accessed at [www.onsemi.com/site/pdf/Patent-Marking.pdf](http://www.onsemi.com/site/pdf/Patent-Marking.pdf). **onsemi** reserves the right to make changes at any time to any products or information herein, without notice. The information herein is provided "as-is" and **onsemi** makes no warranty, representation or guarantee regarding the accuracy of the information, product features, availability, functionality, or suitability of its products for any particular purpose, nor does **onsemi** assume any liability arising out of the application or use of any product or circuit, and specifically disclaims any and all liability, including without limitation special, consequential or incidental damages. Buyer is responsible for its products and applications using **onsemi** products, including compliance with all laws, regulations and safety requirements or standards, regardless of any support or applications information provided by **onsemi**. "Typical" parameters which may be provided in **onsemi** data sheets and/or specifications can and do vary in different applications and actual performance may vary over time. All operating parameters, including "Typicals" must be validated for each customer application by customer's technical experts. **onsemi** does not convey any license under any of its intellectual property rights nor the rights of others. **onsemi** products are not designed, intended, or authorized for use as a critical component in life support systems or any FDA Class 3 medical devices or medical devices with a same or similar classification in a foreign jurisdiction or any devices intended for implantation in the human body. Should Buyer purchase or use **onsemi** products for any such unintended or unauthorized application, Buyer shall indemnify and hold **onsemi** and its officers, employees, subsidiaries, affiliates, and distributors harmless against all claims, costs, damages, and expenses, and reasonable attorney fees arising out of, directly or indirectly, any claim of personal injury or death associated with such unintended or unauthorized use, even if such claim alleges that **onsemi** was negligent regarding the design or manufacture of the part. **onsemi** is an Equal Opportunity/Affirmative Action Employer. This literature is subject to all applicable copyright laws and is not for resale in any manner.

## PUBLICATION ORDERING INFORMATION

### LITERATURE FULFILLMENT:

Email Requests to: [orderlit@onsemi.com](mailto:orderlit@onsemi.com)

**onsemi Website:** [www.onsemi.com](http://www.onsemi.com)

### TECHNICAL SUPPORT

**North American Technical Support:**

Voice Mail: 1 800-282-9855 Toll Free USA/Canada

Phone: 011 421 33 790 2910

**Europe, Middle East and Africa Technical Support:**

Phone: 00421 33 790 2910

For additional information, please contact your local Sales Representative

# Mouser Electronics

Authorized Distributor

Click to View Pricing, Inventory, Delivery & Lifecycle Information:

[onsemi:](#)

[MJE18004](#) [MJE18004G](#) [MJF18004](#) [MJF18004G](#)