

# NPN General - Purpose Amplifier

## 2N3904

### Description

This device is designed as a general-purpose amplifier and switch. The useful dynamic range extends to 100 mA as a switch and to 100 MHz as an amplifier.

### MAXIMUM RATINGS

(Values are at  $T_A = 25^\circ\text{C}$  unless otherwise noted.) (Note 1, Note 2)

Symbol	Parameter	Value	Unit
$V_{CEO}$	Collector - Emitter Voltage	40	V
$V_{CBO}$	Collector - Base Voltage	60	V
$V_{EBO}$	Emitter - Base Voltage	6.0	V
$I_C$	Collector Current - Continuous	200	mA
$T_J, T_{STG}$	Operating and Storage Junction Temperature Range	-55 to +150	$^\circ\text{C}$

Stresses exceeding those listed in the Maximum Ratings table may damage the device. If any of these limits are exceeded, device functionality should not be assumed, damage may occur and reliability may be affected.

1. These ratings are based on a maximum junction temperature of  $150^\circ\text{C}$ .
2. These are steady-state limits. ON Semiconductor should be consulted on applications involving pulsed or low-duty cycle operations.

### THERMAL CHARACTERISTICS

(Values are at  $T_A = 25^\circ\text{C}$  unless otherwise noted.)

Symbol	Parameter	Max	Unit
$P_D$	Total Device Dissipation	625	mW
	Derate Above $25^\circ\text{C}$	5.0	mW/ $^\circ\text{C}$
$R_{\theta JC}$	Thermal Resistance, Junction to Case	83.3	$^\circ\text{C}/\text{W}$
$R_{\theta JA}$	Thermal Resistance, Junction to Ambient	200	$^\circ\text{C}/\text{W}$



ON Semiconductor®

[www.onsemi.com](http://www.onsemi.com)



TO-92 3  
CASE 135AN



TO-92 3  
LEADFORMED  
CASE 135AR

### MARKING DIAGRAM

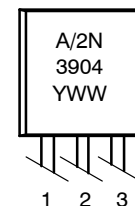

- 1: Emitter
- 2: Base
- 3: Collector

A = Assembly Code  
2N3904 = Device Code  
YWW = Date Code

### ORDERING INFORMATION

See detailed ordering and shipping information in the package dimensions section on page 6 of this data sheet.

## 2N3904

### ELECTRICAL CHARACTERISTICS (Values are at $T_A = 25^\circ\text{C}$ unless otherwise noted.)

Symbol	Parametr	Conditions	Min	Max	Unit
<b>OFF CHARACTERISTICS</b>					
$V_{(BR)CEO}$	Collector – Emitter Breakdown Voltage	$I_C = 1.0 \text{ mA}, I_B = 0$	40	–	V
$V_{(BR)CBO}$	Collector – Base Breakdown Voltage	$I_C = 10 \mu\text{A}, I_E = 0$	60	–	V
$V_{(BR)EBO}$	Emitter – Base Breakdown Voltage	$I_E = 10 \mu\text{A}, I_C = 0$	6.0	–	V
$I_{BL}$	Base Cutoff Current	$V_{CE} = 30 \text{ V}, V_{EB} = 3 \text{ V}$	–	50	nA
$I_{CEX}$	Collector Cut-Off Current	$V_{CE} = 30 \text{ V}, V_{EB} = 3 \text{ V}$	–	50	nA

### ON CHARACTERISTICS (Note 3)

$h_{FE}$	DC Current Gain	$I_C = 0.1 \text{ mA}, V_{CE} = 1.0 \text{ V}$	40	–	–
		$I_C = 1.0 \text{ mA}, V_{CE} = 1.0 \text{ V}$	70	–	
		$I_C = 10 \text{ mA}, V_{CE} = 1.0 \text{ V}$	100	300	
		$I_C = 50 \text{ mA}, V_{CE} = 1.0 \text{ V}$	60	–	
		$I_C = 100 \text{ mA}, V_{CE} = 1.0 \text{ V}$	30	–	
$V_{CE(sat)}$	Collector – Emitter Saturation Voltage	$I_C = 10 \text{ mA}, I_B = 1.0 \text{ mA}$	–	0.2	V
		$I_C = 50.0 \text{ mA}, I_B = 5.0 \text{ mA}$	–	0.3	
$V_{BE(sat)}$	Base – Emitter Saturation Voltage	$I_C = 10.0 \text{ mA}, I_B = 1.0 \text{ mA}$	0.65	0.85	V
		$I_C = 50.0 \text{ mA}, I_B = 5.0 \text{ mA}$	–	0.95	

### SMALL-SIGNAL CHARACTERISTICS

$f_T$	Current – Gain – Bandwidth Product	$I_C = 10 \text{ mA}, V_{CE} = 20 \text{ V}, f = 100 \text{ MHz}$	300	–	MHz
$C_{obo}$	Output Capacitance	$V_{CB} = 5.0 \text{ V}, I_E = 0, f = 100 \text{ kHz}$	–	4.0	pF
$C_{ibo}$	Input Capacitance	$V_{EB} = 0.5 \text{ V}, I_C = 0, f = 100 \text{ kHz}$	–	8.0	pF
NF	Noise Figure	$I_C = 100 \mu\text{A}, V_{CE} = 5.0 \text{ V}, R_S = 1.0 \text{ k}\Omega, f = 10 \text{ Hz to } 15.7 \text{ kHz}$	–	5.0	dB

### SWITCHING CHARACTERISTICS

$t_d$	Delay Time	$V_{CC} = 3.0 \text{ V}, V_{BE} = 0.5 \text{ V}, I_C = 10 \text{ mA}, I_{B1} = 1.0 \text{ mA}$	–	35	ns
$t_r$	Rise Time		–	35	ns
$t_s$	Storage Time	$V_{CC} = 3.0 \text{ V}, I_C = 10 \text{ mA}, I_{B1} = I_{B2} = 1.0 \text{ mA}$	–	200	ns
$t_f$	Fall Time		–	50	ns

Product parametric performance is indicated in the Electrical Characteristics for the listed test conditions, unless otherwise noted. Product performance may not be indicated by the Electrical Characteristics if operated under different conditions.

3. Pulse Test: Pulse Width  $\leq 300 \mu\text{s}$ ; Duty Cycle  $\leq 2\%$ .

TYPICAL PERFORMANCE CHARACTERISTICS

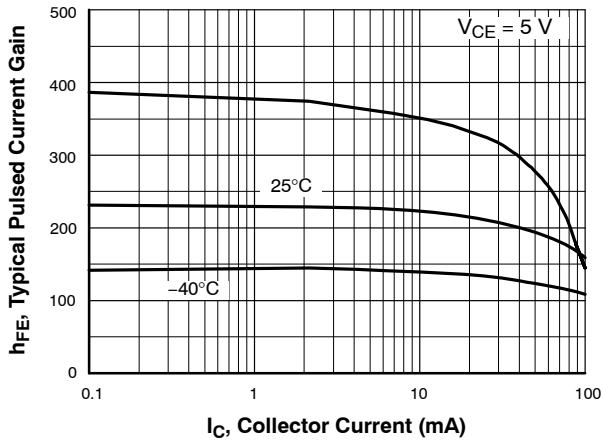

Figure 1. Typical Pulsed Current Gain vs. Collector Current

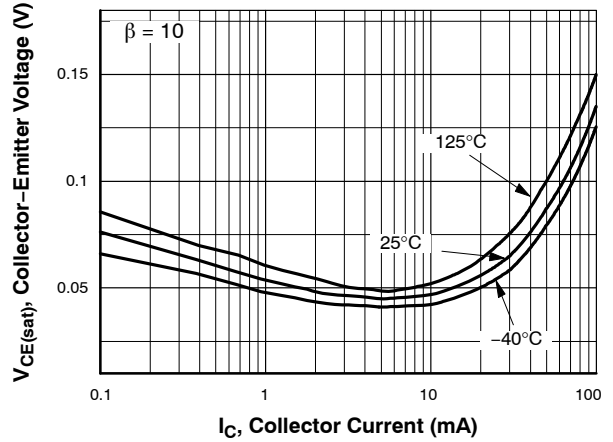

Figure 2. Collector-Emitter Saturation Voltage vs. Collector Current

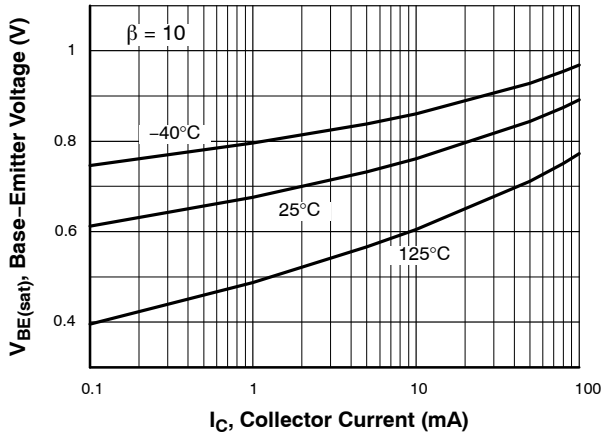

Figure 3. Base-Emitter Saturation Voltage vs. Collector Current

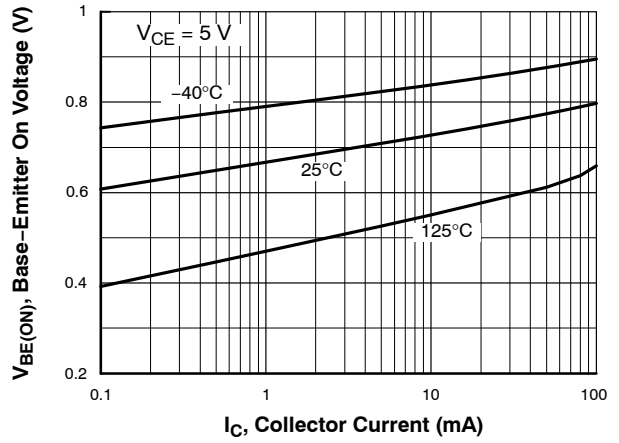

Figure 4. Base-Emitter On Voltage vs. Collector Current

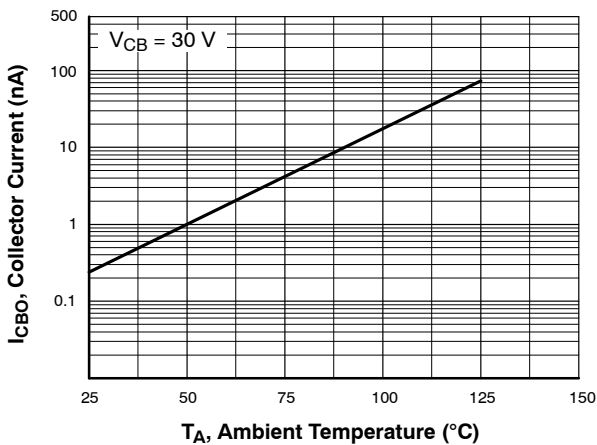

Figure 5. Collector Cut-Off Current vs. Ambient Temperature

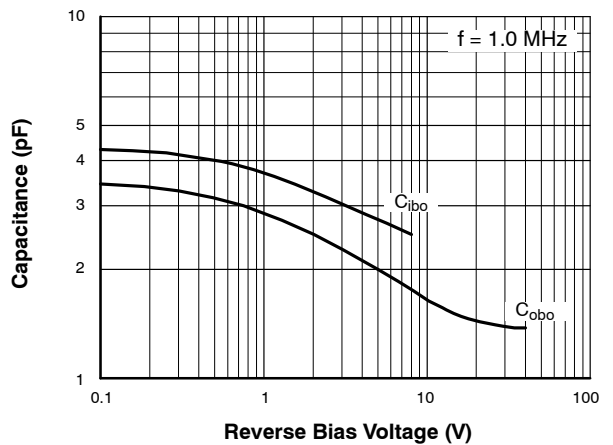

Figure 6. Capacitance vs. Reverse Bias Voltage

TYPICAL PERFORMANCE CHARACTERISTICS (Continued)

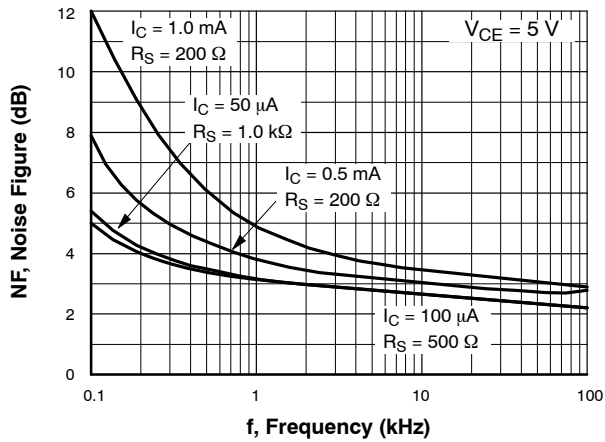

Figure 7. Noise Figure vs. Frequency

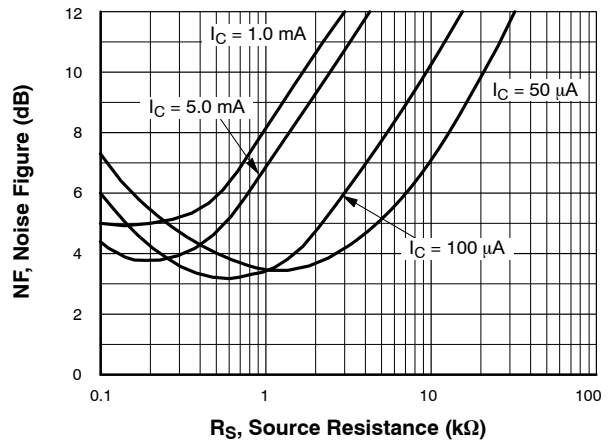

Figure 8. Noise Figure vs. Source Resistance

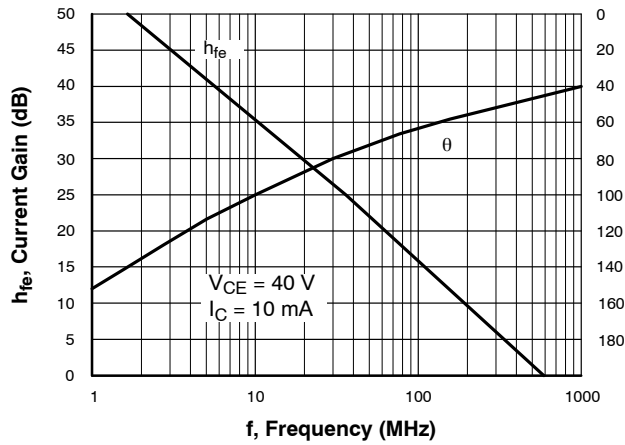

Figure 9. Current Gain and Phase Angle vs. Frequency

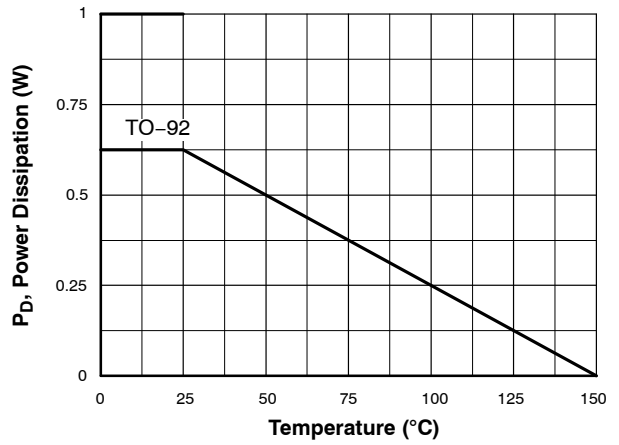

Figure 10. Power Dissipation vs. Ambient Temperature

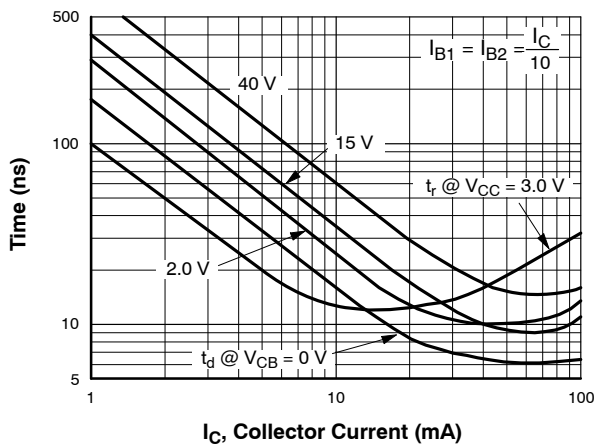

Figure 11. Turn-On Time vs. Collector Current

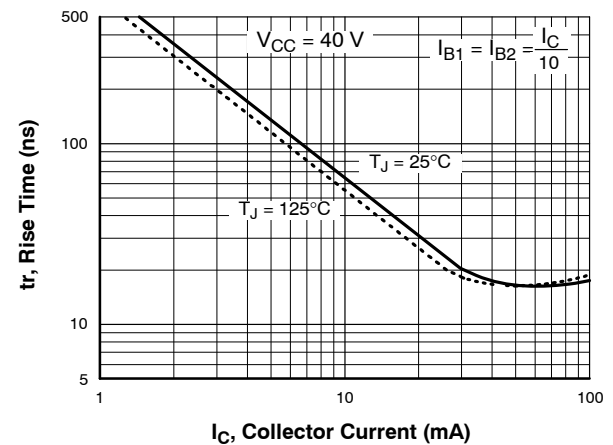

Figure 12. Rise Time vs. Collector Current

TYPICAL PERFORMANCE CHARACTERISTICS (Continued)

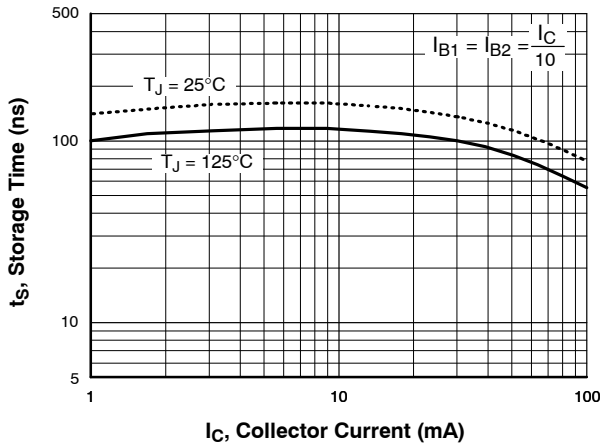

Figure 13. Storage Time vs. Collector Current

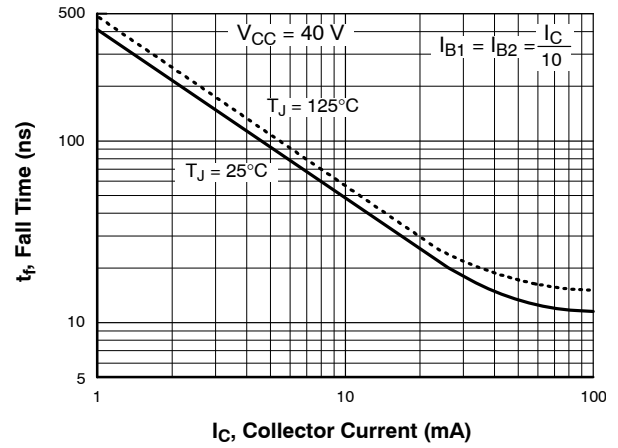

Figure 14. Fall Time vs. Collector Current

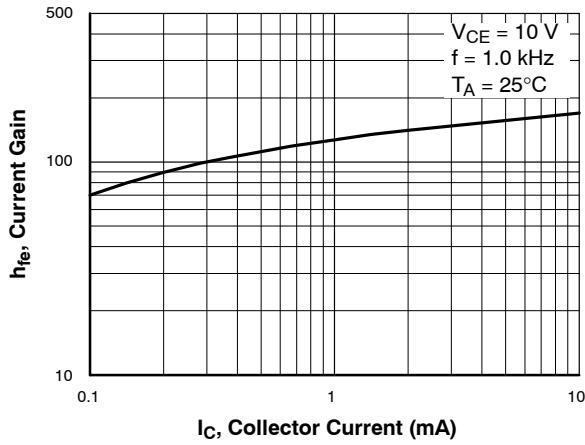

Figure 15. Current Gain

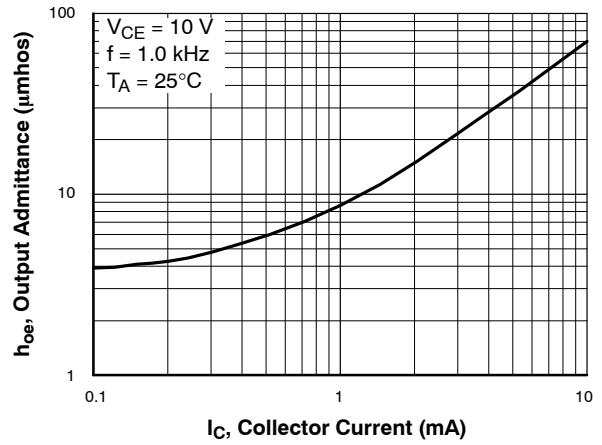

Figure 16. Output Admittance

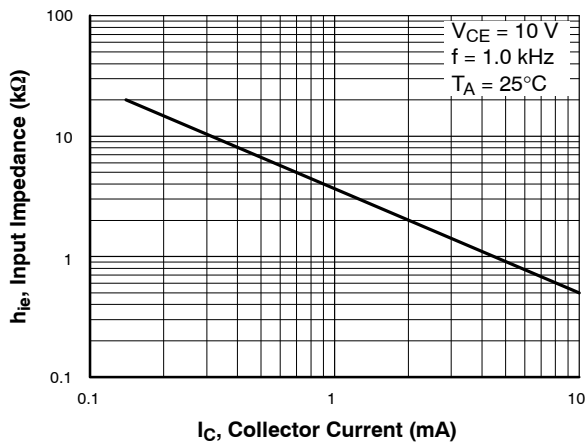

Figure 17. Input Impedance

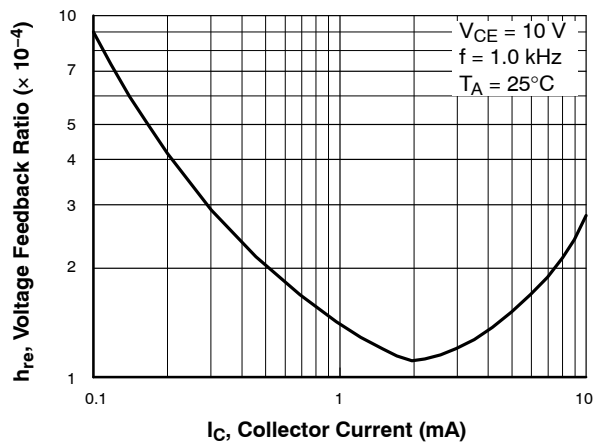

Figure 18. Voltage Feedback Ratio

# 2N3904

## TEST CIRCUITS

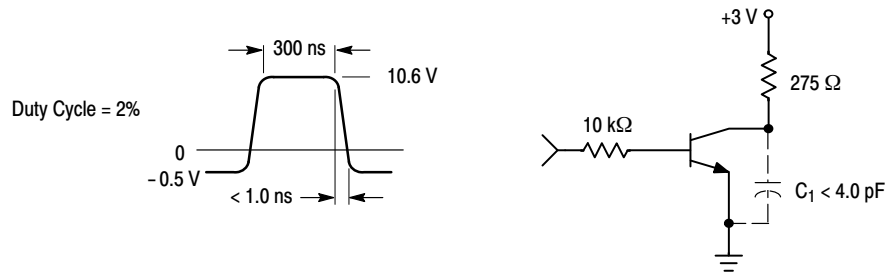

Figure 19. Delay and Rise Time Equivalent Test Circuit

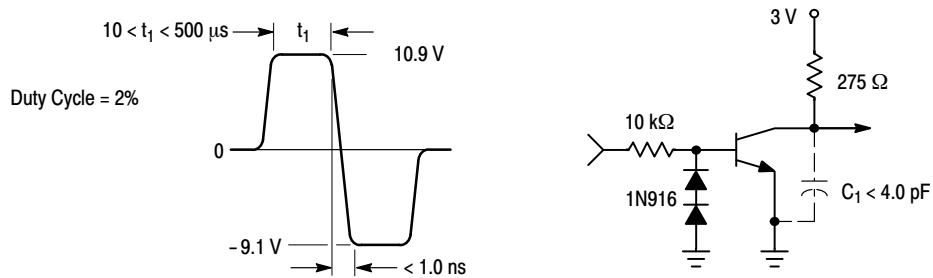

Figure 20. Storage and Fall Time Equivalent Test Circuit

### ORDERING INFORMATION

Device	Package	Shipping <sup>†</sup>
2N3904BU	TO-92-3 LF (Pb-Free)	10000 Units / Bulk Bag
2N3904TA	TO-92-3 LF (Pb-Free)	2000 Units / Fan-Fold
2N3904TAR	TO-92-3 LF (Pb-Free)	2000 Units / Fan-Fold
2N3904TF	TO-92-3 LF (Pb-Free)	2000 Units / Tape & Reel
2N3904TFR	TO-92-3 LF (Pb-Free)	2000 Units / Tape & Reel

<sup>†</sup>For information on tape and reel specifications, including part orientation and tape sizes, please refer to our Tape and Reel Packaging Specifications Brochure, BRD8011/D.

**MECHANICAL CASE OUTLINE**  
**PACKAGE DIMENSIONS**

TO-92 3 4.825x4.76  
CASE 135AN  
ISSUE O

DATE 31 JUL 2016

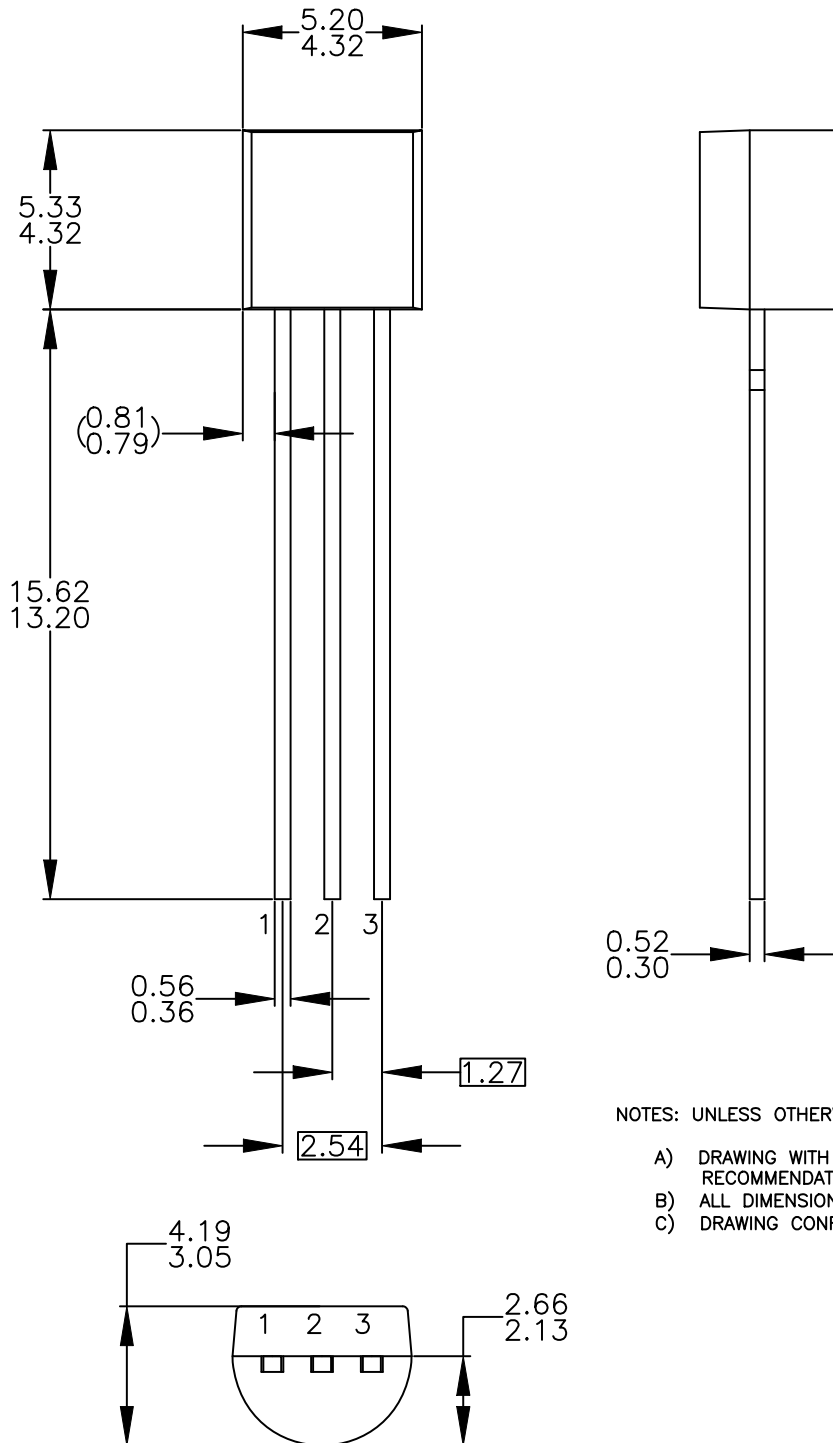

NOTES: UNLESS OTHERWISE SPECIFIED

- A) DRAWING WITH REFERENCE TO JEDEC TO-92 RECOMMENDATIONS.
- B) ALL DIMENSIONS ARE IN MILLIMETERS.
- C) DRAWING CONFORMS TO ASME Y14.5M-2009.

<b>DOCUMENT NUMBER:</b>	<b>98AON13880G</b>	Electronic versions are uncontrolled except when accessed directly from the Document Repository. Printed versions are uncontrolled except when stamped "CONTROLLED COPY" in red.
<b>DESCRIPTION:</b>	<b>TO-92 3 4.825X4.76</b>	<b>PAGE 1 OF 1</b>

ON Semiconductor and **ON** are trademarks of Semiconductor Components Industries, LLC dba ON Semiconductor or its subsidiaries in the United States and/or other countries. ON Semiconductor reserves the right to make changes without further notice to any products herein. ON Semiconductor makes no warranty, representation or guarantee regarding the suitability of its products for any particular purpose, nor does ON Semiconductor assume any liability arising out of the application or use of any product or circuit, and specifically disclaims any and all liability, including without limitation special, consequential or incidental damages. ON Semiconductor does not convey any license under its patent rights nor the rights of others.

**TO-92 3 4.83x4.76 LEADFORMED**  
**CASE 135AR**  
**ISSUE O**

DATE 30 SEP 2016



NOTES: UNLESS OTHERWISE SPECIFIED

- A) DRAWING WITH REFERENCE TO JEDEC TO-92 RECOMMENDATIONS.
- B) ALL DIMENSIONS ARE IN MILLIMETERS.
- C) DRAWING CONFORMS TO ASME Y14.5M-1994

<b>DOCUMENT NUMBER:</b>	<b>98AON13879G</b>	Electronic versions are uncontrolled except when accessed directly from the Document Repository. Printed versions are uncontrolled except when stamped "CONTROLLED COPY" in red.
<b>DESCRIPTION:</b>	<b>TO-92 3 4.83X4.76 LEADFORMED</b>	<b>PAGE 1 OF 1</b>

ON Semiconductor and **ON** are trademarks of Semiconductor Components Industries, LLC dba ON Semiconductor or its subsidiaries in the United States and/or other countries. ON Semiconductor reserves the right to make changes without further notice to any products herein. ON Semiconductor makes no warranty, representation or guarantee regarding the suitability of its products for any particular purpose, nor does ON Semiconductor assume any liability arising out of the application or use of any product or circuit, and specifically disclaims any and all liability, including without limitation special, consequential or incidental damages. ON Semiconductor does not convey any license under its patent rights nor the rights of others.



**onsemi**, **Onsemi**, and other names, marks, and brands are registered and/or common law trademarks of Semiconductor Components Industries, LLC dba "**onsemi**" or its affiliates and/or subsidiaries in the United States and/or other countries. **onsemi** owns the rights to a number of patents, trademarks, copyrights, trade secrets, and other intellectual property. A listing of **onsemi**'s product/patent coverage may be accessed at [www.onsemi.com/site/pdf/Patent-Marking.pdf](http://www.onsemi.com/site/pdf/Patent-Marking.pdf). **onsemi** reserves the right to make changes at any time to any products or information herein, without notice. The information herein is provided "as-is" and **onsemi** makes no warranty, representation or guarantee regarding the accuracy of the information, product features, availability, functionality, or suitability of its products for any particular purpose, nor does **onsemi** assume any liability arising out of the application or use of any product or circuit, and specifically disclaims any and all liability, including without limitation special, consequential or incidental damages. Buyer is responsible for its products and applications using **onsemi** products, including compliance with all laws, regulations and safety requirements or standards, regardless of any support or applications information provided by **onsemi**. "Typical" parameters which may be provided in **onsemi** data sheets and/or specifications can and do vary in different applications and actual performance may vary over time. All operating parameters, including "Typicals" must be validated for each customer application by customer's technical experts. **onsemi** does not convey any license under any of its intellectual property rights nor the rights of others. **onsemi** products are not designed, intended, or authorized for use as a critical component in life support systems or any FDA Class 3 medical devices or medical devices with a same or similar classification in a foreign jurisdiction or any devices intended for implantation in the human body. Should Buyer purchase or use **onsemi** products for any such unintended or unauthorized application, Buyer shall indemnify and hold **onsemi** and its officers, employees, subsidiaries, affiliates, and distributors harmless against all claims, costs, damages, and expenses, and reasonable attorney fees arising out of, directly or indirectly, any claim of personal injury or death associated with such unintended or unauthorized use, even if such claim alleges that **onsemi** was negligent regarding the design or manufacture of the part. **onsemi** is an Equal Opportunity/Affirmative Action Employer. This literature is subject to all applicable copyright laws and is not for resale in any manner.

## PUBLICATION ORDERING INFORMATION

### LITERATURE FULFILLMENT:

Email Requests to: [orderlit@onsemi.com](mailto:orderlit@onsemi.com)

**onsemi** Website: [www.onsemi.com](http://www.onsemi.com)

### TECHNICAL SUPPORT

**North American Technical Support:**

Voice Mail: 1 800-282-9855 Toll Free USA/Canada

Phone: 011 421 33 790 2910

**Europe, Middle East and Africa Technical Support:**

Phone: 00421 33 790 2910

For additional information, please contact your local Sales Representative