

3.1V_{IN} to 31V_{IN} Isolated μ Module DC/DC Converter with LDO Post Regulator

FEATURES

- 2kV AC Isolated μ Module Converter (Tested to 3kVDC)
- UL60950 Recognized File E464570 c us
- Wide Input Voltage Range: 3.1V to 31V
- V_{OUT1} Output:
 - Up to 440mA (V_{IN} = 24V, V_{OUT1} = 2.5V)
 - 2.5V to 13V Output Range
- V_{OUT2} Low Noise Linear Post Regulator:
 - Up to 300mA
 - 1.2V to 12V Output Range
- Current Mode Control
- Programmable Soft-Start
- User Configurable Undervoltage Lockout
- Low Profile (9mm × 11.25mm × 4.92mm) BGA Package

APPLICATIONS

- Industrial Sensors
- Industrial Switches
- Ground Loop Mitigation

DESCRIPTION

The LTM[®]8058 is a 2kV AC isolated flyback μ Module[®] (micromodule) DC/DC converter with LDO post regulator. Included in the package are the switching controller, power switches, transformer, LDO, and all support components. Operating over an input voltage range of 3.1V to 31V, the LTM8058 supports an output voltage range of 2.5V to 13V, set by a single resistor. There is also a linear post regulator whose output voltage is adjustable from 1.2V to 12V as set by a single resistor. Only output and input capacitors are needed to finish the design. Other components may be used to control the soft-start control and biasing.

The LTM8058 is packaged in a thermally enhanced, compact (9mm × 11.25mm × 4.92mm) overmolded ball grid array (BGA) package suitable for automated assembly by standard surface mount equipment. The LTM8058 is available with SnPb or RoHS compliant terminal finish.

LT, LT, LTC, LTM, Linear Technology, the Linear logo and μ Module are registered trademarks of Analog Devices, Inc. All other trademarks are the property of their respective owners.

TYPICAL APPLICATION

2kV AC Isolated Low Noise μ Module Regulator

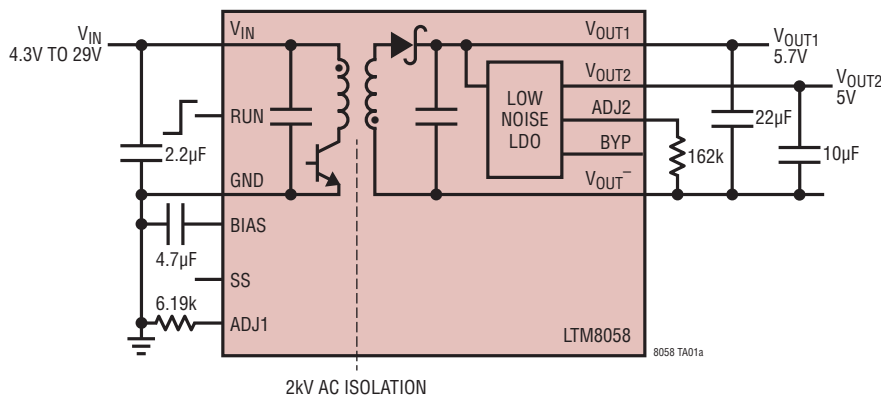

Total Output Current vs V_{IN}

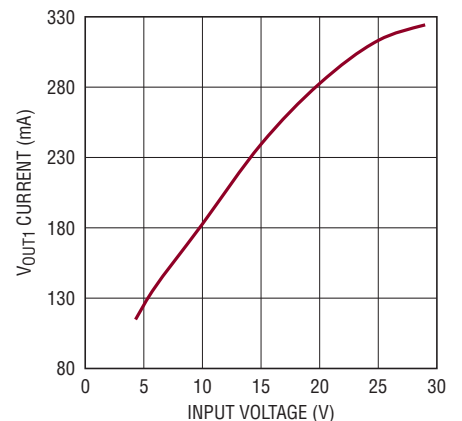

LTM8058

ABSOLUTE MAXIMUM RATINGS

(Note 1)

V_{IN} , RUN	32V
BIAS	V_{IN}
ADJ1, SS	5V
V_{OUT1} Relative to V_{OUT}^-	+16V
$V_{IN} + V_{OUT1}$ (Note 2)	36V
V_{OUT2} Relative to V_{OUT}^-	+20V
ADJ2 Relative to V_{OUT}^-	+7V
GND to V_{OUT}^- Isolation (Note 3)	2kV AC
Maximum Internal Temperature (Note 4)	125°C
Maximum Peak Body Reflow Temperature	245°C
Storage Temperature	-55°C to 125°C

PIN CONFIGURATION

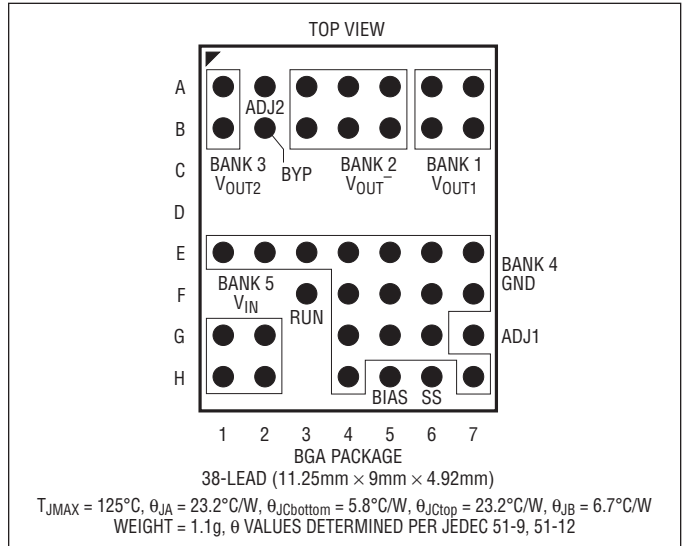

ORDER INFORMATION <http://www.linear.com/product/LTM8058#orderinfo>

PART NUMBER	PAD OR BALL FINISH	PART MARKING*		PACKAGE TYPE	MSL RATING	TEMPERATURE RANGE (Note 4)
		DEVICE	FINISH CODE			
LTM8058EY#PBF	SAC305 (RoHS)	LTM8058Y	e1	BGA	3	-40°C to 125°C
LTM8058IY#PBF	SAC305 (RoHS)	LTM8058Y	e1	BGA	3	-40°C to 125°C
LTM8058IY	SnPb (63/37)	LTM8058Y	e0	BGA	3	-40°C to 125°C
LTM8058MPY#PBF	SAC305 (RoHS)	LTM8058Y	e1	BGA	3	-55°C to 125°C
LTM8058MPY	SnPb (63/37)	LTM8058Y	e0	BGA	3	-55°C to 125°C

Consult Marketing for parts specified with wider operating temperature ranges. *Device temperature grade is indicated by a label on the shipping container. Pad or ball finish code is per IPC/JEDEC J-STD-609.

- Terminal Finish Part Marking: www.linear.com/leadfree

- Recommended LGA and BGA PCB Assembly and Manufacturing Procedures: www.linear.com/umodule/pcbassembly
- LGA and BGA Package and Tray Drawings: www.linear.com/packaging

ELECTRICAL CHARACTERISTICS

The ● denotes the specifications which apply over the full internal operating temperature range, otherwise specifications are at $T_A = 25^\circ\text{C}$, $\text{RUN} = 12\text{V}$ (Note 4).

PARAMETER	CONDITIONS	MIN	TYP	MAX	UNITS
Minimum Input DC Voltage	BIAS = V_{IN} , $\text{RUN} = 2\text{V}$ BIAS Open, $\text{RUN} = 2\text{V}$	●		3.1	V
				4.3	V
V_{OUT1} DC Voltage	$R_{\text{ADJ1}} = 12.4\text{k}$ $R_{\text{ADJ1}} = 6.98\text{k}$ $R_{\text{ADJ1}} = 3.16\text{k}$	●	4.75	2.5	V
				5	V
				12	V
V_{IN} Quiescent Current	$V_{\text{RUN}} = 0\text{V}$ Not Switching		850	1	μA μA
V_{OUT1} Line Regulation	$6\text{V} \leq V_{\text{IN}} \leq 31\text{V}$, $I_{\text{OUT}} = 0.15\text{A}$, $\text{RUN} = 2\text{V}$		1.7		%
V_{OUT1} Load Regulation	$0.05\text{A} \leq I_{\text{OUT}} \leq 0.2\text{A}$, $\text{RUN} = 2\text{V}$		1.5		%
V_{OUT1} Ripple (RMS)	$I_{\text{OUT}} = 0.1\text{A}$, 1MHz BW		20		mV
Input Short-Circuit Current	V_{OUT1} Shorted		30		mA
RUN Pin Input Threshold	RUN Pin Rising	1.18	1.24	1.30	V
RUN Pin Current	$V_{\text{RUN}} = 1\text{V}$ $V_{\text{RUN}} = 1.3\text{V}$			2.5	μA
				0.1	μA
SS Threshold			0.7		V
SS Sourcing Current	SS = 0V		-10		μA
BIAS Current	$V_{\text{IN}} = 12\text{V}$, BIAS = 5V, $I_{\text{LOAD1}} = 100\text{mA}$		8		mA
Minimum BIAS Voltage (Note 5)	$I_{\text{LOAD1}} = 100\text{mA}$			3.1	V
LDO (V_{OUT2}) Minimum Input DC Voltage	(Note 6)		1.8	2.3	V
V_{OUT2} Voltage Range	$V_{\text{OUT1}} = 16\text{V}$, R_{ADJ2} Open, No Load (Note 6) $V_{\text{OUT1}} = 16\text{V}$, $R_{\text{ADJ2}} = 41.2\text{k}$, No Load (Note 6)			1.22	V
				15.8	V
ADJ2 Pin Voltage	$V_{\text{OUT1}} = 2\text{V}$, $I_{\text{OUT2}} = 1\text{mA}$ (Note 6) $V_{\text{OUT1}} = 2\text{V}$, $I_{\text{OUT2}} = 1\text{mA}$ (Note 6)	●	1.19	1.22	V
				1.25	V
V_{OUT2} Line Regulation	$2\text{V} < V_{\text{OUT1}} < 16\text{V}$, $I_{\text{OUT2}} = 1\text{mA}$ (Note 6)		1	5	mV
V_{OUT2} Load Regulation	$V_{\text{OUT1}} = 5\text{V}$, $10\text{mA} \leq I_{\text{OUT2}} \leq 300\text{mA}$ (Note 6)		2	10	mV
LDO Dropout Voltage	$I_{\text{OUT2}} = 10\text{mA}$ (Note 6) $I_{\text{OUT2}} = 100\text{mA}$ (Note 6) $I_{\text{OUT2}} = 300\text{mA}$ (Note 6)			0.25	V
				0.34	V
				0.43	V
V_{OUT2} Ripple (RMS)	$C_{\text{BYP}} = 0.01\mu\text{F}$, $I_{\text{OUT2}} = 300\text{mA}$, BW = 100Hz to 100kHz (Note 6)		20		μV_{RMS}

Note 1: Stresses beyond those listed under Absolute Maximum Ratings may cause permanent damage to the device. Exposure to any Absolute Maximum Rating condition for extended periods may affect device reliability and lifetime.

Note 2: $V_{\text{IN}} + V_{\text{OUT1}}$ is defined as the sum of:

$$(V_{\text{IN}} - \text{GND}) + (V_{\text{OUT1}} - V_{\text{OUT}^-})$$

Note 3: The LTM8058 isolation is tested at 3kV DC for one second.

Note 4: The LTM8058E is guaranteed to meet performance specifications from 0°C to 125°C . Specifications over the -40°C to 125°C internal temperature range are assured by design, characterization and correlation with statistical process controls. LTM8058I is guaranteed to meet

specifications over the full -40°C to 125°C internal operating temperature range. The LTM8058MP is guaranteed to meet specifications over the full -55°C to 125°C internal operating temperature range. Note that the maximum internal temperature is determined by specific operating conditions in conjunction with board layout, the rated package thermal resistance and other environmental factors.

Note 5: This is the BIAS pin voltage at which the internal circuitry is powered through the BIAS pin and not the integrated regulator. See BIAS Pin Considerations for details.

Note 6: $V_{\text{RUN}} = 0\text{V}$ (Flyback not running), but the V_{OUT2} post regulator is powered by applying a voltage to V_{OUT1} .

TYPICAL PERFORMANCE CHARACTERISTICS Unless otherwise noted, operating conditions are as in Table 1 ($T_A = 25^\circ\text{C}$).

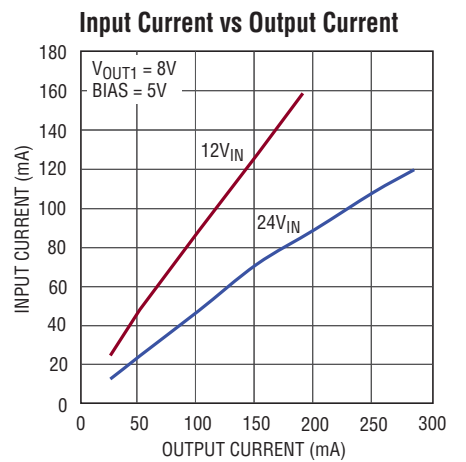
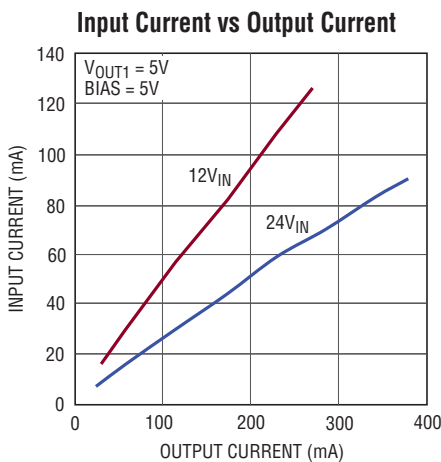
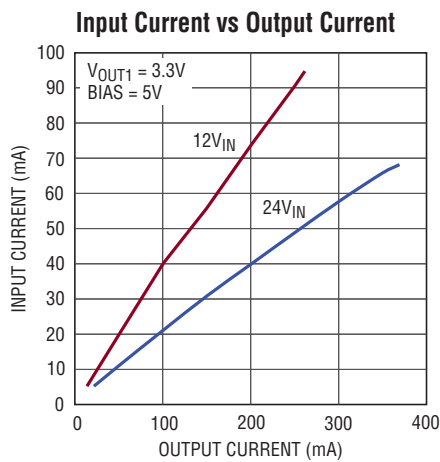
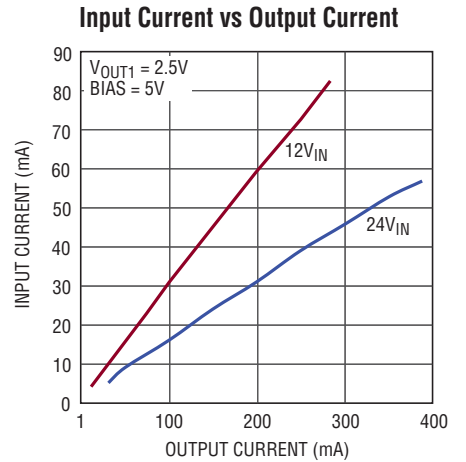
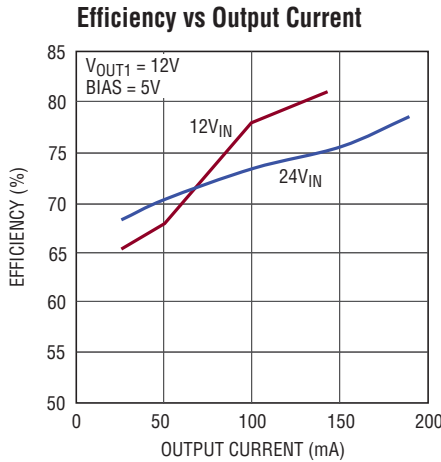
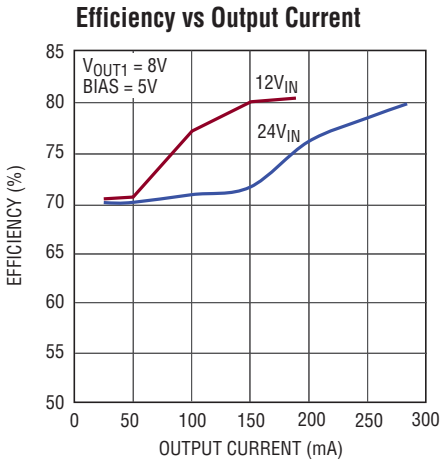
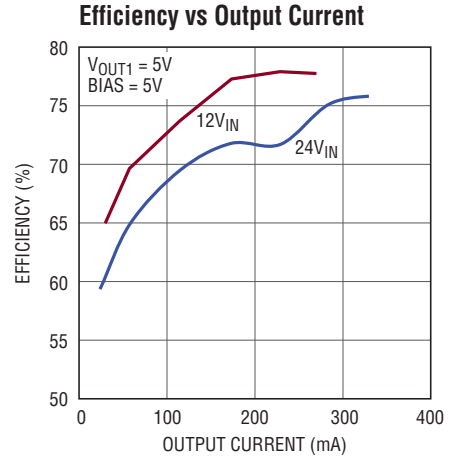
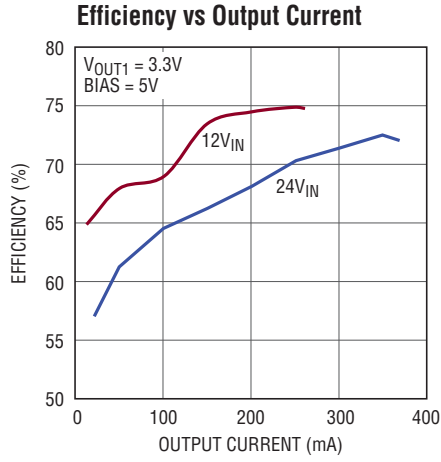
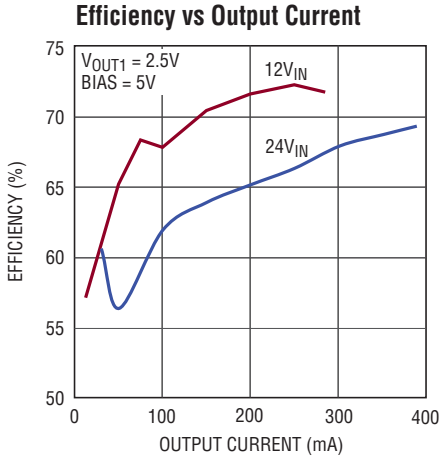

TYPICAL PERFORMANCE CHARACTERISTICS Unless otherwise noted, operating conditions are as in Table 1 ($T_A = 25^\circ\text{C}$).

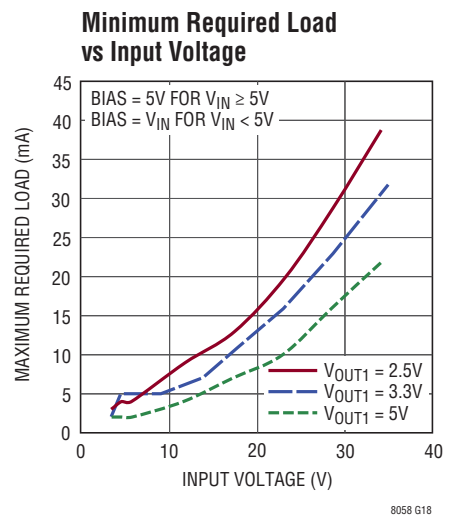
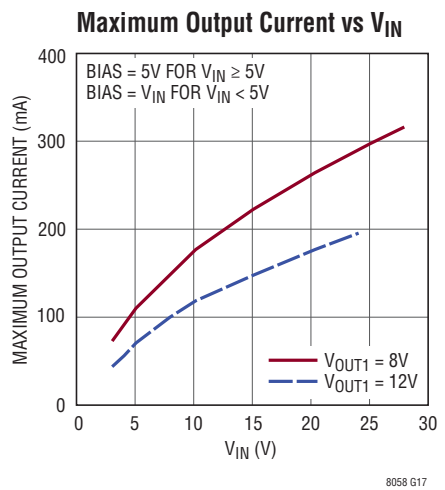
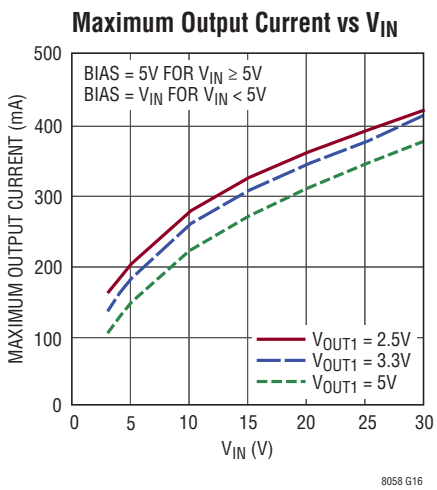
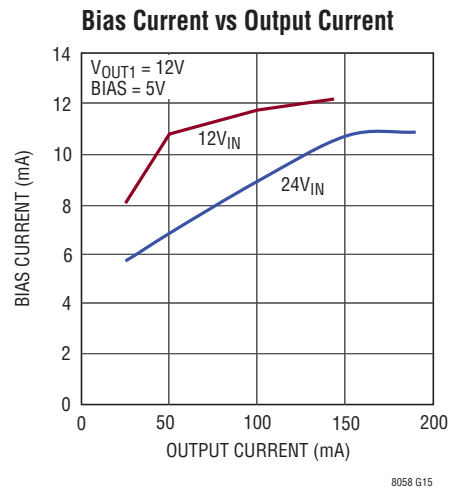
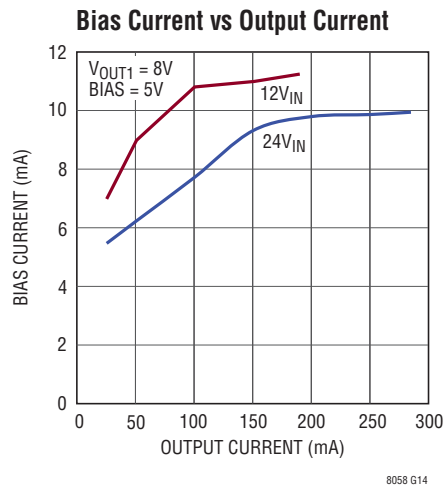
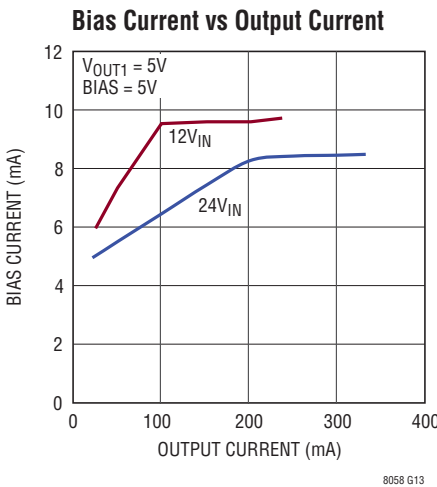
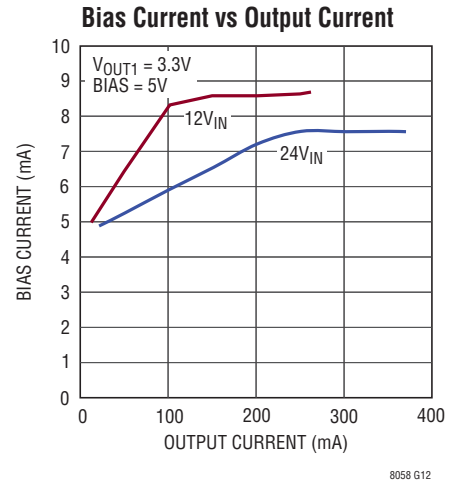
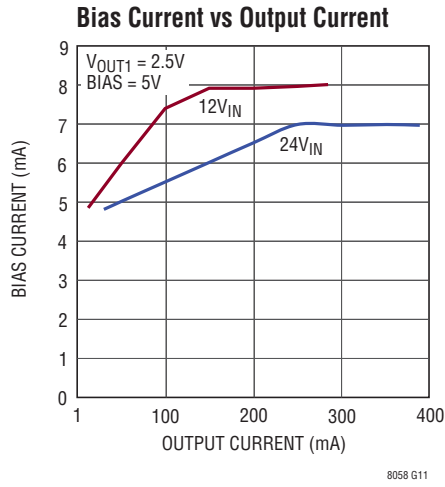
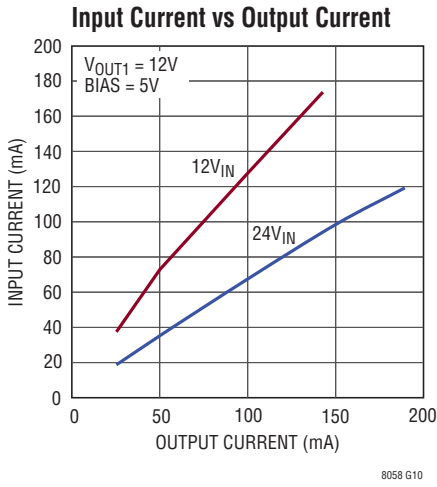

TYPICAL PERFORMANCE CHARACTERISTICS Unless otherwise noted, operating conditions are as in Table 1 ($T_A = 25^\circ\text{C}$).

Minimum Required Load vs Input Voltage

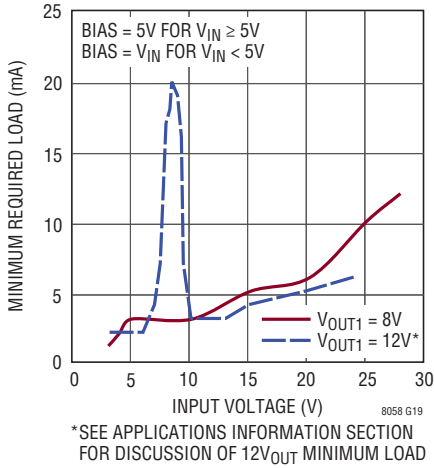

Typical Output Ripple 100mA Output Current, $V_{IN} = 12\text{V}$

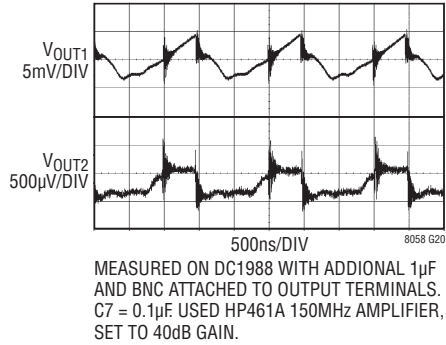

DC1988 V_{OUT1} Start-Up Behavior for Different C_{SS} Values

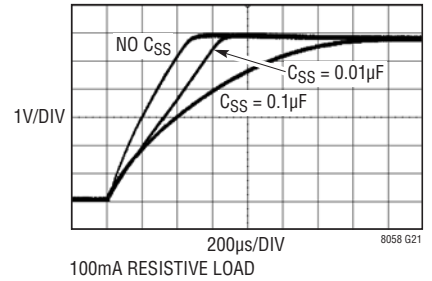

Typical Switching Frequency vs Output Current Stock DC1988A

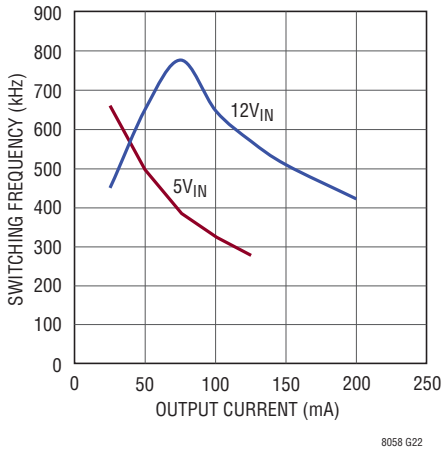

Input Current vs V_{IN} , V_{OUT1} Shorted

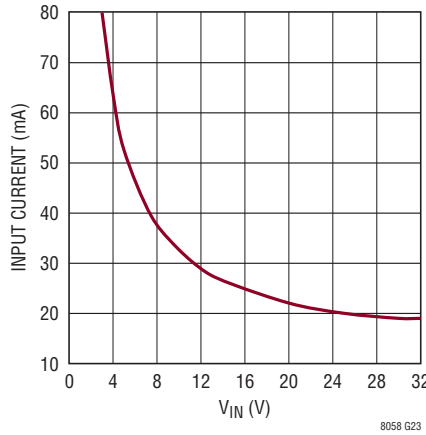

Input Current vs V_{IN} , V_{OUT2} Shorted

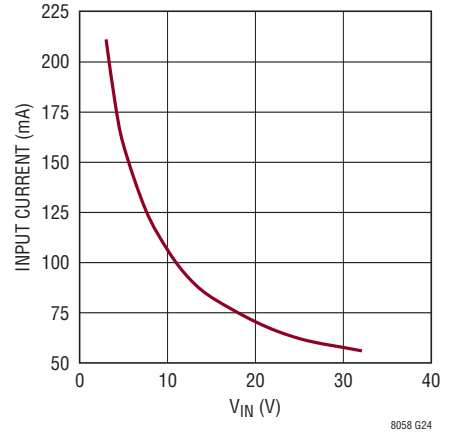

V_{OUT2} Dropout

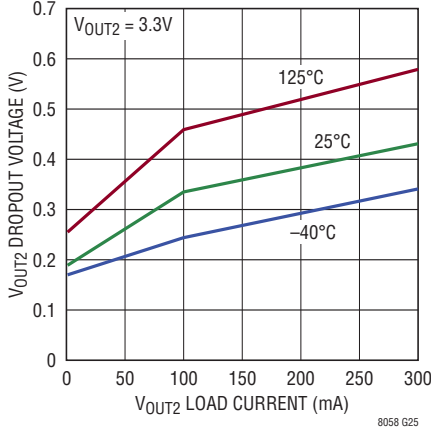

Junction Temperature Rise vs Load Current

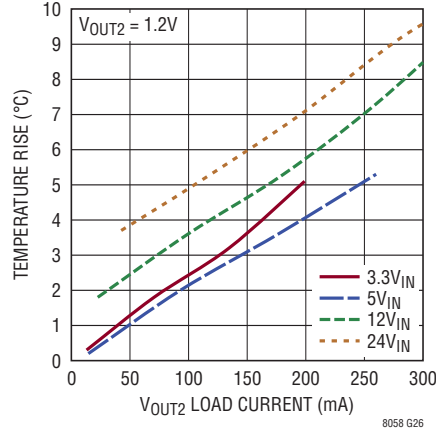

Junction Temperature Rise vs Load Current

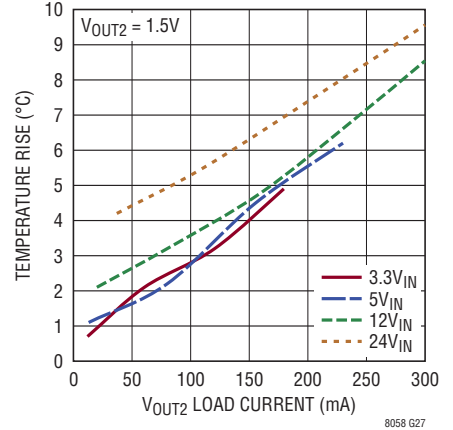

TYPICAL PERFORMANCE CHARACTERISTICS Unless otherwise noted, operating conditions are as in Table 1 ($T_A = 25^\circ\text{C}$).

Junction Temperature Rise vs Load Current

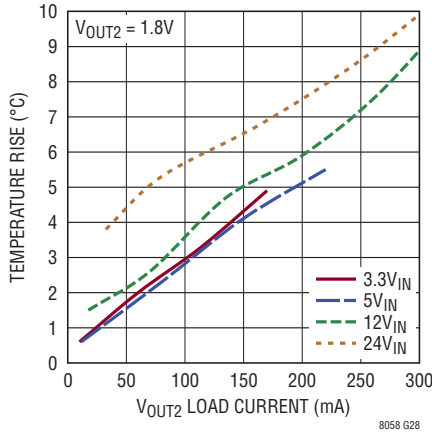

Junction Temperature Rise vs Load Current

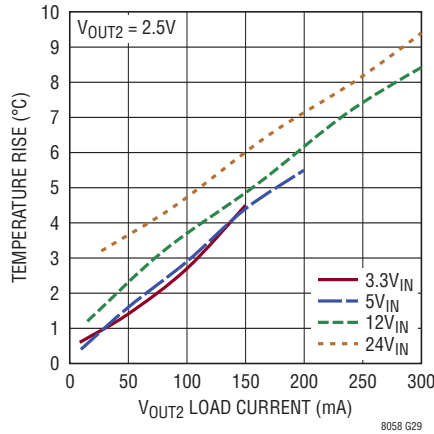

Junction Temperature Rise vs Load Current

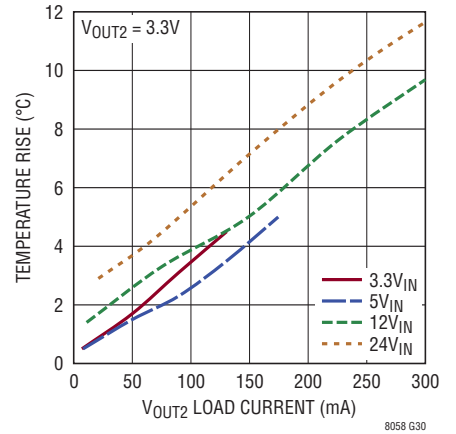

Junction Temperature Rise vs Load Current

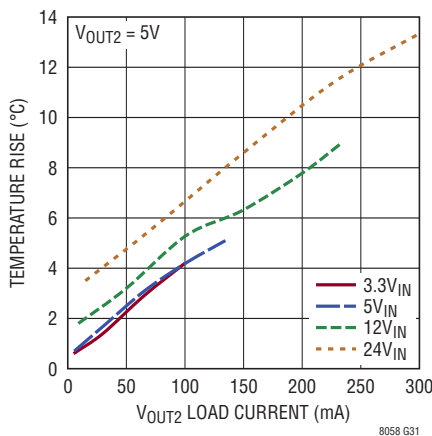

Junction Temperature Rise vs Load Current

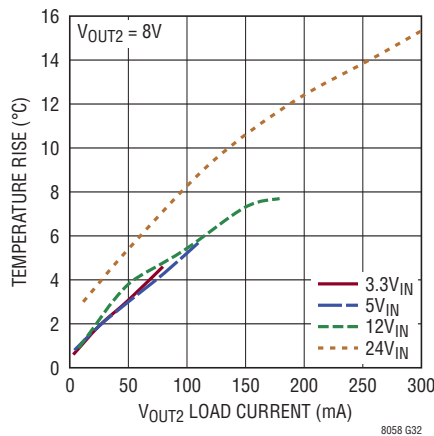

Junction Temperature Rise vs Load Current

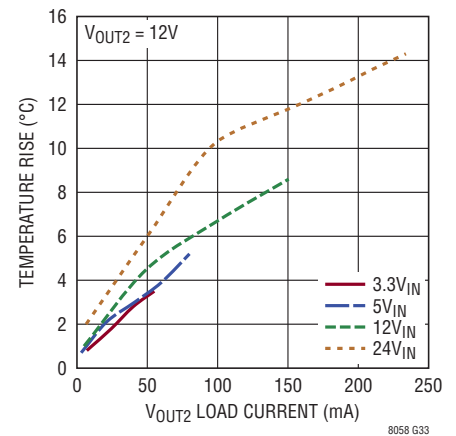

PIN FUNCTIONS

V_{OUT1} (Bank 1): V_{OUT1} and V_{OUT⁻} comprise the isolated output of the LTM8058 flyback stage. Apply an external capacitor between V_{OUT1} and V_{OUT⁻}. Do not allow V_{OUT⁻} to exceed V_{OUT1}.

V_{OUT⁻} (Bank 2): V_{OUT⁻} is the return for both V_{OUT1} and V_{OUT2}. V_{OUT1} and V_{OUT⁻} comprise the isolated output of the LTM8058. In most applications, the bulk of the heat flow out of the LTM8058 is through the GND and V_{OUT⁻} pads, so the printed circuit design has a large impact on the thermal performance of the part. See the PCB Layout and Thermal Considerations sections for more details. Apply an external capacitor between V_{OUT1} and V_{OUT⁻}.

V_{OUT2} (Bank 3): The output of the secondary side linear post regulator. Apply the load and output capacitor between V_{OUT2} and V_{OUT⁻}. See the Applications Information section for more information on output capacitance and reverse output characteristics.

GND (Bank 4): This is the local ground of the LTM8058 primary. In most applications, the bulk of the heat flow out of the LTM8058 is through the GND and V_{OUT⁻} pads, so the printed circuit design has a large impact on the thermal performance of the part. See the PCB Layout and Thermal Considerations sections for more details.

V_{IN} (Bank 5): V_{IN} supplies current to the LTM8058's internal regulator and to the integrated power switch. These pins must be locally bypassed with an external, low ESR capacitor.

ADJ2 (pin A2): This is the input to the error amplifier of the secondary side LDO post regulator. This pin is internally clamped to ±7V. The ADJ2 pin voltage is 1.22V referenced to V_{OUT⁻} and the output voltage range is 1.22V to 12V. Apply a resistor from this pin to V_{OUT⁻}, using the equation $R_{ADJ2} = 608.78 / (V_{OUT2} - 1.22) \text{ k}\Omega$. If the post regulator is not used, leave this pin floating.

BYP (Pin B2): The BYP pin is used to bypass the reference of the LDO to achieve low noise performance from the linear post regulator. The BYP pin is clamped internally to ±0.6V relative to V_{OUT⁻}. A small capacitor from V_{OUT2} to this pin will bypass the reference to lower the output voltage noise. A maximum value of 0.01μF can be used for reducing output voltage noise to a typical 20μV_{RMS} over a 100Hz to 100kHz bandwidth. If not used, this pin must be left unconnected.

RUN (Pin F3): A resistive divider connected to V_{IN} and this pin programs the minimum voltage at which the LTM8058 will operate. Below 1.24V, the LTM8058 does not deliver power to the secondary. Above 1.24V, power will be delivered to the secondary and 10μA will be fed into the SS pin. When RUN is less than 1.24V, the pin draws 2.5μA, allowing for a programmable hysteresis. Do not allow a negative voltage (relative to GND) on this pin.

ADJ1 (Pins G7): Apply a resistor from this pin to GND to set the output voltage V_{OUT1} relative to V_{OUT⁻}, using the recommended value given in Table 1. If Table 1 does not list the desired V_{OUT1} value, the equation

$$R_{ADJ1} = 28.4 \left(V_{OUT1}^{-0.879} \right) \text{ k}\Omega$$

may be used to approximate the value. To the seasoned designer, this exponential equation may seem unusual. The equation is exponential due to nonlinear current sources that are used to temperature compensate the regulation.

BIAS (Pin H5): This pin supplies the power necessary to operate the LTM8058. It must be locally bypassed with a low ESR capacitor of at least 4.7μF. Do not allow this pin voltage to rise above V_{IN}.

SS (Pin H6): Place a soft-start capacitor here to limit inrush current and the output voltage ramp rate. Do not allow a negative voltage (relative to GND) on this pin.

BLOCK DIAGRAM

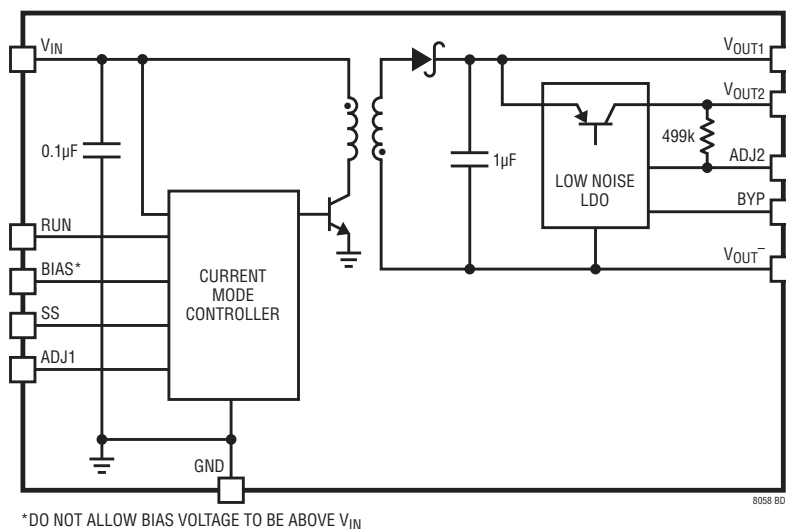

OPERATION

The LTM8058 is a stand-alone isolated flyback switching DC/DC power supply that can deliver up to 440mA of output current. This module provides a regulated output voltage programmable via one external resistor from 2.5V to 13V. It is also equipped with a high performance linear post regulator. The input voltage range of the LTM8058 is 3.1V to 31V. Given that the LTM8058 is a flyback converter, the output current depends upon the input and output voltages, so make sure that the input voltage is high enough to support the desired output voltage and load current. The Typical Performance Characteristics section gives several graphs of the maximum load versus V_{IN} for several output voltages.

A simplified block diagram is given. The LTM8058 contains a current mode controller, power switching element, power transformer, power Schottky diode, a modest amount of input and output capacitance, and a high performance linear post regulator.

The LTM8058 has a galvanic primary to secondary isolation rating of 2kV AC. This is verified by applying 3kV DC between the primary to secondary for 1 second. Note that the 2kV AC isolation is verified by a 3kV DC test. The peak voltage of a 2kV AC waveform is 2.83kV DC, so 3kV DC is applied. For details please refer to the Isolation, Working Voltage and Safety Compliance section. The LTM8058 is a UL 60950 recognized component.

An internal regulator provides power to the control circuitry. The bias regulator normally draws power from the V_{IN} pin, but if the BIAS pin is connected to an external voltage higher than 3.1V, bias power will be drawn from the external source, improving efficiency. V_{BIAS} must not exceed V_{IN} . The RUN pin is used to turn on or off the LTM8058, disconnecting the output and reducing the input current to 1µA or less.

The LTM8058 is a variable frequency device. For a fixed input and output voltage, the frequency increases as the load increases. For light loads, the current through the internal transformer may be discontinuous.

The post regulator is a high performance 300mA low dropout regulator with micropower quiescent current and shutdown. The device is capable of supplying 300mA at a dropout voltage of 430mV. Output voltage noise can be lowered to 20µV_{RMS} over a 100Hz to 100kHz bandwidth with the addition of a 0.01µF reference bypass capacitor. Additionally, this reference bypass capacitor will improve transient response of the regulator, lowering the settling time for transient load conditions. The linear regulator is protected against both reverse input and reverse output voltages.

APPLICATIONS INFORMATION

For most applications, the design process is straight forward, summarized as follows:

1. Look at Table 1a (or Table 1b, if the post linear regulator is used) and find the row that has the desired input range and output voltage.
2. Apply the recommended C_{IN} , C_{OUT1} , C_{OUT2} , R_{ADJ1} , R_{ADJ2} and C_{BYP} if required.
3. Connect BIAS as indicated, or tie to an external source up to 15V or V_{IN} , whichever is less.

While these component combinations have been tested for proper operation, it is incumbent upon the user to verify proper operation over the intended system's line, load and environmental conditions. Bear in mind that the maximum output current may be limited by junction temperature, the relationship between the input and output voltage magnitude and polarity and other factors. Please refer to the graphs in the Typical Performance Characteristics section for guidance.

Capacitor Selection Considerations

The C_{IN} , C_{OUT1} and C_{OUT2} capacitor values in Table 1 are the minimum recommended values for the associated operating conditions. Applying capacitor values below those

indicated in Table 1 is not recommended, and may result in undesirable operation. Using larger values is generally acceptable, and can yield improved dynamic response, if it is necessary. Again, it is incumbent upon the user to verify proper operation over the intended system's line, load and environmental conditions.

Ceramic capacitors are small, robust and have very low ESR. However, not all ceramic capacitors are suitable. X5R and X7R types are stable over temperature and applied voltage and give dependable service. Other types, including Y5V and Z5U have very large temperature and voltage coefficients of capacitance. In an application circuit they may have only a small fraction of their nominal capacitance resulting in much higher output voltage ripple than expected.

A final precaution regarding ceramic capacitors concerns the maximum input voltage rating of the LTM8058. A ceramic input capacitor combined with trace or cable inductance forms a high-Q (underdamped) tank circuit. If the LTM8058 circuit is plugged into a live supply, the input voltage can ring to much higher than its nominal value, possibly exceeding the device's rating. This situation is easily avoided; see the Hot-Plugging Safely section.

LTM8058 Table 1a. Recommended Component Values and Configuration for Specific V_{OUT1} Voltages ($T_A = 25^\circ\text{C}$)

V_{IN}	V_{OUT1}	V_{BIAS}	C_{IN}	C_{OUT1}	R_{ADJ1}
3.1V to 31V	2.5V	3.1V to 15V or Open	2.2 μF , 50V, 1206	100 μF , 6.3V, 1210	12.4k
3.1V to 31V	3.3V	3.1V to 15V or Open	2.2 μF , 50V, 1206	100 μF , 6.3V, 1210	10k
3.1V to 29V	5V	3.1V to 15V or Open	2.2 μF , 50V, 1206	22 μF , 16V, 1210	6.98k
3.1V to 26V	8V	3.1V to 15V or Open	2.2 μF , 50V, 1206	22 μF , 10V, 1206	4.53k
3.1V to 24V	12V	3.1V to 15V or Open	2.2 μF , 25V, 0805	10 μF , 16V, 1210	3.16k/8.2pF*
9V to 15V	2.5V	V_{IN}	2.2 μF , 50V, 1206	100 μF , 6.3V, 1210	12.4k
9V to 15V	3.3V	V_{IN}	2.2 μF , 50V, 1206	47 μF , 6.3V, 1210	10k
9V to 15V	5V	V_{IN}	2.2 μF , 50V, 1206	22 μF , 16V, 1210	6.98k
9V to 15V	8V	V_{IN}	2.2 μF , 50V, 1206	22 μF , 10V, 1206	4.53k
9V to 15V	12V	V_{IN}	2.2 μF , 25V, 0805	10 μF , 16V, 1210	3.16k
18V to 31V	2.5V	3.1V to 15V or Open	2.2 μF , 50V, 1206	100 μF , 6.3V, 1210	12.4k
18V to 31V	3.3V	3.1V to 15V or Open	2.2 μF , 50V, 1206	47 μF , 6.3V, 1210	10k
18V to 29V	5V	3.1V to 15V or Open	2.2 μF , 50V, 1206	22 μF , 16V, 1210	6.98k
18V to 26V	8V	3.1V to 15V or Open	2.2 μF , 50V, 1206	22 μF , 10V, 1206	4.53k
18V to 24V	12V	3.1V to 15V or Open	2.2 μF , 50V, 1206	10 μF , 16V, 1210	3.16k/8.2pF*

Note: Do not allow BIAS to exceed V_{IN} , a bulk input capacitor is required. If BIAS is open, the minimum V_{IN} is 4.3V.

*Connect 3.16k in parallel with 8.2pF from ADJ1 to GND

APPLICATIONS INFORMATION

LTM8058 Table 1b. Recommended Component Values and Configuration for Specific V_{OUT2} Voltages ($T_A = 25^\circ\text{C}$)

V_{IN}	V_{OUT1}	V_{OUT2}	V_{BIAS}	C_{IN}	C_{OUT1}	C_{OUT2}	R_{ADJ1}	R_{ADJ2}
3.1V to 31V	2.3V	1.2V	3.1V to 15V or Open	2.2 μF , 50V, 1206	100 μF , 6.3V, 1210	10 μF , 6.3V, 1206	133k	Open
3.1V to 31V	2.3V	1.5V	3.1V to 15V or Open	2.2 μF , 50V, 1206	100 μF , 6.3V, 1210	10 μF , 6.3V, 1206	133k	2.32M
3.1V to 31V	2.3V	1.8V	3.1V to 15V or Open	2.2 μF , 50V, 1206	100 μF , 6.3V, 1210	10 μF , 6.3V, 1206	13.3k	1.07M
3.1V to 31V	3.08V	2.5V	3.1V to 15V or Open	2.2 μF , 50V, 1206	100 μF , 6.3V, 1210	10 μF , 6.3V, 1206	10.5k	487k
3.1V to 31V	3.92V	3.3V	3.1V to 15V or Open	2.2 μF , 50V, 1206	47 μF , 6.3V, 1210	10 μF , 6.3V, 1206	8.66k	294k
3.1V to 29V	5.7V	5V	3.1V to 15V or Open	2.2 μF , 50V, 1206	22 μF , 16V, 1210	10 μF , 6.3V, 1206	6.19k	162k
3.1V to 26V	8.85V	8V	3.1V to 15V or Open	2.2 μF , 50V, 1206	22 μF , 10V, 1206	10 μF , 10V, 1206	4.12k	88.7k
3.1V to 21V	13V	12V	3.1V to 15V or Open	2.2 μF , 25V, 0805	10 μF , 16V, 1210	22 μF , 16V, 1206	2.94k/22pF*	56.2k
9V to 15V	2.3V	1.2V	V_{IN}	2.2 μF , 50V, 1206	100 μF , 6.3V, 1210	10 μF , 6.3V, 1206	133k	Open
9V to 15V	2.3V	1.5V	V_{IN}	2.2 μF , 50V, 1206	100 μF , 6.3V, 1210	10 μF , 6.3V, 1206	133k	2.32M
9V to 15V	2.3V	1.8V	V_{IN}	2.2 μF , 50V, 1206	100 μF , 6.3V, 1210	10 μF , 6.3V, 1206	13.3k	1.07M
9V to 15V	3.08V	2.5V	V_{IN}	2.2 μF , 50V, 1206	100 μF , 6.3V, 1210	10 μF , 6.3V, 1206	10.5k	487k
9V to 15V	3.92V	3.3V	V_{IN}	2.2 μF , 50V, 1206	47 μF , 6.3V, 1210	10 μF , 6.3V, 1206	8.66k	294k
9V to 15V	5.7V	5V	V_{IN}	2.2 μF , 50V, 1206	22 μF , 16V, 1210	10 μF , 6.3V, 1206	6.19k	162k
9V to 15V	8.85V	8V	V_{IN}	2.2 μF , 50V, 1206	22 μF , 10V, 1206	10 μF , 10V, 1206	4.12k	88.7k
9V to 15V	13V	12V	V_{IN}	2.2 μF , 25V, 0805	10 μF , 16V, 1210	22 μF , 16V, 1206	2.94k/22pF*	56.2k
18V to 31V	2.3V	1.2V	3.1V to 15V or Open	2.2 μF , 50V, 1206	100 μF , 6.3V, 1210	10 μF , 6.3V, 1206	133k	Open
18V to 31V	2.3V	1.5V	3.1V to 15V or Open	2.2 μF , 50V, 1206	100 μF , 6.3V, 1210	10 μF , 6.3V, 1206	133k	2.32M
18V to 31V	2.3V	1.8V	3.1V to 15V or Open	2.2 μF , 50V, 1206	100 μF , 6.3V, 1210	10 μF , 6.3V, 1206	13.3k	1.07M
18V to 31V	3.08V	2.5V	3.1V to 15V or Open	2.2 μF , 50V, 1206	100 μF , 6.3V, 1210	10 μF , 6.3V, 1206	10.5k	487k
18V to 31V	3.92V	3.3V	3.1V to 15V or Open	2.2 μF , 50V, 1206	47 μF , 6.3V, 1210	10 μF , 6.3V, 1206	8.66k	294k
18V to 29V	5.7V	5V	3.1V to 15V or Open	2.2 μF , 50V, 1206	22 μF , 16V, 1210	10 μF , 6.3V, 1206	6.19k	162k
18V to 26V	8.85V	8V	3.1V to 15V or Open	2.2 μF , 50V, 1206	22 μF , 10V, 1206	10 μF , 10V, 1206	4.12k	88.7k

Note: Do not allow BIAS to exceed V_{IN} , a bulk input capacitor is required. If BIAS is open, the minimum V_{IN} is 4.3V.

*Connect 2.94k in parallel with 22pF from ADJ1 to GND.

BIAS Pin Considerations

The BIAS pin is the output of an internal linear regulator that powers the LTM8058's internal circuitry. It is set to 3V and must be decoupled with a low ESR capacitor of at least 4.7 μF . The LTM8058 will run properly without applying a voltage to this pin, but will operate more efficiently and dissipate less power if a voltage between 3.1V and V_{IN} is applied. At low V_{IN} , the LTM8058 will be able to deliver more output current if BIAS is 3.1V or greater. Up to 31V may be applied to this pin, but a high BIAS voltage will cause excessive power dissipation in the internal circuitry. For applications with an input voltage less than 15V, the BIAS pin is typically connected directly to the V_{IN} pin. For input voltages greater than 15V, it is preferred to leave the BIAS pin separate from the V_{IN} pin, either powered from a separate voltage source or left running from the internal

regulator. This has the added advantage of keeping the physical size of the BIAS capacitor small. Do not allow BIAS to rise above V_{IN} .

Soft-Start

For many applications, it is necessary to minimize the inrush current at start-up. The built-in soft-start circuit significantly reduces the start-up current spike and output voltage overshoot by applying a capacitor from SS to GND. When the LTM8058 is enabled, whether from V_{IN} reaching a sufficiently high voltage or RUN being pulled high, the LTM8058 will source approximately 10 μA out of the SS pin. As this current gradually charges the capacitor from SS to GND, the LTM8058 will correspondingly increase the power delivered to the output, allowing for a graceful turn-on ramp.

APPLICATIONS INFORMATION

Isolation, Working Voltage and Safety Compliance

The LTM8058 isolation is 100% hi-pot tested by tying all of the primary pins together, all of the secondary pins together and subjecting the two resultant circuits to a differential of 3kV DC for one second. This establishes the isolation voltage rating of the LTM8058 component.

The isolation rating of the LTM8058 is not the same as the working or operational voltage that the application will experience. This is subject to the application's power source, operating conditions, the industry where the end product is used and other factors that dictate design requirements such as the gap between copper planes, traces and component pins on the printed circuit board, as well as the type of connector that may be used. To maximize the allowable working voltage, the LTM8058 has two columns of solder balls removed to facilitate the printed circuit board design. The ball to ball pitch is 1.27mm, and the typical ball diameter is 0.78mm. Accounting for the missing columns and the ball diameter, the printed circuit board may be designed for a metal-to-metal separation of up to 3.03mm. This may have to be reduced somewhat to allow for tolerances in solder mask or other printed circuit board design rules. For those situations where information about the spacing of LTM8058 internal circuitry is required, the minimum metal to metal separation of the primary and secondary is 0.75mm.

To reiterate, the manufacturer's isolation voltage rating and the required working or operational voltage are often different numbers. In the case of the LTM8058, the isolation voltage rating is established by 100% hi-pot testing. The working or operational voltage is a function of the end product and its system level specifications. The actual required operational voltage is often smaller than the manufacturer's isolation rating.

The LTM8058 is a UL recognized component under UL 60950, file number E464570. The UL 60950 insulation category of the LTM8058 transformer is Functional. Considering UL 60950 Table 2N and the gap distances stated above, 3.03mm external and 0.75mm internal, the LTM8058 may be operated with up to 250V working voltage in a pollution degree 2 environment. The actual working voltage, insulation category, pollution degree and

other critical parameters for the specific end application depend upon the actual environmental, application and safety compliance requirements. It is therefore up to the user to perform a safety and compliance review to ensure that the LTM8058 is suitable for the intended application.

V_{OUT2} Post Regulator

V_{OUT2} is produced by a high performance low dropout 300mA regulator. At full load, its dropout is less than 430mV. Its output is set by applying a resistor from the R_{ADJ2} pin to GND; the value of R_{ADJ2} can be calculated by the equation:

$$R_{ADJ2} = \frac{608.78}{V_{OUT2} - 1.22} \text{ k}\Omega$$

ADJ1 and Line Regulation

For V_{OUT1} greater than 8V, parasitics in the transformer interacting with the controller cause a localized increase in minimum load. A small capacitor may need to be applied from ADJ1 to GND to ensure proper line regulation. Care must be taken when choosing this capacitor value. Too small or no capacitor will result in poor line regulation; in general, a larger capacitor is needed for higher V_{OUT1}. Too large of a capacitance will require excessive minimum load to maintain regulation.

The plots in Figure 1 show LTM8058 line regulation with three different capacitor values applied from ADJ1 to GND.

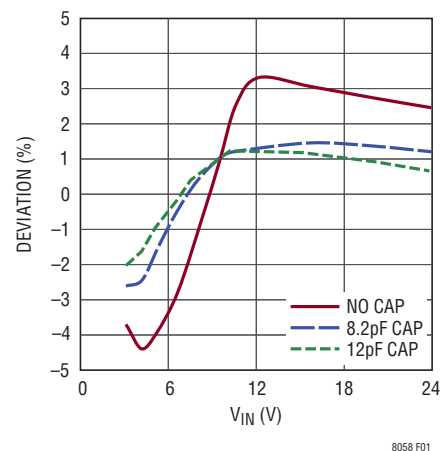

Figure 1. V_{OUT1} Line Regulation vs V_{IN}

APPLICATIONS INFORMATION

The plots in Figure 2 show the minimum load requirement for the same three capacitors.

Carefully choose the appropriate capacitor value for the intended application.

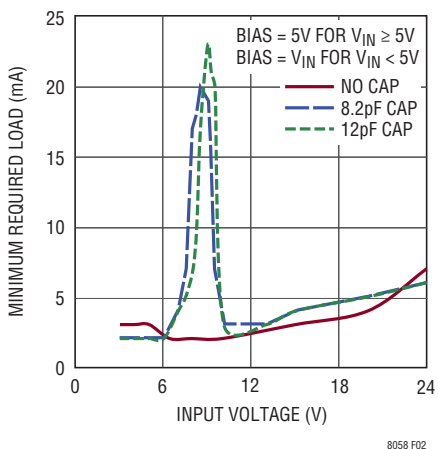

Figure 2. Minimum Required Load vs Input Voltage

V_{OUT1} to V_{OUT-} Reverse Voltage

The LTM8058 cannot tolerate a reverse voltage from V_{OUT1} to V_{OUT-} during operation. If V_{OUT-} raises above V_{OUT1} during operation, the LTM8058 may be damaged. To protect against this condition, a low forward drop power Schottky diode has been integrated into the LTM8058, anti-parallel to V_{OUT1}/V_{OUT-} . This can protect the output against many reverse voltage faults. Reverse voltage faults can be both steady state and transient. An example of a steady-state voltage reversal is accidentally misconnecting a powered LTM8058 to a negative voltage source. An example of transient voltage reversals is a momentary connection to a negative voltage. It is also possible to achieve a V_{OUT1} reversal if the load is short circuited through a long cable. The inductance of the long cable forms an LC tank circuit with the V_{OUT1} capacitance, which drives V_{OUT1} negative. Avoid these conditions.

V_{OUT2} Post Regulator Bypass Capacitance and Low Noise Performance

The V_{OUT2} linear regulator may be used with the addition of a $0.01\mu\text{F}$ bypass capacitor from V_{OUT} to the BYP pin to lower output voltage noise. A good quality low leakage

capacitor, such as a X5R or X7R ceramic, is recommended. This capacitor will bypass the reference of the regulator, lowering the output voltage noise to as low as $20\mu\text{V}_{\text{RMS}}$. Using a bypass capacitor has the added benefit of improving transient response.

Safety Rated Capacitors

Some applications require safety rated capacitors, which are high voltage capacitors that are specifically designed and rated for AC operation and high voltage surges. These capacitors are often certified to safety standards such as UL 60950, IEC 60950 and others. In the case of the LTM8058, a common application of a safety rated capacitor would be to connect it from GND to V_{OUT-} . To provide maximum flexibility, the LTM8058 does not include any components between GND and V_{OUT-} . Any safety capacitors must be added externally.

The specific capacitor and circuit configuration for any application depends upon the safety requirements of the system into which the LTM8058 is being designed. Table 2 provides a list of possible capacitors and their manufacturers. The application of a capacitor from GND to V_{OUT-} may also reduce the high frequency output noise on the output.

Table 2. Safety Rated Capacitors

MANUFACTURER	PART NUMBER	DESCRIPTION
Murata Electronics	GA343DR7GD472KW01L	4700pF, 250V AC, X7R, 4.5mm × 3.2mm Capacitor
Johanson Dielectrics	302R29W471KV3E-****-SC	470pF, 250V AC, X7R, 4.5mm × 2mm Capacitor
Syfer Technology	1808JA250102JCTSP	100pF, 250V AC, COG, 1808 Capacitor

PCB Layout

Most of the headaches associated with PCB layout have been alleviated or even eliminated by the high level of integration of the LTM8058. The LTM8058 is nevertheless a switching power supply, and care must be taken to minimize electrical noise to ensure proper operation. Even with the high level of integration, you may fail to achieve specified operation with a haphazard or poor layout. See

APPLICATIONS INFORMATION

Figure 3 for a suggested layout. Ensure that the grounding and heat sinking are acceptable.

A few rules to keep in mind are:

1. Place the R_{ADJ1} and R_{ADJ2} resistors as close as possible to their respective pins.
2. Place the C_{IN} capacitor as close as possible to the V_{IN} and GND connections of the LTM8058.
3. Place the C_{OUT1} capacitor as close as possible to V_{OUT1} and V_{OUT^-} . Likewise, place the C_{OUT2} capacitor as close as possible to V_{OUT2} and V_{OUT^-} .
4. Place the C_{IN} and C_{OUT} capacitors such that their ground current flow directly adjacent or underneath the LTM8058.
5. Connect all of the GND connections to as large a copper pour or plane area as possible on the top layer. Avoid breaking the ground connection between the external components and the LTM8058.
6. Use vias to connect the GND copper area to the board's internal ground planes. Liberally distribute these GND vias to provide both a good ground connection and thermal path to the internal planes of the printed circuit board. Pay attention to the location and density of the thermal vias in Figure 3. The LTM8058 can benefit from the heat sinking afforded by vias that connect to internal GND planes at these locations, due to their proximity to internal power handling components. The optimum number of thermal vias depends upon the printed circuit board design. For example, a board might use very small via holes. It should employ more thermal vias than a board that uses larger holes.

Hot-Plugging Safely

The small size, robustness and low impedance of ceramic capacitors make them an attractive option for the input bypass capacitor of the LTM8058. However, these capacitors can cause problems if the LTM8058 is plugged into a live supply (see Linear Technology Application Note 88 for a complete discussion). The low loss ceramic capacitor combined with stray inductance in series with the power source forms an underdamped tank circuit, and the voltage at the V_{IN} pin of the LTM8058 can ring to more than

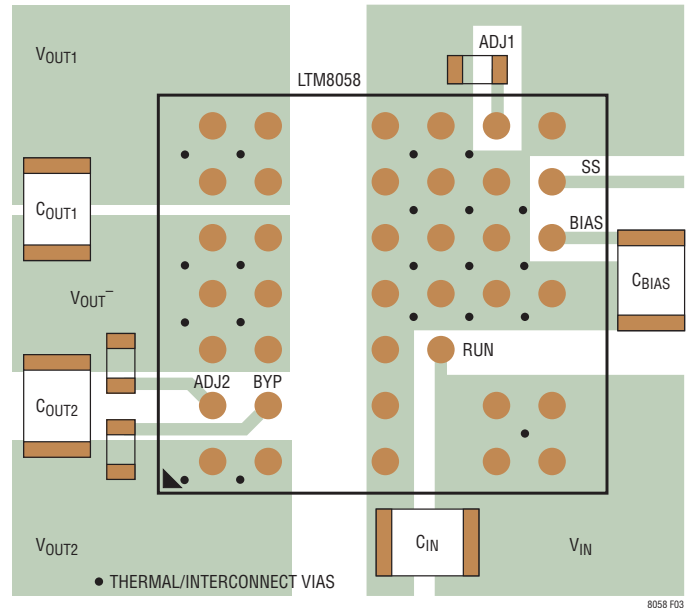

Figure 3. Layout Showing Suggested External Components, Planes and Thermal Vias

twice the nominal input voltage, possibly exceeding the LTM8058's rating and damaging the part. If the input supply is poorly controlled or the user will be plugging the LTM8058 into an energized supply, the input network should be designed to prevent this overshoot. This can be accomplished by installing a small resistor in series to V_{IN} , but the most popular method of controlling input voltage overshoot is adding an electrolytic bulk capacitor to the V_{IN} net. This capacitor's relatively high equivalent series resistance damps the circuit and eliminates the voltage overshoot. The extra capacitor improves low frequency ripple filtering and can slightly improve the efficiency of the circuit, though it can be a large component in the circuit.

Thermal Considerations

The LTM8058 output current may need to be derated if it is required to operate in a high ambient temperature. The amount of current derating is dependent upon the input voltage, output power and ambient temperature. The temperature rise curves given in the Typical Performance Characteristics section can be used as a guide. These curves were generated by the LTM8058 mounted to a 58cm² 4-layer FR4 printed circuit board. Boards of other sizes and layer count can exhibit different thermal behavior, so

APPLICATIONS INFORMATION

it is incumbent upon the user to verify proper operation over the intended system's line, load and environmental operating conditions.

For increased accuracy and fidelity to the actual application, many designers use FEA to predict thermal performance. To that end, the Pin Configuration section of the data sheet typically gives four thermal coefficients:

θ_{JA} : Thermal resistance from junction to ambient

$\theta_{JCbottom}$: Thermal resistance from junction to the bottom of the product case

θ_{JCtop} : Thermal resistance from junction to top of the product case

$\theta_{JCboard}$: Thermal resistance from junction to the printed circuit board.

While the meaning of each of these coefficients may seem to be intuitive, JEDEC has defined each to avoid confusion and inconsistency. These definitions are given in JESD 51-12, and are quoted or paraphrased as follows:

θ_{JA} is the natural convection junction-to-ambient air thermal resistance measured in a one cubic foot sealed enclosure. This environment is sometimes referred to as still air although natural convection causes the air to move. This value is determined with the part mounted to a JESD 51-9 defined test board, which does not reflect an actual application or viable operating condition.

$\theta_{JCbottom}$ is the junction-to-board thermal resistance with all of the component power dissipation flowing through the bottom of the package. In the typical μ Module converter, the bulk of the heat flows out the bottom of the package, but there is always heat flow out into the ambient environment. As a result, this thermal resistance value may be useful for comparing packages but the test conditions don't generally match the user's application.

θ_{JCtop} is determined with nearly all of the component power dissipation flowing through the top of the package. As the electrical connections of the typical μ Module converter are on the bottom of the package, it is rare for an application

to operate such that most of the heat flows from the junction to the top of the part. As in the case of $\theta_{JCbottom}$, this value may be useful for comparing packages but the test conditions don't generally match the user's application.

$\theta_{JCboard}$ is the junction-to-board thermal resistance where almost all of the heat flows through the bottom of the μ Module converter and into the board, and is really the sum of the $\theta_{JCbottom}$ and the thermal resistance of the bottom of the part through the solder joints and through a portion of the board. The board temperature is measured a specified distance from the package, using a two-sided, two-layer board. This board is described in JESD 51-9.

Given these definitions, it should now be apparent that none of these thermal coefficients reflects an actual physical operating condition of a μ Module converter. Thus, none of them can be individually used to accurately predict the thermal performance of the product. Likewise, it would be inappropriate to attempt to use any one coefficient to correlate to the junction temperature vs load graphs given in the product's data sheet. The only appropriate way to use the coefficients is when running a detailed thermal analysis, such as FEA, which considers all of the thermal resistances simultaneously.

A graphical representation of these thermal resistances is given in Figure 4.

The blue resistances are contained within the μ Module converter, and the green are outside.

The die temperature of the LTM8058 must be lower than the maximum rating of 125°C, so care should be taken in the layout of the circuit to ensure good heat sinking of the LTM8058. The bulk of the heat flow out of the LTM8058 is through the bottom of the module and the BGA pads into the printed circuit board. Consequently a poor printed circuit board design can cause excessive heating, resulting in impaired performance or reliability. Please refer to the PCB Layout section for printed circuit board design suggestions.

APPLICATIONS INFORMATION

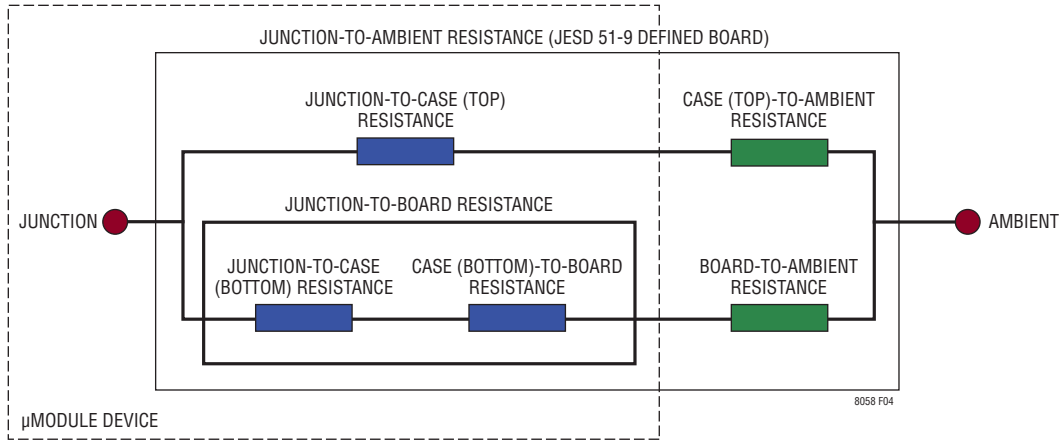
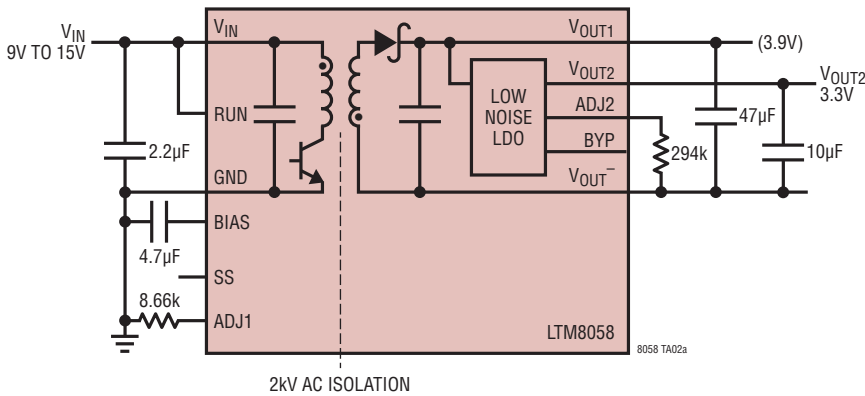

Figure 4

TYPICAL APPLICATIONS

3.3V Flyback Converter



V_{OUT2} Maximum Output Current vs V_{IN}

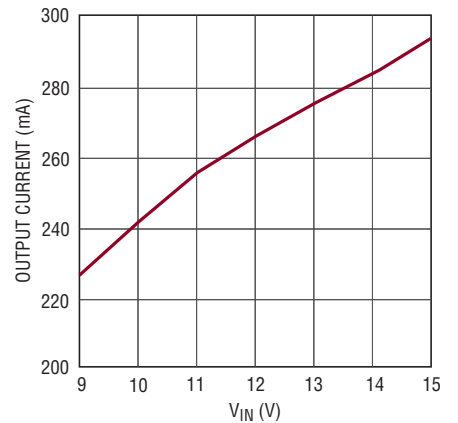

12V Flyback Converter with Low Noise Bypass

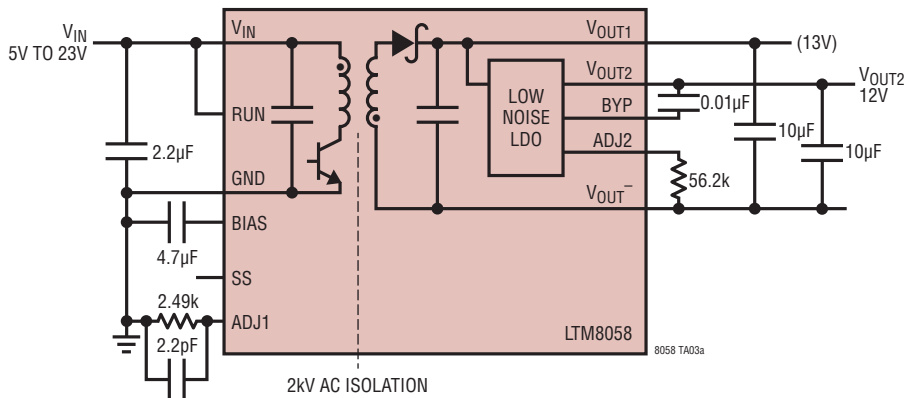

V_{OUT2} Maximum Output Current vs V_{IN}

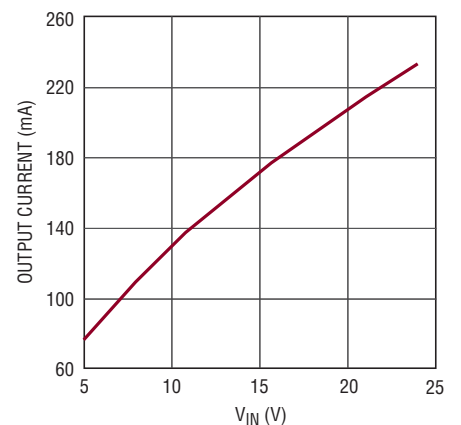

TYPICAL APPLICATIONS

3.3V and 2.5V Flyback Converter

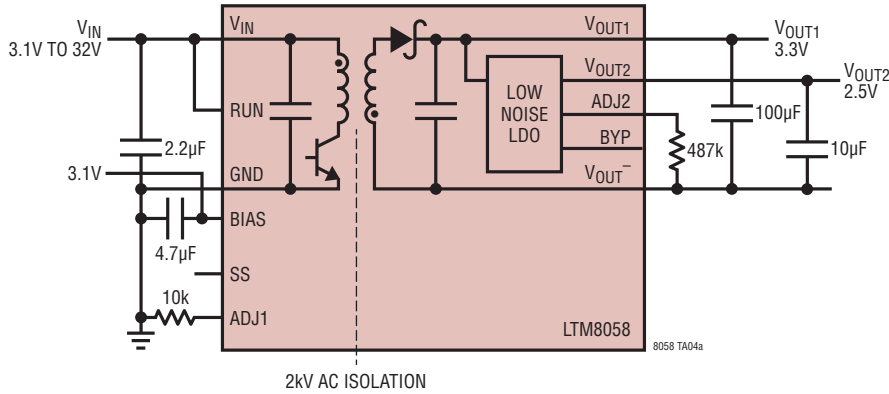

Total Maximum Output Current vs V_{IN}

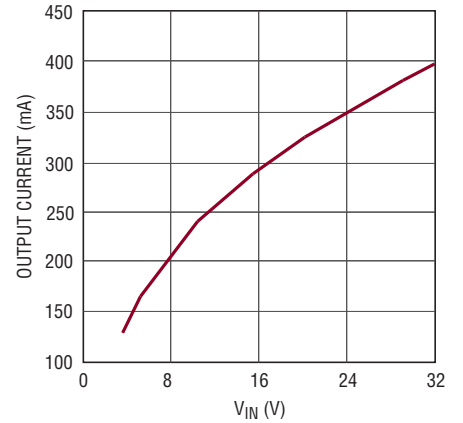

PACKAGE DESCRIPTION

Pin Assignment Table
(Arranged by Pin Number)

PIN	FUNCTION	PIN	FUNCTION	PIN	FUNCTION	PIN	FUNCTION	PIN	FUNCTION	PIN	FUNCTION	PIN	FUNCTION
A1	V_{OUT2}	B1	V_{OUT2}	C1	-	D1	-	E1	GND	F1	-	G1	V_{IN}
A2	ADJ2	B2	BYP	C2	-	D2	-	E2	GND	F2	-	G2	V_{IN}
A3	V_{OUT-}	B3	V_{OUT-}	C3	-	D3	-	E3	GND	F3	RUN	G3	-
A4	V_{OUT-}	B4	V_{OUT-}	C4	-	D4	-	E4	GND	F4	GND	G4	GND
A5	V_{OUT-}	B5	V_{OUT-}	C5	-	D5	-	E5	GND	F5	GND	G5	GND
A6	V_{OUT1}	B6	V_{OUT1}	C6	-	D6	-	E6	GND	F6	GND	G6	GND
A7	V_{OUT1}	B7	V_{OUT1}	C7	-	D7	-	E7	GND	F7	GND	G7	ADJ1
												H1	V_{IN}
												H2	V_{IN}
												H3	-
												H4	GND
												H5	BIAS
												H6	SS
												H7	GND

PACKAGE PHOTO

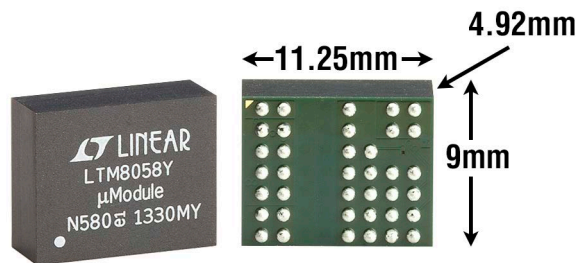

PACKAGE DESCRIPTION

Please refer to <http://www.linear.com/product/LTM8058#packaging> for the most recent package drawings.

BGA Package 38-Lead (11.25mm × 9.00mm × 4.92mm) (Reference LTC DWG # 05-08-1925 Rev B)

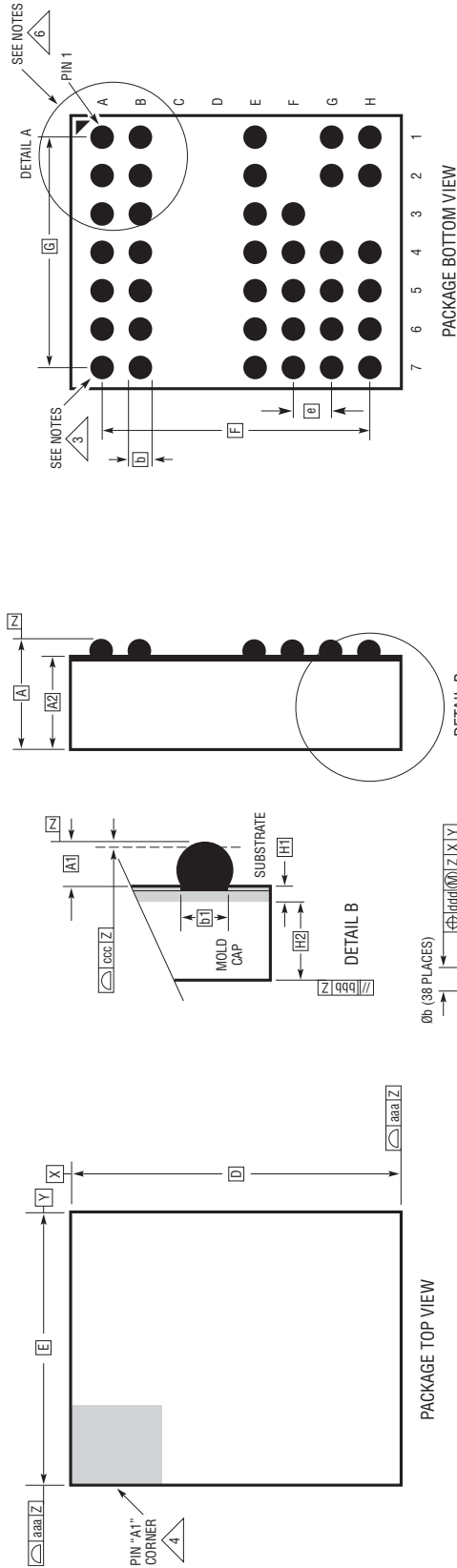

- NOTES:**
1. DIMENSIONING AND TOLERANCING PER ASME Y14.5M-1994
 2. ALL DIMENSIONS ARE IN MILLIMETERS
 3. BALL DESIGNATION PER JEDEC MS-028 AND JEP95
 4. DETAILS OF PIN #1 IDENTIFIER ARE OPTIONAL, BUT MUST BE LOCATED WITHIN THE ZONE INDICATED. THE PIN #1 IDENTIFIER MAY BE EITHER A MOLD OR MARKED FEATURE
 5. PRIMARY DATUM -Z- IS SEATING PLANE
 6. PACKAGE ROW AND COLUMN LABELING MAY VARY AMONG μ MODULE PRODUCTS. REVIEW EACH PACKAGE LAYOUT CAREFULLY

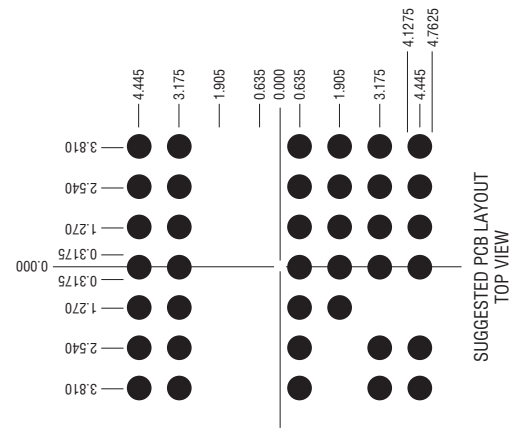
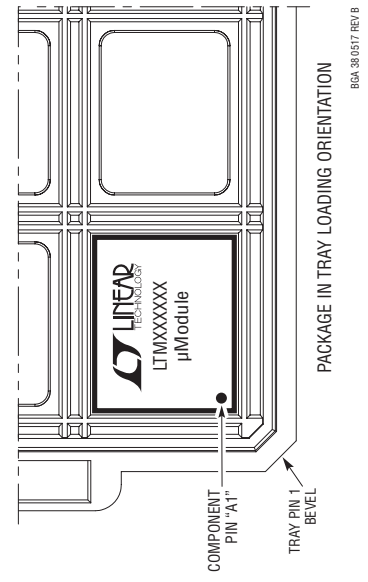

DIMENSIONS				
SYMBOL	MIN	NOM	MAX	NOTES
A	4.72	4.92	5.12	
A1	0.50	0.60	0.70	BALL HT
A2	4.22	4.32	4.42	
b	0.60	0.75	0.90	BALL DIMENSION
b1	0.60	0.63	0.66	PAD DIMENSION
D	11.25			
E	9.0			
e	1.27			
F	8.89			
G	7.62			
H1	0.27	0.32	0.37	SUBSTRATE THK
H2	3.95	4.00	4.05	MOLD CAP HT
aaa				0.15
bbb				0.10
ccc				0.20
ddd				0.30
eee				0.15
				TOTAL NUMBER OF BALLS: 38

REVISION HISTORY

REV	DATE	DESCRIPTION	PAGE NUMBER
A	11/14	Lowered Max Solder Temperature to 245°C (from 250°C) Pin Label Corrected: Was V_{OUT+} to V_{OUT1}	2 17
B	07/17	Connected RUN pin to V_{IN} in Typical Application circuit example	16, 17, 20

TYPICAL APPLICATION

5V Flyback Converter with Low Noise Bypass

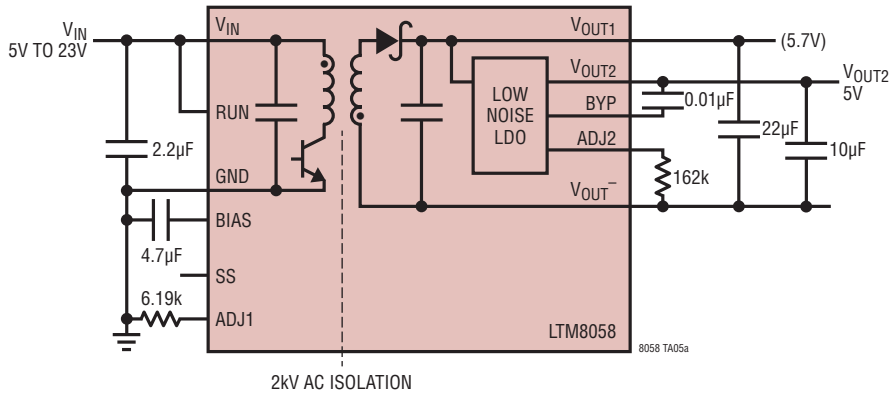

Total Output Current vs VIN

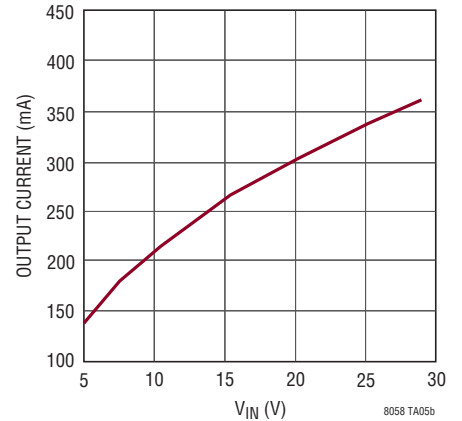

DESIGN RESOURCES

SUBJECT	DESCRIPTION
µModule Design and Manufacturing Resources	<p>Design:</p> <ul style="list-style-type: none"> • Selector Guides • Demo Boards and Gerber Files • Free Simulation Tools <p>Manufacturing:</p> <ul style="list-style-type: none"> • Quick Start Guide/Demo Manual • PCB Design, Assembly and Manufacturing Guidelines • Package and Board Level Reliability
µModule Regulator Products Search	<ol style="list-style-type: none"> 1. Sort table of products by parameters and download the result as a spread sheet. 2. Search using the Quick Power Search parametric table. <div style="border: 1px solid gray; padding: 5px; margin: 5px 0;"> <p>Quick Power Search</p> <p>Input V_{in} (Min) <input type="text"/> V V_{in} (Max) <input type="text"/> V</p> <p>Output V_{out} <input type="text"/> V I_{out} <input type="text"/> A</p> <p style="text-align: right;"><input type="button" value="Search"/></p> </div>
TechClip Videos	Quick videos detailing how to bench test electrical and thermal performance of µModule products.
Digital Power System Management	Linear Technology's family of digital power supply management ICs are highly integrated solutions that offer essential functions, including power supply monitoring, supervision, margining and sequencing, and feature EEPROM for storing user configurations and fault logging.

RELATED PARTS

Part Number	Description	Comments
LTM8057	LTM8058 without Low Noise Post Regulator	$2.5V \leq V_{OUT} \leq 12V$, 5% V_{OUT} Accuracy, UL60950 Recognized
LTM8046	Higher Output Power Than LTM8058, No Low Noise Post Regulator	2.5W Output Power, $1.8V \leq V_{OUT} \leq 12V$, 5% V_{OUT} Accuracy, UL60950 Recognized, 9mm x 15mm x 4.92mm BGA
LTM8048	Lower Isolation Voltage Than LTM8058	1.5W Output Power, 725V DC Isolation, $1.2V \leq V_{OUT} \leq 12V$
LTM8047	Lower Isolation Voltage Than LTM8058, No Low Noise Post Regulator	1.5W Output Power, 725V DC Isolation, $2.5V \leq V_{OUT} \leq 12V$
LTM8045	Non-isolated SEPIC (Step-Up & Down) Up to 700mA	$2.8V \leq V_{IN} \leq 18V$, $\pm 2.5V \leq V_{OUT} \leq \pm 15V$, Synchronizable, 6.25mm x 11.25mm x 4.92mm BGA
LTM4605	Non-isolated Buck-Boost Up to 5A	$4.5V \leq V_{IN} \leq 20V$, $0.8 \leq V_{OUT} \leq 16V$, Synchronizable, 15mm x 15mm x 2.82mm BGA

8058fb

Mouser Electronics

Authorized Distributor

Click to View Pricing, Inventory, Delivery & Lifecycle Information:

[Analog Devices Inc.:](#)

[LTM8058IY#PBF](#) [LTM8058EY#PBF](#) [LTM8058MPY](#) [LTM8058IY](#) [LTM8058MPY#PBF](#)