

Leiditech' ESD line of devices help protect I/O ports on HDMI 1.3, portable video players, LCD & plasma TVs, USB 2.0, digital visual interface (DVI), and antenna switches. ESD devices shunt electrostatic discharge away from sensitive circuitry in HDTV equipment, printers, laptops, cellular phones, and other portable devices.

ESD devices offer many advantages over traditional protection devices, such as multi layer varistors (MLVs), which may degrade or distort the signal in high data rate circuits. Compared to transient voltage suppression (TVS) diodes and miniature gas discharge tubes (GDTs), ESD devices provide a more compact form factor and an economical solution for the shrinking profiles of today's compact information appliances.

Available in a range of form factors, our ESD protection devices provide low capacitance, and meet transmission line pulse (TLP) testing, as well as IEC61000-4-2 testing.

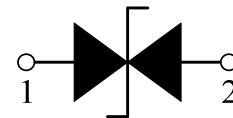

Equivalent Circuit

Benefits

- ESD protection for high frequency applications (HDMI 1.3)
- Smaller form factor for board space savings
- Helps protect sensitive electronic circuits against damage caused by electrostatic discharge (ESD) events
- Assists equipment to pass IEC 61000-4-2, level 4 testing

Features

- RoHS compliant
- Halogen free
(refers to: Br \leq 900ppm, Cl \leq 900ppm, Br+Cl \leq 1500ppm)
- 50pF(typical)capacitance
- Low-leakage current
- Low-clamping voltage
- Fast response time (< 1ns)
- Capable of withstanding numerous ESD strikes
- Compatible with standard reflow installation procedures
- Thick film technology
- Bi-directional protection

Applications

- HDMI 1.3 interfaces
- LCD & plasma TV
- Cellular phones
- Antennas
- Portable video players
- Portable devices (PDA, DSC, BlueTooth)
- Printer ports
- Satellite radios
- USB 2.0 and IEEE 1394 interfaces
- DVI
- GPS systems

Electrical Characteristics (T_A =25°C)

Parameter	Symbol	Test Conditions	Min.	Typ.	Max.	Units
Continuous Operating Voltage	V _{DC}	---	---	---	5	V
Trigger Voltage	V _T	IEC61000-4-2 8KV contact discharge	---	300	---	V
Clamping Voltage	V _C	IEC61000-4-2 8KV contact discharge	---	15.5	---	V
Leakage Current	I _L	DC 5V shall be applied on component	---	---	10	nA
Capacitance	C _P	Measured at 10MHz	---	50	---	pF
ESD Pulse Withstand	Pulses	IEC61000-4-2 8KV contact discharge	1000	---	---	---

Notes:

1. Trigger and clamping voltage are measured per IEC 61000-4-2, 8KV contact discharge method.
2. After reliability tests such as high Temp storage, Temp cycles, continuous ESD strike etc, the maximum leakage current is less than 1uA.

Typical Device Capacitance VS. Frequency

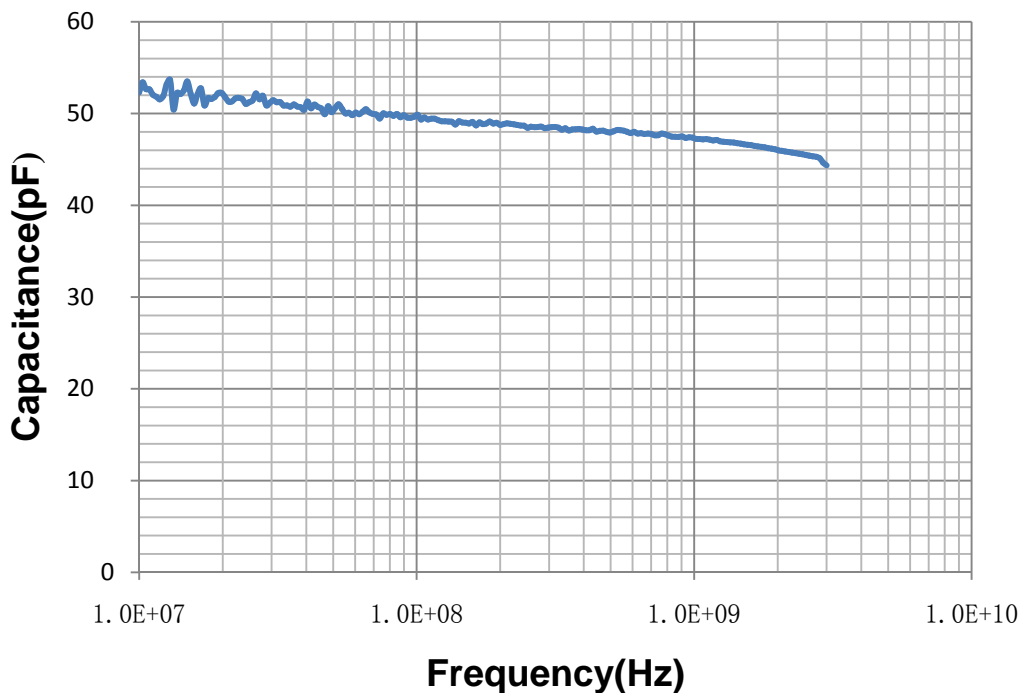

ESD Protection for HDMI

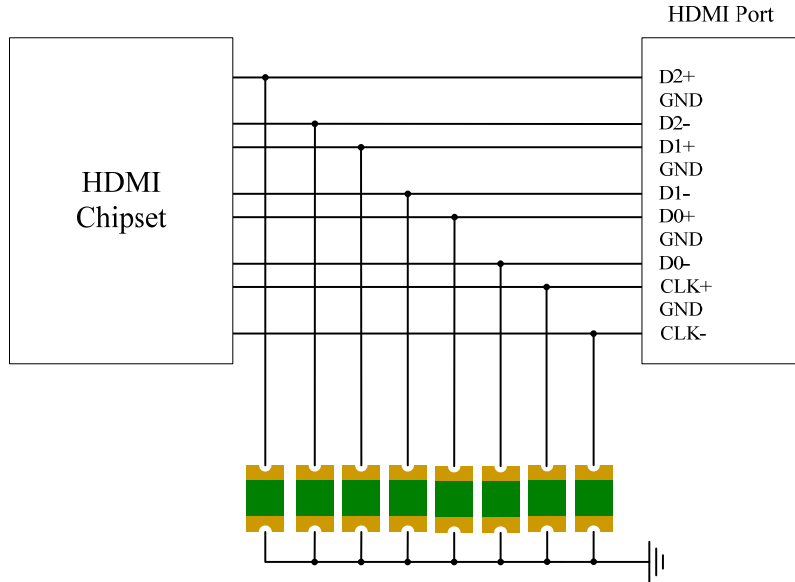

Package Dimension

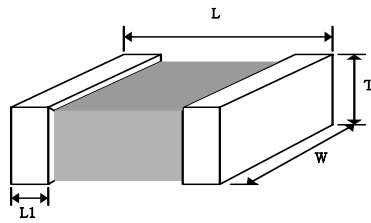

CODE	DIMENSION (mm)			
	L	W	T	L1
0402	1.0±0.05	0.5±0.05	0.5±0.05	0.2+ 0.15/-0.1

Taping Specification

1. Tape Dimension

Unit: Millimeters

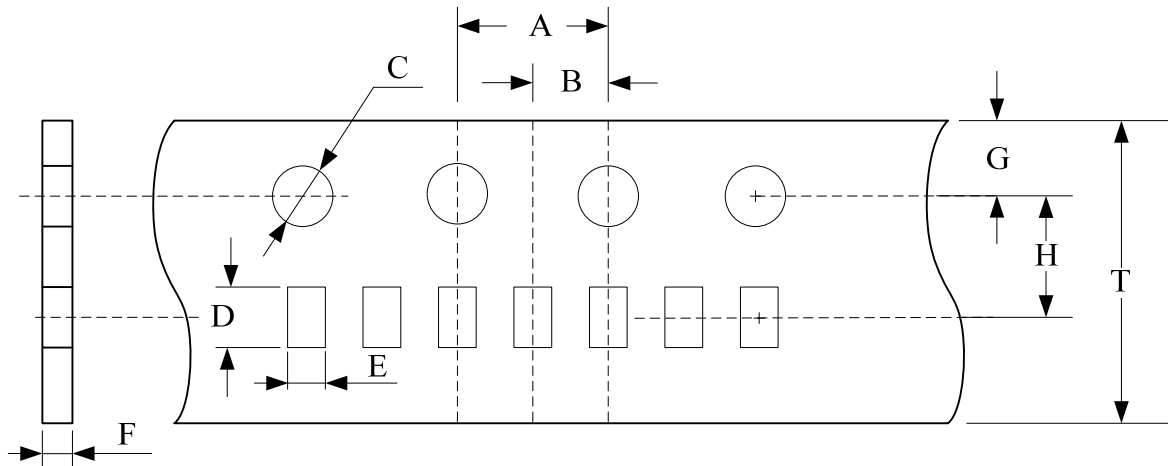

A	B	C	D	E	F	G	H	T
4.00±0.10	2.00±0.10	∅1.55±0.10	1.90±0.05	1.0±0.05	0.48±0.05	1.75±0.10	3.50±0.05	8.00±0.30

2. Reel Dimension

Unit: Millimeters

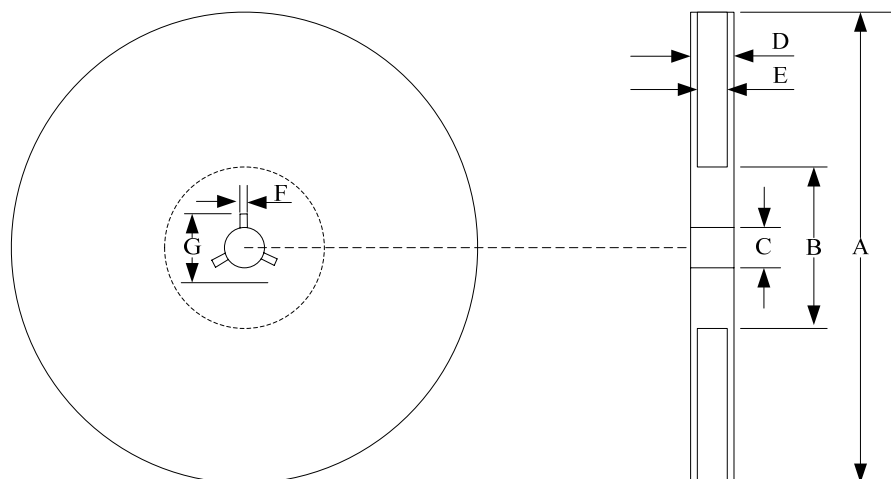

A	B min.	C	D	E	F	G
178.0 ±2.0	50.0	13.0±0.5	13.0±1.0	9.40±1.0	2.0 ±0.5	21.0±0.8

Soldering Parameters

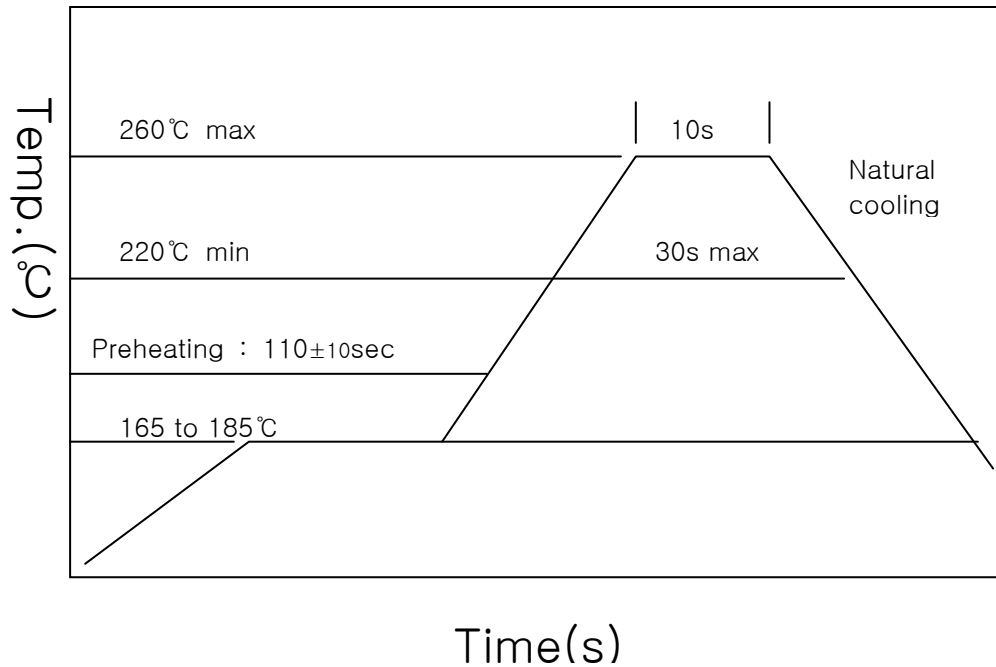

Land Pattern

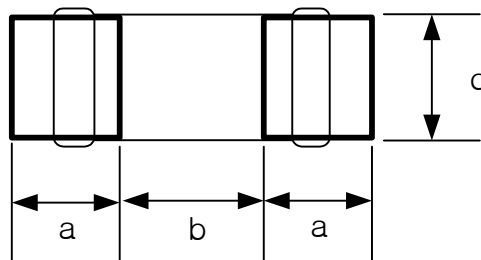

Size	a	b	c
0402	0.4~0.6	0.4~0.5	0.4~0.6

Leiditech Electronics are trademarks.

Information furnished is believed to be accurate and reliable. However, users should independently evaluate the suitability of and test each product selected for their own applications. Leiditech Electronics reserves the right to change or update, without notice, any information contained in this publication; to change, without notice, the design, construction, processing, or specification of any product; and to discontinue or limit production or distribution of any product. This publication supersedes and replaces all information previously supplied. Without expressed or written consent by an officer of Leiditech Electronics, Leiditech Electronics does not authorize the use of any of its products as components in nuclear facility applications, aerospace, or in critical life support devices or systems. Leiditech Electronics expressly disclaims all implied warranties regarding the information contained herein, including, but not limited to, any implied warranties of merchantability or fitness for a particular purpose. Leiditech Electronics' only obligations are those in the Leiditech Electronics Standard Terms and Conditions of Sale and in no case will Leiditech Electronics be liable for any incidental, indirect, or consequential damages.