

NCP5183, NCV5183

High Voltage High Current High and Low Side Driver

The NCP5183 is a High Voltage High Current Power MOSFET Driver providing two outputs for direct drive of 2 N-channel power MOSFETs arranged in a half-bridge (or any other high-side + low-side) configuration.

It uses the bootstrap technique to insure a proper drive of the High-side power switch. The driver works with 2 independent inputs to accommodate any topology (including half-bridge, asymmetrical half-bridge, active clamp and full-bridge...).

Features

- Automotive Qualified to AEC Q100
- Voltage Range: up to 600 V
- dV/dt Immunity ± 50 V/ns
- Gate Drive Supply Range from 9 V to 18 V
- Output Source / Sink Current Capability 4.3 A / 4.3 A
- 3.3 V and 5 V Input Logic Compatible
- Extended Allowable Negative Bridge Pin Voltage Swing to -10 V
 - ◆ Matched Propagation Delays between Both Channels
 - ◆ Propagation Delay 120 ns typically
 - ◆ Under V_{CC} LockOut (UVLO) for Both Channels
- Pin to Pin Compatible with Industry Standards
- These are Pb-free Devices

Typical Application

- Power Supplies for Telecom and Datacom
- Half-Bridge and Full-Bridge Converters
- Push-Pull Converters
- High Voltage Synchronous-Buck Converters
- Motor Controls
- Electric Power Steering
- Class-D Audio Amplifiers



ON Semiconductor®

www.onsemi.com



SOIC-8 NB
CASE 751-07

MARKING DIAGRAM

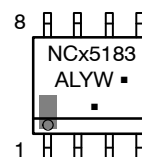

x = P or V
A = Assembly Location
L = Wafer Lot
Y = Year
W = Work Week
▪ = Pb-Free Package

(Note: Microdot may be in either location)

PIN CONNECTIONS

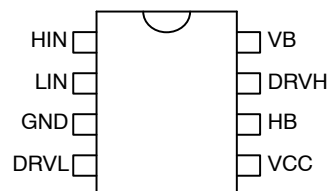

ORDERING INFORMATION

Device	Package	Shipping†
NCP5183DR2G	SOIC-8 (Pb-Free)	2500 / Tape & Reel
NCV5183DR2G	SOIC-8 (Pb-Free)	2500 / Tape & Reel

†For information on tape and reel specifications, including part orientation and tape sizes, please refer to our Tape and Reel Packaging Specification Brochure, BRD8011/D.

NCP5183, NCV5183

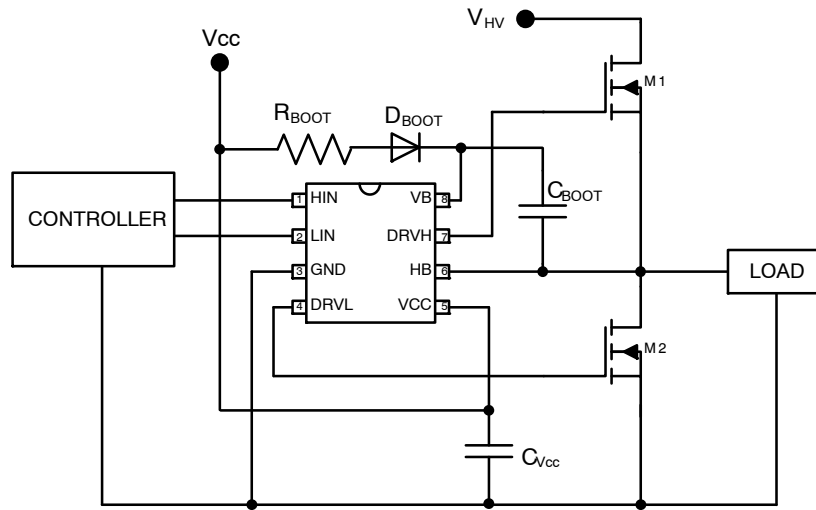

Figure 1. Application Schematic

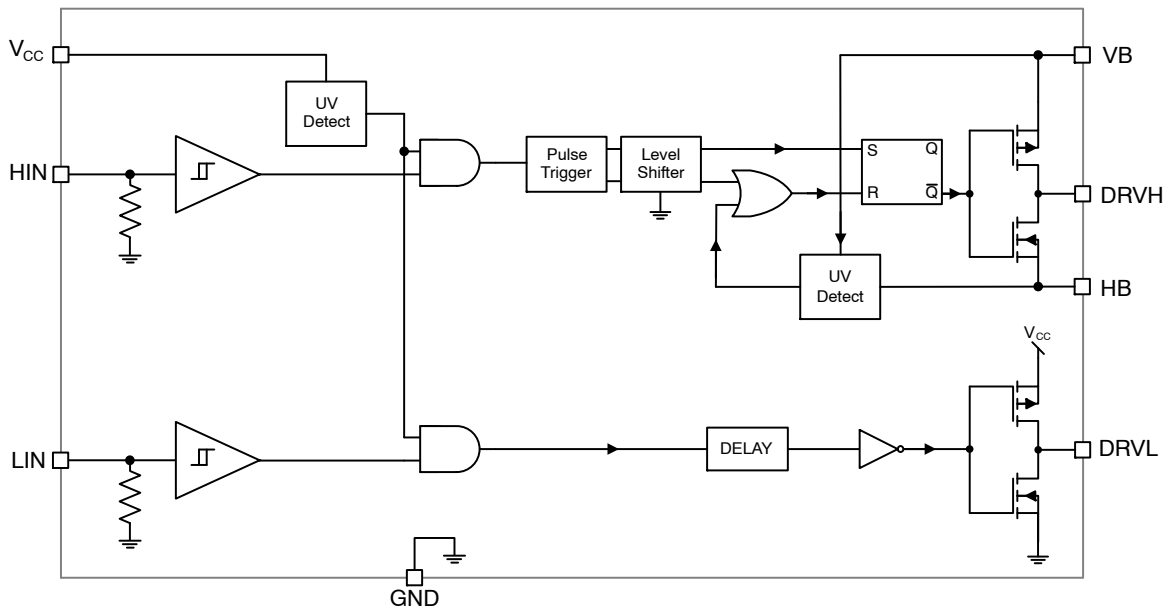

Figure 2. Simplified Block Diagram

Table 1. PIN FUNCTION DESCRIPTION

Pin No. (SOIC8)	Pin Name	Description
1	HIN	High Side Logic Input
2	LIN	Low Side Logic Input
3	GND	Ground
4	DRVL	Low Side Gate Drive Output
5	VCC	Main Power Supply
6	HB	Bootstrap Return or High Side Floating Supply Return
7	DRVH	High Side Gate Drive Output
8	VB	Bootstrap Power Supply

NCP5183, NCV5183

Table 2. ABSOLUTE MAXIMUM RATINGS

All voltages are referenced to GND pin

Rating	Symbol	Value	Units
Input Voltage Range	V_{CC}	-0.3 to 18	V
Input Voltage on LIN and HIN pins	V_{LIN}, V_{HIN}	-0.3 to 18	V
High Side Boot pin Voltage	V_B	(higher of $\{-0.3; V_{CC} - 1.5\}$) to 618	V
High Side Bridge pin Voltage	V_{HB}	$V_B - 18$ to $V_B + 0.3$	V
High Side Floating Voltage	$V_B - V_{HB}$	-0.3 to 18	V
High Side Output Voltage	V_{DRVH}	$V_{HB} - 0.3$ to $V_B + 0.3$	V
Low Side Output Voltage	V_{DRVL}	-0.3 to $V_{CC} + 0.3$	V
Allowable output slew rate	dV_{HB}/dt	50	V/ns
Maximum Operating Junction Temperature	$T_{J(max)}$	150	°C
Storage Temperature Range	TSTG	-55 to 150	°C
ESD Capability, Human Body Model (Note 1)	ESDHBM	3	kV
ESD Capability, Charged Device Model (Note 1)	ESDCDM	1	kV
Lead Temperature Soldering Reflow (SMD Styles Only), Pb-Free Versions (Note 2)	T_{SLD}	260	°C

Stresses exceeding those listed in the Maximum Ratings table may damage the device. If any of these limits are exceeded, device functionality should not be assumed, damage may occur and reliability may be affected.

- This device series incorporates ESD protection and is tested by the following methods:
 ESD Human Body Model tested per AEC-Q100-002 (EIA/JESD22-A114)
 ESD Charged Device Model tested per AEC-Q100-11 (EIA/JESD22-C101E)
 Latchup Current Maximum Rating: ≤ 150 mA per JEDEC standard: JESD78
- For information, please refer to our Soldering and Mounting Techniques Reference Manual, SOLDERRM/D

Table 3. THERMAL CHARACTERISTICS

Rating	Symbol	Value	Units
Thermal Characteristics SO8 (Note 3) Thermal Resistance, Junction-to-Air (Note 4)	$R_{\theta JA}$	183	°C/W

- Refer to ELECTRICAL CHARACTERISTICS and APPLICATION INFORMATION for Safe Operating Area.
- Values based on copper area of 645 mm² (or 1 in²) of 1 oz copper thickness and FR4 PCB substrate.

Table 4. RECOMMENDED OPERATING CONDITIONS (Note 5)

All voltages are referenced to GND pin

Rating	Symbol	Min	Max	Units
Input Voltage Range	V_{CC}	10	17	V
High Side Floating Voltage	$V_B - V_{HB}$	10	17	V
High Side Bridge pin Voltage	V_{HB}	-1	580	V
High Side Output Voltage	V_{DRVH}	V_{HB}	V_B	V
Low Side Output Voltage	V_{DRVL}	GND	V_{CC}	V
Input Voltage on LIN and HIN pins	V_{LIN}, V_{HIN}	GND	$V_{CC} - 2$	V
Operating Junction Temperature Range	T_J	-40	125	°C

- Refer to ELECTRICAL CHARACTERISTICS and APPLICATION INFORMATION for Safe Operating Area.

NCP5183, NCV5183

Table 5. ELECTRICAL CHARACTERISTICS

$-40^{\circ}\text{C} \leq T_J \leq 125^{\circ}\text{C}$, $V_{CC} = V_B = 15\text{ V}$, $V_{HB} = \text{GND}$, outputs are not loaded, all voltages are referenced to GND; unless otherwise noted. Typical values are at $T_J = +25^{\circ}\text{C}$. (Notes 6, 7)

Parameter	Test Conditions	Symbol	Min	Typ	Max	Units
Supply Section						
V_{CC} UVLO	V_{CC} rising	V_{CCon}	7.8	8.8	9.8	V
	V_{CC} falling	V_{CCoff}	7.2	8.3	9.1	V
	V_{CC} hysteresis	V_{CChyst}		0.5		V
V_B UVLO	V_B rising	V_{Bon}	7.8	8.8	9.8	V
	V_B falling	V_{Boff}	7.2	8.3	9.1	V
	V_B hysteresis	V_{Bhyst}		0.5		V
V_{CC} pin operating current	$f = 20\text{ kHz}$, $C_L = 1\text{ nF}$	I_{CC1}		520	700	μA
V_B pin operating current	$f = 20\text{ kHz}$, $C_L = 1\text{ nF}$	I_{B1}		700	800	μA
V_{CC} pin quiescent current	$V_{LIN} = V_{HIN} = 0\text{ V}$	I_{CC2}		95	160	μA
V_B pin quiescent current	$V_{LIN} = V_{HIN} = 0\text{ V}$	I_{B2}		65	100	μA
V_B to GND quiescent current	$V_B = V_{HB} = 600\text{ V}$	I_{HSleak}			50	μA

Input Section

Logic High Input Voltage		V_{INH}	2.5			V
Logic Low Input Voltage		V_{INL}			1.2	V
Logic High Input Current	$V_{xIN} = 5\text{ V}$	I_{xIN+}		25	50	μA
Logic Low Input Current	$V_{xIN} = 0\text{ V}$	I_{xIN-}			1	μA
Input Pull Down Resistance	$V_{xIN} = 5\text{ V}$	R_{xIN}	100	250		$\text{k}\Omega$

Output Section

Low Level Output Voltage	$I_{DRV L} = 0\text{ A}$	$V_{DRV L L}$			35	mV
Low Level Output Voltage (HS Driver)	$I_{DRV H} = 0\text{ A}$	$V_{DRV H L}$			35	mV
High Level Output Voltage	$I_{DRV L} = 0\text{ A}$, $V_{DRV L H} = V_{CC} - V_{DRV L}$	$V_{DRV L H}$			35	mV
High Level Output Voltage (HS Driver)	$I_{DRV H} = 0\text{ A}$, $V_{DRV H H} = V_B - V_{DRV H}$	$V_{DRV H H}$			35	mV
Output Positive Peak current	$V_{DRV L} = 0\text{ V}$, $\text{PW} = 10\text{ }\mu\text{s}$	$I_{DRV L H}$		4.3		A
Output Negative Peak current	$V_{DRV L} = 15\text{ V}$, $\text{PW} = 10\text{ }\mu\text{s}$	$I_{DRV L L}$		4.3		A
Output Positive Peak current (HS Driver)	$V_{DRV H} = 0\text{ V}$, $\text{PW} = 10\text{ }\mu\text{s}$	$I_{DRV H H}$		4.3		A
Output Negative Peak current (HS Driver)	$V_{DRV H} = 15\text{ V}$, $\text{PW} = 10\text{ }\mu\text{s}$	$I_{DRV H L}$		4.3		A
Output Resistance		R_{OH}		1.7		Ω
Output Resistance		R_{OL}		1.1		Ω

Dynamic Section

Turn On Propagation Delay		t_{ON}		120	200	ns
Turn Off Propagation Delay		t_{OFF}		120	200	ns
Delay Matching	Pulse width = $1\text{ }\mu\text{s}$	t_{MT}		0	50	ns
Minimum Positive Pulse Width	$V_{xIN} = 0\text{ V}$ to 5 V	t_{minH}			150	ns
Minimum Negative Pulse Width	$V_{xIN} = 5\text{ V}$ to 0 V	t_{minL}			100	ns

6. Refer to ABSOLUTE MAXIMUM RATINGS and APPLICATION INFORMATION for Safe Operating Area

7. Performance guaranteed over the indicated operating temperature range by design and/or characterization tested at $T_J = T_A = 25^{\circ}\text{C}$. Low duty cycle pulse techniques are used during testing to maintain the junction temperature as close to ambient as possible

NCP5183, NCV5183

Table 5. ELECTRICAL CHARACTERISTICS

$-40^{\circ}\text{C} \leq T_J \leq 125^{\circ}\text{C}$, $V_{CC} = V_B = 15\text{ V}$, $V_{HB} = \text{GND}$, outputs are not loaded, all voltages are referenced to GND; unless otherwise noted. Typical values are at $T_J = +25^{\circ}\text{C}$. (Notes 6, 7)

Parameter	Test Conditions	Symbol	Min	Typ	Max	Units
Switching Parameters						
Output Voltage Rise Time	10% to 90%, $C_L = 1\text{ nF}$	t_r		12	40	ns
Output Voltage Fall Time	90% to 10%, $C_L = 1\text{ nF}$	t_f		12	40	ns
Negative HB pin Voltage	$PW \leq t_{ON}$, $V_{CC} = V_B = 10\text{ V}$	V_{HBneg}		-8	-7	V

6. Refer to ABSOLUTE MAXIMUM RATINGS and APPLICATION INFORMATION for Safe Operating Area

7. Performance guaranteed over the indicated operating temperature range by design and/or characterization tested at $T_J = T_A = 25^{\circ}\text{C}$. Low duty cycle pulse techniques are used during testing to maintain the junction temperature as close to ambient as possible

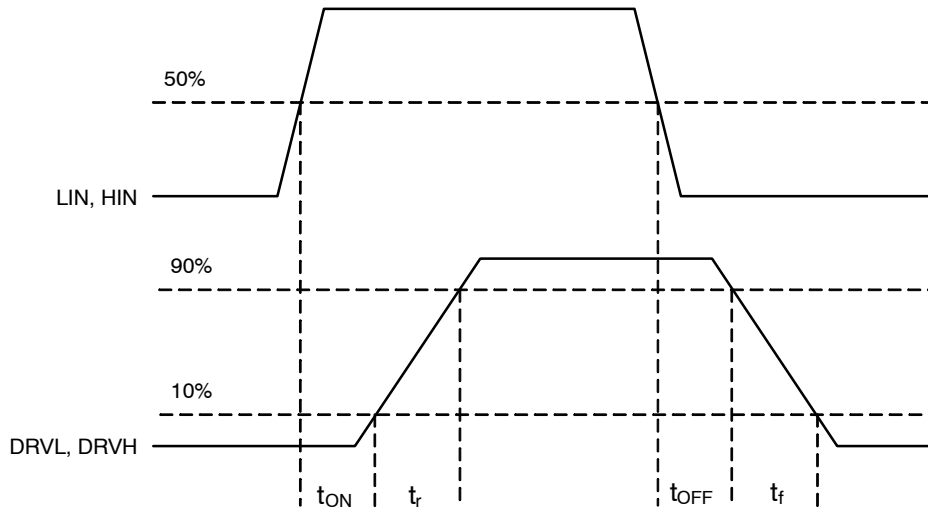

Figure 3. Propagation Delay, Rise Time and Fall Time Timing

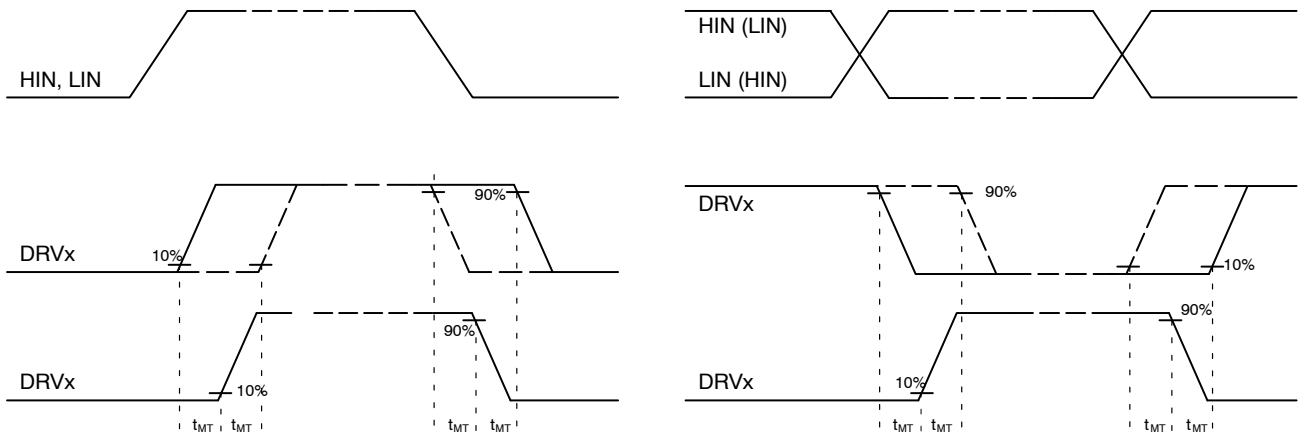

Figure 4. Delay Matching

NCP5183, NCV5183

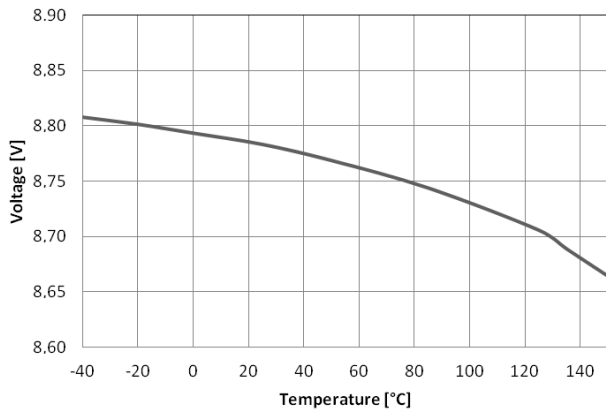

Figure 5. V_{CCOn} vs. Temperature

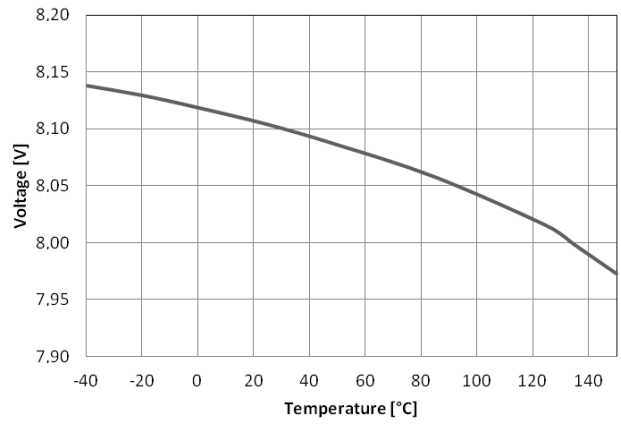

Figure 6. V_{CCOff} vs. Temperature

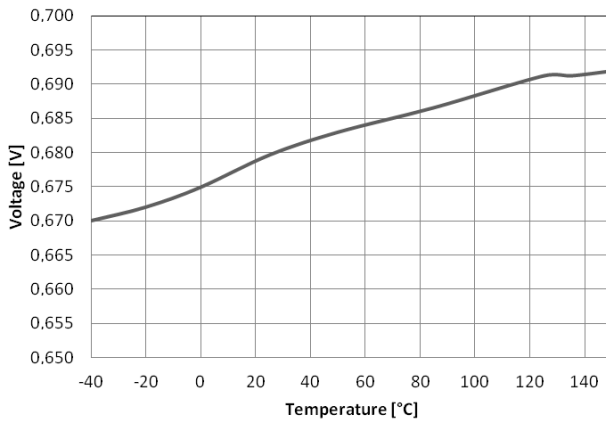

Figure 7. V_{CCUVLOHYS} vs. Temperature

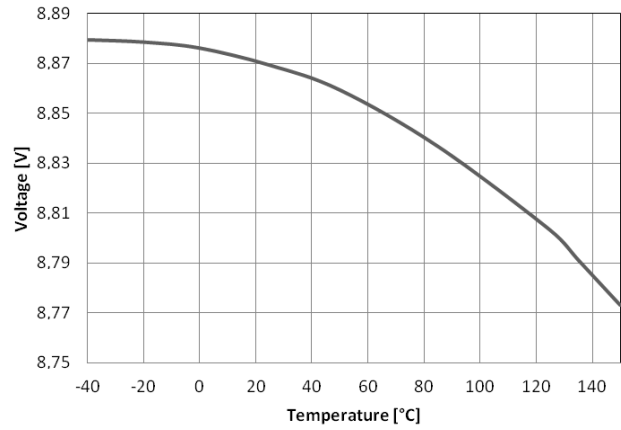

Figure 8. V_{Bon} vs. Temperature

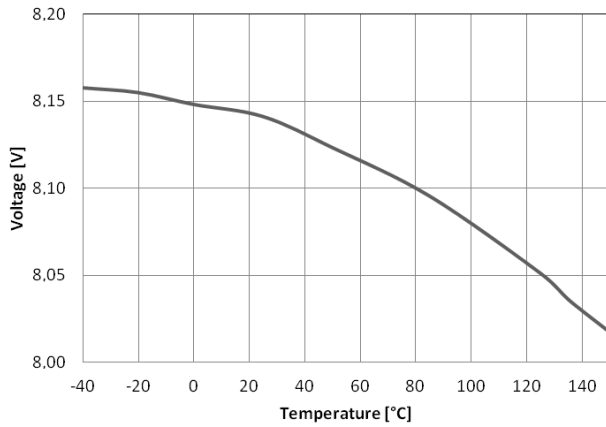

Figure 9. V_{Boff} vs. Temperature

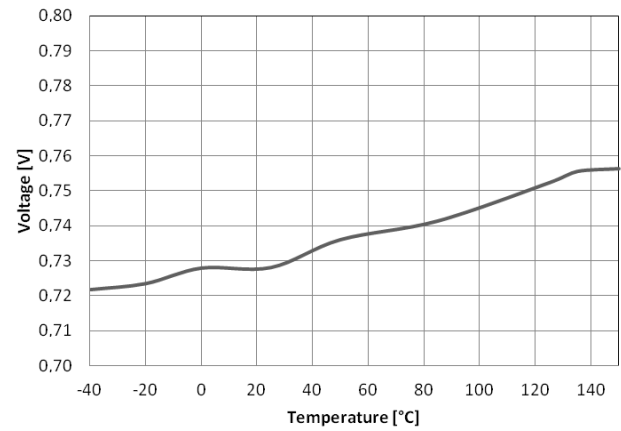

Figure 10. V_{Bhyst} vs. Temperature

NCP5183, NCV5183

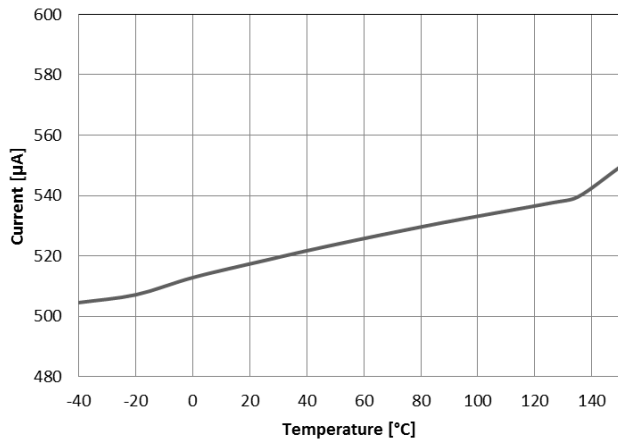

Figure 11. I_{CC1} vs. Temperature

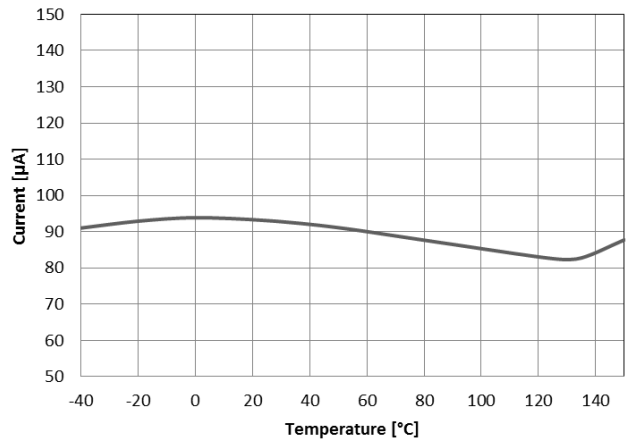

Figure 12. I_{CC2} vs. Temperature

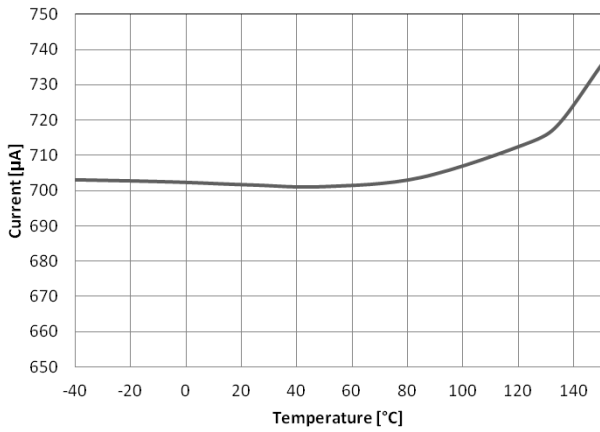

Figure 13. I_{B1} vs. Temperature

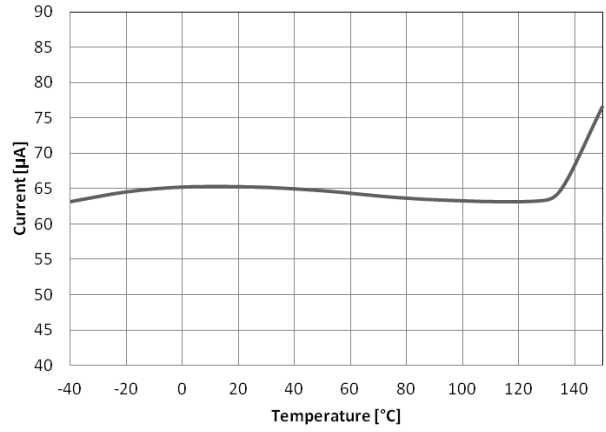

Figure 14. I_{B2} vs. Temperature

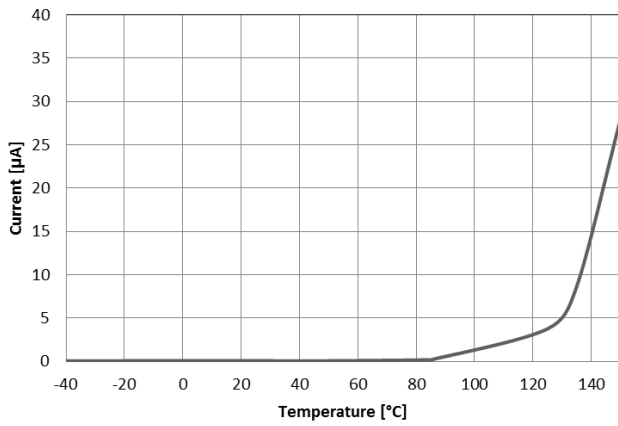

Figure 15. I_{HSleak} vs. Temperature

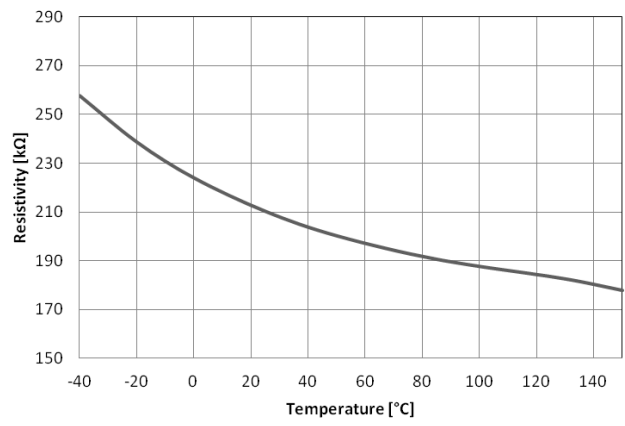

Figure 16. R_{IN} vs. Temperature

NCP5183, NCV5183

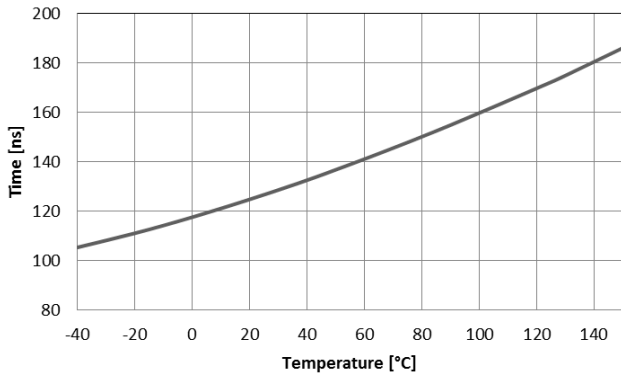

Figure 17. t_{ON} vs. Temperature

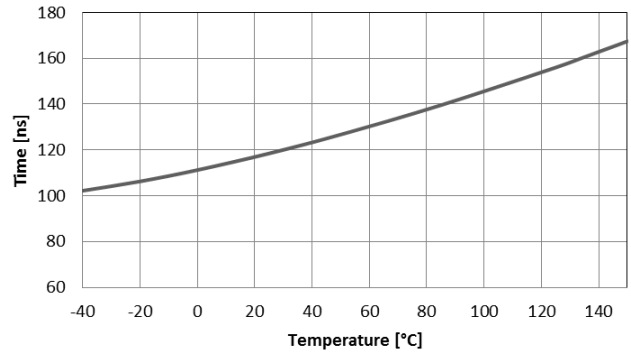

Figure 18. t_{OFF} vs. Temperature

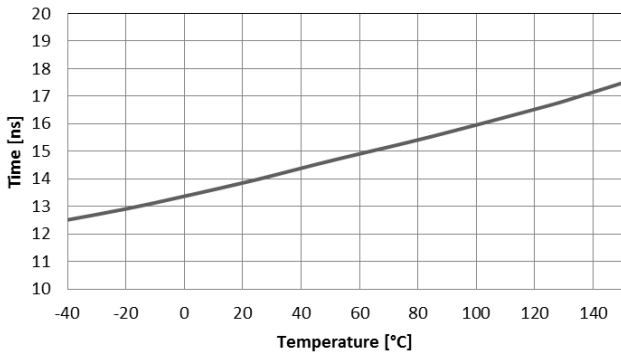

Figure 19. t_r vs. Temperature

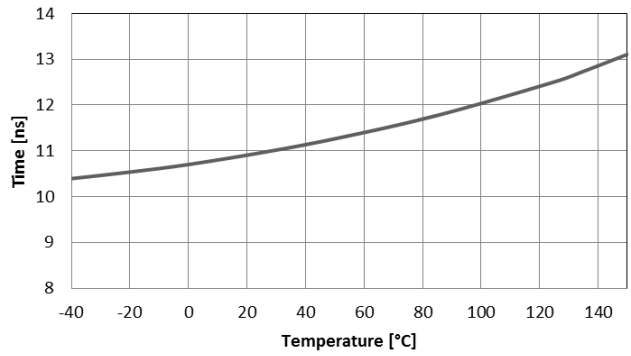

Figure 20. t_f vs. Temperature

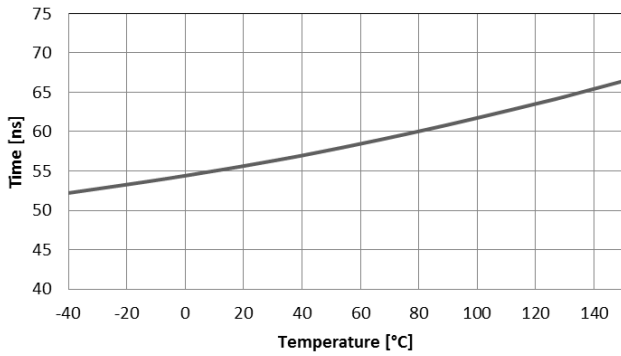

Figure 21. t_r for 10 nF Load vs. Temperature

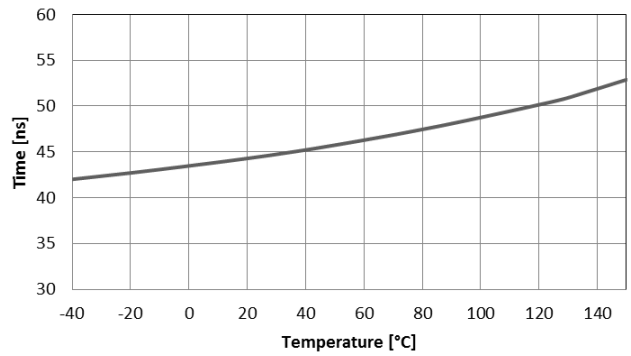

Figure 22. t_f for 10 nF Load vs. Temperature

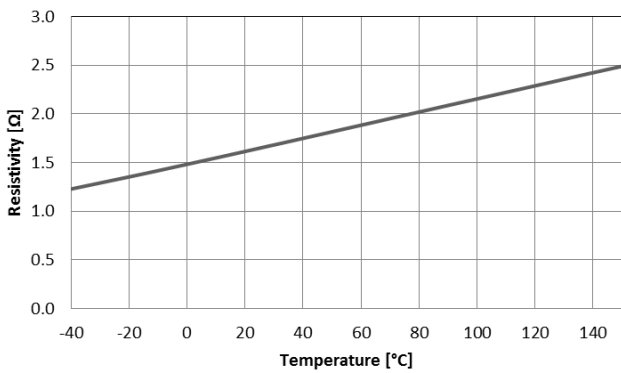

Figure 23. R_{ON} vs. Temperature

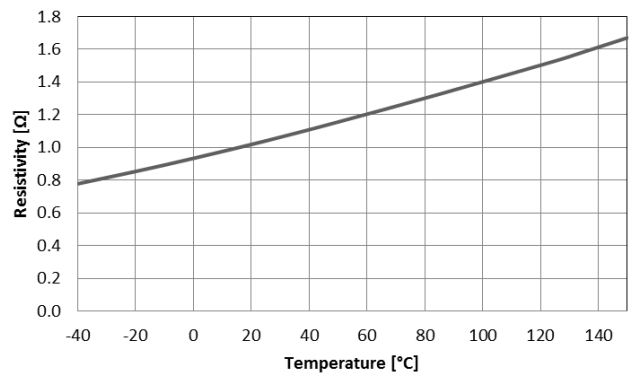

Figure 24. R_{OL} vs. Temperature

NCP5183, NCV5183

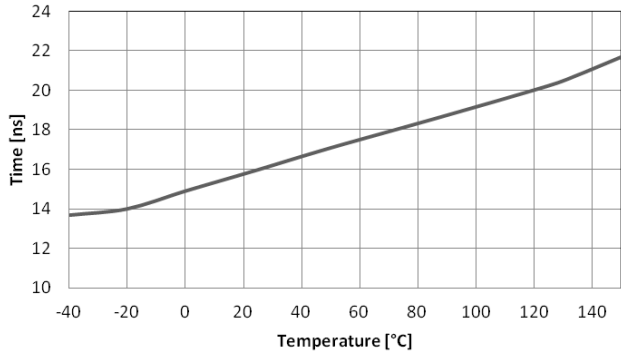

Figure 25. t_{MT} vs. Temperature

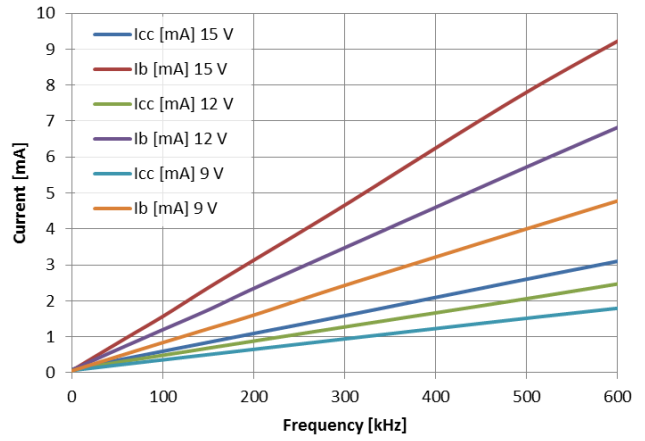
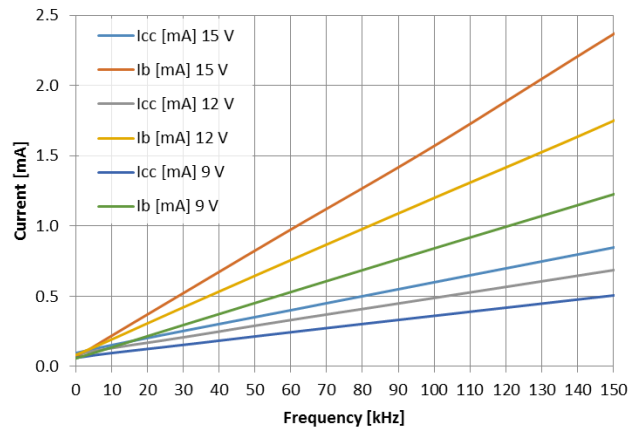

Figure 26. I_{CC} and I_B Current Consumption vs. Frequency



Detail of I_{CC} and I_B Consumption to 150 kHz

MOSFET Turn On and Turn Off Current Path

A capacitor connected from VCC (VB) to GND (HB) terminal is source of energy for charging the gate terminal of an external MOSFET(s). For better understanding of this process see Figure 27 (all voltages are related to GND (HB) pin). When there is a request from internal logic to turn on the external MOSFET, then the Q_{source} is turned on. The current starts to flow from C_{VCC} (C_{boot}), through Q_{source}, gate resistor R_g to the gate terminal of the external MOSFET (depicted by red line). The current loop is closed from external MOSFET source terminal back to the C_{VCC} (C_{boot}) capacitor. After a while the C_{GS} capacitance is fully charged so no current flows this path. When the external MOSFET going to be turned off, the internal Q_{source} is turned off first

and after a short dead time Q_{sink} is turned on. Then C_{VCC} (C_{boot}) is not a source any more, the source of energy became the C_{GS} (and all capacitance connected to this terminal, like Muller capacitance). Now the current flows from gate terminal, through R_g resistor and Q_{sink} back to the MOSFET (depicted by blue line). In both cases (charging and discharging external MOSFET) there are several parasitic inductances in the path. All of them play a role during switching. In Figure 27 an influence of the inductances in some places is showed. On VCC (VB) pin a drop during turn on and turn off is observed. If too long an UVLO protection can be triggered and the driver can be turned off subsequently, which result in improper operation of the application.

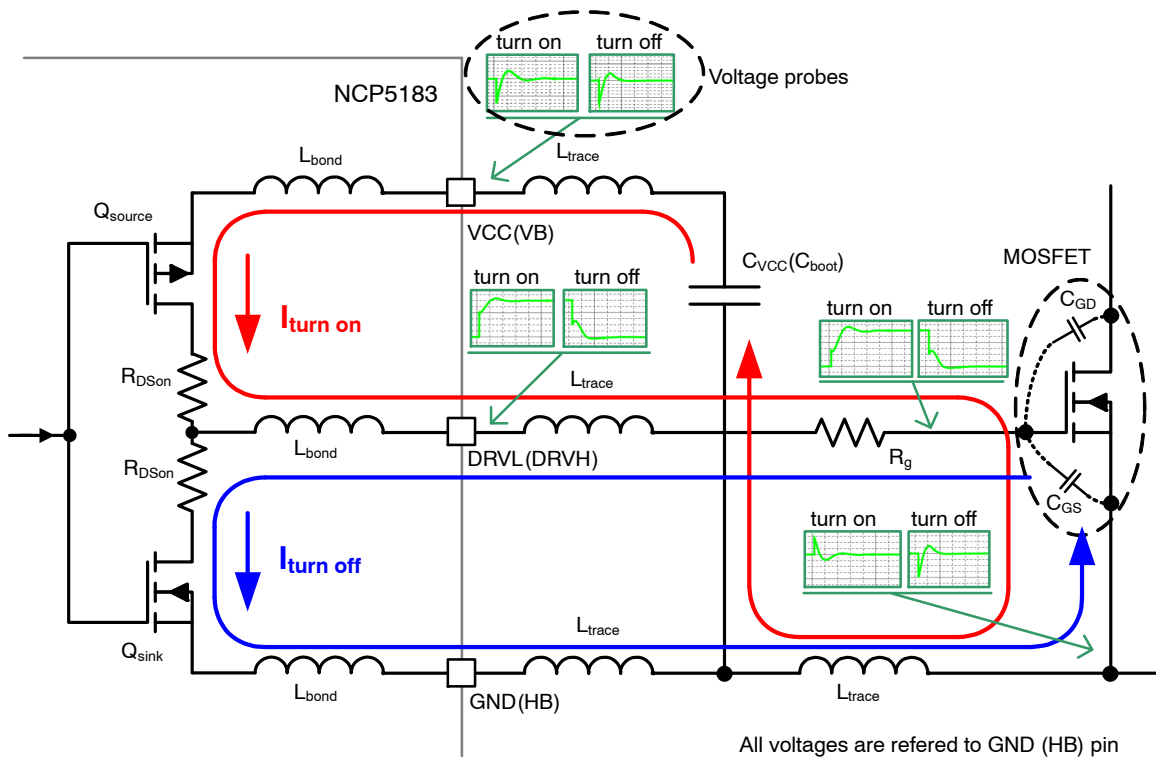

Figure 27. Equivalent Circuit of Power Switch Driver

NCP5183, NCV5183

Layout Recommendation

The NCP5183 is high speed, high current (sink/source 4.3 A/4.3 A) driver suitable for high power application. To avoid any damage and/or malfunction during switching (and/or during transients, overloads, shorts etc.) it is very important to avoid a high parasitic inductances in high current paths (see “MOSFET turn on and turn off current path” section). It is recommended to fulfill some rules in layout. One of a possible layout for the IC is depicted in Figure 28.

- Keep loop HB_pin – GND_pin – Q_LO as small as possible. This loop (parasitic inductance) has potential to increase negative spike on HB pin which can cause of malfunction or damage of HB driver. The negative voltage presented on HB pin is added to $V_{CC} - V_f$ voltage so $V_{C_{boot}}$ is increased. In extreme case the C_{boot} voltage can be so high it will reach maximum rating value which can lead to device damage.
- Keep loop VDD_pin – GND_pin – C_{VCC} as small as possible. The IC featured high current capability driver.

Any parasitic inductance in this path will result in slow Q_LO turn on and voltage drop on VCC pin which can result in UVLO activation.

- Keep loop VB_pin – HB_pin – C_{boot} as small as possible. The IC featured high current capability driver. Any parasitic inductance in this path will result in slow Q_HI turn on and voltage drop on VB pin which can result in UVLO activation.
- Do not let high current flow through trace between GND_pin and C_{VCC} even a small parasitic inductance here will create high voltage drop if high current flows through this path. This voltage is added or subtracted from HIN and LIN signal, which results in incorrect thresholds or device damaging.
- Keep loops DRVL_pin – Q_LO – GND_pin and DRVH_pin – Q_HI – HB_pin as small as possible. A high parasitic inductance in these paths will result in slow MOSFET switching and undesired resonance on gate terminal.

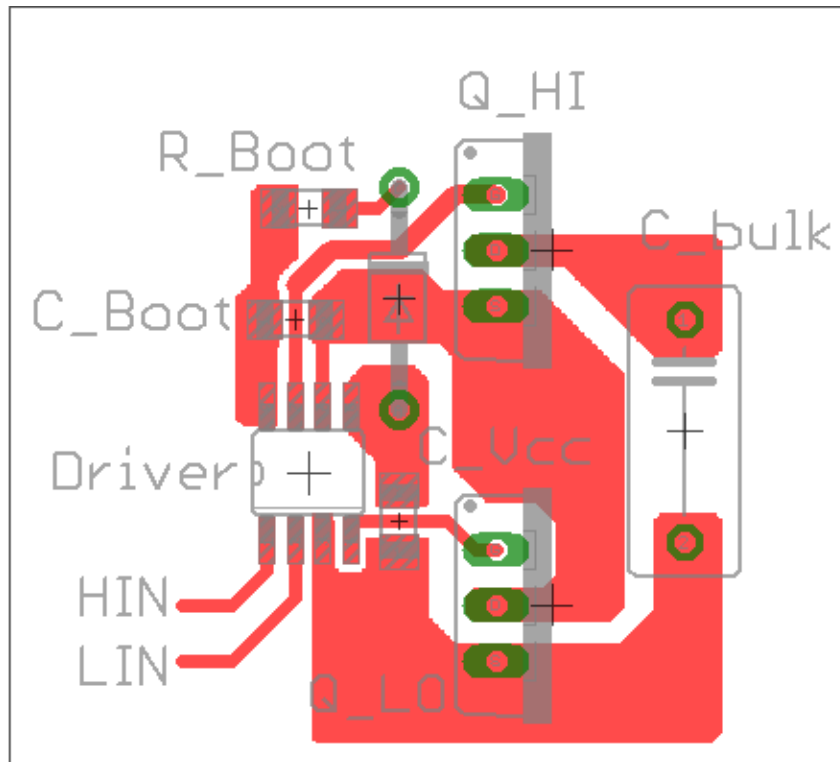

Figure 28. Recommended Layout

C_{boot} Capacitor Value Calculation

The device featured two independent 4.3 A sink and source drivers. The low side driver (DRV_L) supplies a MOSFET whose source is connected to ground. The driver is powered from V_{CC} line. The high side driver (DRV_H) supplies a MOSFET whose source is floating from GND to bulk voltage. The floating driver is powered from C_{boot} capacitor. The capacitor is charged only when HB pin is pulled to GND (by inductance or the low side MOSFET when turned on). If too small C_{boot} capacitor is used the high side UVLO protection can disable the high side driver which leads to improper switching.

Expected voltage on C_{boot} is depicted in Figure 29. The curves are valid for ZVS (Zero Voltage Switching) observed in LLC applications. For hard switch the curves are slightly different, but from charge on C_{boot} point of view more

favorable. Under the hard switch conditions the energy to charge Q_g (from zero voltage to V_{th} of the MOSFET) is taken from V_{CC} capacitor (through an external boot strap diode) so the voltage drop on C_{boot} is smaller. For the calculation of C_{boot} value the ZVS conditions are taken account.

The switching cycle is divided into two parts, the charging (t_{charge}) and the discharging (t_{discharge}) of the C_{boot} capacitor. The discharging can be divided even more to discharging by floating driver current consumption I_{B2} (t_{dsIb}) and to discharging by transferring energy from C_{boot} to gate terminal of the MOSFET (t_{dsQm}). Discharging by I_{B2} becoming more dominant when driver runs at lower frequencies and/or during skip mode operation. To calculate C_{boot} value, follow these steps:

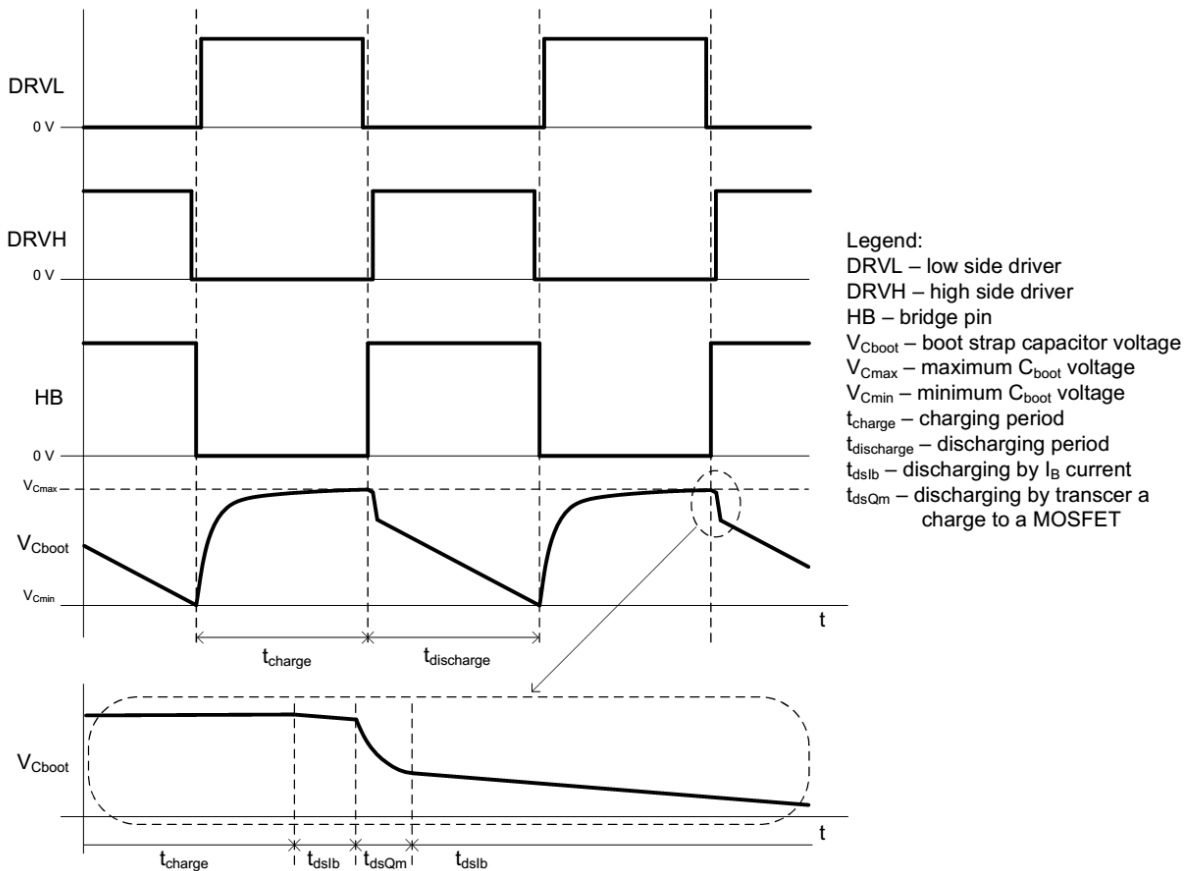

Figure 29. Boot Strap Capacitor Charging Principle

1. For example, let's have a MOSFET with Q_g = 30 nC, V_{DD} = 15 V.
2. Charge stored in C_{boot} necessary to cover the period the C_{boot} is not supplied from V_{CC} line (which is basically the period the high side MOSFET is turned on). Let's say the application is switching at 100 kHz, 50% duty cycle, which means the upper MOSFET is conductive for 5 μs. It means the C_{boot} is discharged by I_{B2} current

(65 μA typ) for 5 μs, so the charge consumed by floating driver is:

$$Q_b = I_{B2} \cdot t_{discharge} = 65\mu \cdot 5\mu = 325 \text{ pC} \quad (\text{eq. 1})$$

3. Total charge loss during one switching cycle is sum of charge to supply the high side driver and MOSFET's gate charge:

$$Q_{tot} = Q_g + Q_b = 30\text{n} + 325\text{p} = 30.3 \text{ nC} \quad (\text{eq. 2})$$

4. Let's determine acceptable voltage ripple on C_{boot} to 1% of nominal value, which is 150 mV. To cover charge losses from eq. 2

$$C_{boot} = \frac{Q_{tot}}{V_{ripple}} = \frac{30.3n}{0.15} = 202 \text{ nF} \quad (\text{eq. 3})$$

It is recommended to increase the value as consumption and gate charge are temperature and voltage dependent, so let's choose a capacitor 330 nF in this case.

R_{boot} Resistor Value Calculation

To keep the application running properly, it is necessary to charge the C_{boot} again. This is done by external diode from V_{CC} line to VB pin. In serial with the diode a resistor is placed to reduce the current peaks from V_{CC} line. The resistor value selection is critical for proper function of the high side driver. If too small high current peaks are drawn from V_{CC} line, if too high the capacitor will not be charged to appropriate level and the high side driver can be disabled by internal UVLO protection.

First of all keep in mind the capacitor is charged through the external boot strap diode, so it can be charged to a maximum voltage level of $V_{CC} - V_f$. The resistor value is calculated using this equation:

$$R_{boot} = \frac{t_{charge}}{C_{boot} \cdot \ln\left(\frac{V_{max} - V_{Cmin}}{V_{max} - V_{Cmax}}\right)} = \frac{5\mu}{330n \cdot \ln\left(\frac{14.4 - 14.2}{14.4 - 14.35}\right)} \cong 11 \Omega \quad (\text{eq. 4})$$

Where:

t_{charge} – time period the C_{boot} is being charged, usually the period the low side MOSFET is turned on

C_{boot} – boot strap capacitor value

V_{max} – maximum voltage the C_{boot} capacitor can be theoretically charged to. Usually the $V_{CC} - V_f$. The V_f is forward voltage of used diode.

V_{Cmin} – the voltage level the capacitor is charged from

V_{Cmax} – the voltage level the capacitor is charged to. It is necessary to determine the target voltage for charging, because in theory, when a capacitor is charged from a voltage source through a resistor, the capacitor can never reach the voltage of the source. In this particular case a 50 mV difference (between the voltage behind the diode and V_{Cmax}) is used.

The resistor value obtained from eq. 4 does not count with the quiescent current I_{B2} of the high side driver. This current will create another voltage drop of:

$$V_{IB2_drop} = R_{boot} \cdot I_{B2} = 11 \cdot 65\mu \cong 0.7 \text{ mV} \quad (\text{eq. 5})$$

The current consumed by high side driver will be higher, because the I_{B2} is valid when the device is not switching. While switching, losses by charging and discharging internal transistors as well as the level shifters will be added. This current will increase with frequency.

The additional 0.7 mV drop will be added to V_{Cmax} value. The additional 0.7 mV drop can be either accepted or the

R_{boot} value can be recalculated to eliminate this additional drop.

The resistor R_{boot} calculated in eq. 4 is valid under steady state conditions. During start and/or skip operation the starting point voltage value is different (lower) and it takes more time to charge the boot strap capacitor. More over it is not counted with temperature and voltage variability during normal operation or the dynamic resistance of the boot strap diode (approximately 0.34 Ω for MURA160). From these reasons the resistor value should be decreased especially with respect to skip operation.

Boot strap resistor losses calculation.

$$P_{Rboot} \cong Q_{tot} \cdot V_{Cmax} \cdot f = 30.3n \cdot 14.4 \cdot 100k \cong 43.6 \text{ mW} \quad (\text{eq. 6})$$

Boot strap diode losses calculation.

$$P_{Dboot} \cong Q_{tot} \cdot V_f \cdot f = 30.3n \cdot 0.6 \cdot 100k \cong 1.8 \text{ mW} \quad (\text{eq. 7})$$

Please keep in mind the value is temperature and voltage dependent. Especially C_{boot} voltage can be higher than calculated value. See "Layout recommendation" section for more details.

Total Power Dissipation

The NCP5183 is suitable to drive high input capacitance MOSFET, from this reason it is equipped with high current capability drivers. Power dissipation on the die, especially at high frequencies can be limiting factor for using this driver. It is important to not exceed maximum junction temperature (listed in absolute maximum ratings table) in any cases. To calculate approximate power losses follow these steps:

1. Power loss of device (except drivers) while switching at appropriate frequency (see Figure 26) is equal to

$$P_{logic} = P_{HS} + P_{LS} = (V_{boot} \cdot I_{B2SW}) + (V_{CC} \cdot I_{CC2SW}) = (14.4 \cdot 1.6m) + (15 \cdot 0.6m) \cong 32.1 \text{ mW} \quad (\text{eq. 8})$$

2. Power loss of drivers

$$P_{drivers} = ((Q_g \cdot V_{boot}) + (Q_g \cdot V_{CC})) \cdot f = ((30n \cdot 14.4) + (30n \cdot 15)) \cdot 100k \cong 88 \text{ mW} \quad (\text{eq. 9})$$

3. Total power losses

$$P_{total} = P_{logic} + P_{drivers} = 32.1m + 88m \cong 120 \text{ mW} \quad (\text{eq. 10})$$

4. Junction temperature increase for calculated power loss

$$t_J = R_{tJa} \cdot P_{total} = 183 \cdot 0.12 \cong 22 \text{ K} \quad (\text{eq. 11})$$

The temperature calculated in eq. 11 is the value which has to be added to ambient temperature. In case the ambient temperature is 30°C, the junction temperature will be 52°C.

MECHANICAL CASE OUTLINE PACKAGE DIMENSIONS

ON Semiconductor®



SCALE 1:1

SOIC-8 NB
CASE 751-07
ISSUE AK

DATE 16 FEB 2011



- NOTES:
1. DIMENSIONING AND TOLERANCING PER ANSI Y14.5M, 1982.
 2. CONTROLLING DIMENSION: MILLIMETER.
 3. DIMENSION A AND B DO NOT INCLUDE MOLD PROTRUSION.
 4. MAXIMUM MOLD PROTRUSION 0.15 (0.006) PER SIDE.
 5. DIMENSION D DOES NOT INCLUDE DAMBAR PROTRUSION. ALLOWABLE DAMBAR PROTRUSION SHALL BE 0.127 (0.005) TOTAL IN EXCESS OF THE D DIMENSION AT MAXIMUM MATERIAL CONDITION.
 6. 751-01 THRU 751-06 ARE OBSOLETE. NEW STANDARD IS 751-07.

DIM	MILLIMETERS		INCHES	
	MIN	MAX	MIN	MAX
A	4.80	5.00	0.189	0.197
B	3.80	4.00	0.150	0.157
C	1.35	1.75	0.053	0.069
D	0.33	0.51	0.013	0.020
G	1.27 BSC		0.050 BSC	
H	0.10	0.25	0.004	0.010
J	0.19	0.25	0.007	0.010
K	0.40	1.27	0.016	0.050
M	0°	8°	0°	8°
N	0.25	0.50	0.010	0.020
S	5.80	6.20	0.228	0.244

GENERIC MARKING DIAGRAM*

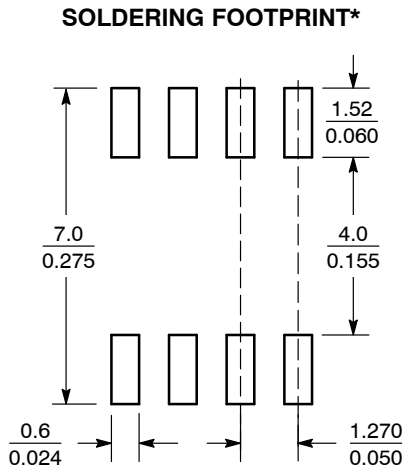

SCALE 6:1 ($\frac{\text{mm}}{\text{inches}}$)



XXXXXX = Specific Device Code
A = Assembly Location
L = Wafer Lot
Y = Year
W = Work Week
■ = Pb-Free Package

XXXXXX = Specific Device Code
A = Assembly Location
Y = Year
WW = Work Week
■ = Pb-Free Package

*This information is generic. Please refer to device data sheet for actual part marking. Pb-Free indicator, "G" or microdot "•", may or may not be present. Some products may not follow the Generic Marking.

*For additional information on our Pb-Free strategy and soldering details, please download the ON Semiconductor Soldering and Mounting Techniques Reference Manual, SOLDERRM/D.

STYLES ON PAGE 2

DOCUMENT NUMBER:	98ASB42564B	Electronic versions are uncontrolled except when accessed directly from the Document Repository. Printed versions are uncontrolled except when stamped "CONTROLLED COPY" in red.
DESCRIPTION:	SOIC-8 NB	PAGE 1 OF 2

ON Semiconductor and ON are trademarks of Semiconductor Components Industries, LLC dba ON Semiconductor or its subsidiaries in the United States and/or other countries. ON Semiconductor reserves the right to make changes without further notice to any products herein. ON Semiconductor makes no warranty, representation or guarantee regarding the suitability of its products for any particular purpose, nor does ON Semiconductor assume any liability arising out of the application or use of any product or circuit, and specifically disclaims any and all liability, including without limitation special, consequential or incidental damages. ON Semiconductor does not convey any license under its patent rights nor the rights of others.

SOIC-8 NB
CASE 751-07
ISSUE AK

DATE 16 FEB 2011

- | | | | |
|--|---|---|---|
| <p>STYLE 1:
 PIN 1. EMITTER
 2. COLLECTOR
 3. COLLECTOR
 4. EMITTER
 5. EMITTER
 6. BASE
 7. BASE
 8. EMITTER</p> | <p>STYLE 2:
 PIN 1. COLLECTOR, DIE, #1
 2. COLLECTOR, #1
 3. COLLECTOR, #2
 4. COLLECTOR, #2
 5. BASE, #2
 6. EMITTER, #2
 7. BASE, #1
 8. EMITTER, #1</p> | <p>STYLE 3:
 PIN 1. DRAIN, DIE #1
 2. DRAIN, #1
 3. DRAIN, #2
 4. DRAIN, #2
 5. GATE, #2
 6. SOURCE, #2
 7. GATE, #1
 8. SOURCE, #1</p> | <p>STYLE 4:
 PIN 1. ANODE
 2. ANODE
 3. ANODE
 4. ANODE
 5. ANODE
 6. ANODE
 7. ANODE
 8. COMMON CATHODE</p> |
| <p>STYLE 5:
 PIN 1. DRAIN
 2. DRAIN
 3. DRAIN
 4. DRAIN
 5. GATE
 6. GATE
 7. SOURCE
 8. SOURCE</p> | <p>STYLE 6:
 PIN 1. SOURCE
 2. DRAIN
 3. DRAIN
 4. SOURCE
 5. SOURCE
 6. GATE
 7. GATE
 8. SOURCE</p> | <p>STYLE 7:
 PIN 1. INPUT
 2. EXTERNAL BYPASS
 3. THIRD STAGE SOURCE
 4. GROUND
 5. DRAIN
 6. GATE 3
 7. SECOND STAGE Vd
 8. FIRST STAGE Vd</p> | <p>STYLE 8:
 PIN 1. COLLECTOR, DIE #1
 2. BASE, #1
 3. BASE, #2
 4. COLLECTOR, #2
 5. COLLECTOR, #2
 6. EMITTER, #2
 7. EMITTER, #1
 8. COLLECTOR, #1</p> |
| <p>STYLE 9:
 PIN 1. EMITTER, COMMON
 2. COLLECTOR, DIE #1
 3. COLLECTOR, DIE #2
 4. EMITTER, COMMON
 5. EMITTER, COMMON
 6. BASE, DIE #2
 7. BASE, DIE #1
 8. EMITTER, COMMON</p> | <p>STYLE 10:
 PIN 1. GROUND
 2. BIAS 1
 3. OUTPUT
 4. GROUND
 5. GROUND
 6. BIAS 2
 7. INPUT
 8. GROUND</p> | <p>STYLE 11:
 PIN 1. SOURCE 1
 2. GATE 1
 3. SOURCE 2
 4. GATE 2
 5. DRAIN 2
 6. DRAIN 2
 7. DRAIN 1
 8. DRAIN 1</p> | <p>STYLE 12:
 PIN 1. SOURCE
 2. SOURCE
 3. SOURCE
 4. GATE
 5. DRAIN
 6. DRAIN
 7. DRAIN
 8. DRAIN</p> |
| <p>STYLE 13:
 PIN 1. N.C.
 2. SOURCE
 3. SOURCE
 4. GATE
 5. DRAIN
 6. DRAIN
 7. DRAIN
 8. DRAIN</p> | <p>STYLE 14:
 PIN 1. N-SOURCE
 2. N-GATE
 3. P-SOURCE
 4. P-GATE
 5. P-DRAIN
 6. P-DRAIN
 7. N-DRAIN
 8. N-DRAIN</p> | <p>STYLE 15:
 PIN 1. ANODE 1
 2. ANODE 1
 3. ANODE 1
 4. ANODE 1
 5. CATHODE, COMMON
 6. CATHODE, COMMON
 7. CATHODE, COMMON
 8. CATHODE, COMMON</p> | <p>STYLE 16:
 PIN 1. EMITTER, DIE #1
 2. BASE, DIE #1
 3. EMITTER, DIE #2
 4. BASE, DIE #2
 5. COLLECTOR, DIE #2
 6. COLLECTOR, DIE #2
 7. COLLECTOR, DIE #1
 8. COLLECTOR, DIE #1</p> |
| <p>STYLE 17:
 PIN 1. VCC
 2. V2OUT
 3. V1OUT
 4. TXE
 5. RXE
 6. VEE
 7. GND
 8. ACC</p> | <p>STYLE 18:
 PIN 1. ANODE
 2. ANODE
 3. SOURCE
 4. GATE
 5. DRAIN
 6. DRAIN
 7. CATHODE
 8. CATHODE</p> | <p>STYLE 19:
 PIN 1. SOURCE 1
 2. GATE 1
 3. SOURCE 2
 4. GATE 2
 5. DRAIN 2
 6. MIRROR 2
 7. DRAIN 1
 8. MIRROR 1</p> | <p>STYLE 20:
 PIN 1. SOURCE (N)
 2. GATE (N)
 3. SOURCE (P)
 4. GATE (P)
 5. DRAIN
 6. DRAIN
 7. DRAIN
 8. DRAIN</p> |
| <p>STYLE 21:
 PIN 1. CATHODE 1
 2. CATHODE 2
 3. CATHODE 3
 4. CATHODE 4
 5. CATHODE 5
 6. COMMON ANODE
 7. COMMON ANODE
 8. CATHODE 6</p> | <p>STYLE 22:
 PIN 1. I/O LINE 1
 2. COMMON CATHODE/VCC
 3. COMMON CATHODE/VCC
 4. I/O LINE 3
 5. COMMON ANODE/GND
 6. I/O LINE 4
 7. I/O LINE 5
 8. COMMON ANODE/GND</p> | <p>STYLE 23:
 PIN 1. LINE 1 IN
 2. COMMON ANODE/GND
 3. COMMON ANODE/GND
 4. LINE 2 IN
 5. LINE 2 OUT
 6. COMMON ANODE/GND
 7. COMMON ANODE/GND
 8. LINE 1 OUT</p> | <p>STYLE 24:
 PIN 1. BASE
 2. EMITTER
 3. COLLECTOR/ANODE
 4. COLLECTOR/ANODE
 5. CATHODE
 6. CATHODE
 7. COLLECTOR/ANODE
 8. COLLECTOR/ANODE</p> |
| <p>STYLE 25:
 PIN 1. VIN
 2. N/C
 3. REXT
 4. GND
 5. IOUT
 6. IOUT
 7. IOUT
 8. IOUT</p> | <p>STYLE 26:
 PIN 1. GND
 2. dv/dt
 3. ENABLE
 4. ILIMIT
 5. SOURCE
 6. SOURCE
 7. SOURCE
 8. VCC</p> | <p>STYLE 27:
 PIN 1. ILIMIT
 2. OVLO
 3. UVLO
 4. INPUT+
 5. SOURCE
 6. SOURCE
 7. SOURCE
 8. DRAIN</p> | <p>STYLE 28:
 PIN 1. SW_TO_GND
 2. DASIC OFF
 3. DASIC_SW_DET
 4. GND
 5. V_MON
 6. VBULK
 7. VBULK
 8. VIN</p> |
| <p>STYLE 29:
 PIN 1. BASE, DIE #1
 2. EMITTER, #1
 3. BASE, #2
 4. EMITTER, #2
 5. COLLECTOR, #2
 6. COLLECTOR, #2
 7. COLLECTOR, #1
 8. COLLECTOR, #1</p> | <p>STYLE 30:
 PIN 1. DRAIN 1
 2. DRAIN 1
 3. GATE 2
 4. SOURCE 2
 5. SOURCE 1/DRAIN 2
 6. SOURCE 1/DRAIN 2
 7. SOURCE 1/DRAIN 2
 8. GATE 1</p> | | |

DOCUMENT NUMBER:	98ASB42564B	Electronic versions are uncontrolled except when accessed directly from the Document Repository. Printed versions are uncontrolled except when stamped "CONTROLLED COPY" in red.
DESCRIPTION:	SOIC-8 NB	PAGE 2 OF 2

ON Semiconductor and  are trademarks of Semiconductor Components Industries, LLC dba ON Semiconductor or its subsidiaries in the United States and/or other countries. ON Semiconductor reserves the right to make changes without further notice to any products herein. ON Semiconductor makes no warranty, representation or guarantee regarding the suitability of its products for any particular purpose, nor does ON Semiconductor assume any liability arising out of the application or use of any product or circuit, and specifically disclaims any and all liability, including without limitation special, consequential or incidental damages. ON Semiconductor does not convey any license under its patent rights nor the rights of others.

ON Semiconductor and  are trademarks of Semiconductor Components Industries, LLC dba ON Semiconductor or its subsidiaries in the United States and/or other countries. ON Semiconductor owns the rights to a number of patents, trademarks, copyrights, trade secrets, and other intellectual property. A listing of ON Semiconductor's product/patent coverage may be accessed at www.onsemi.com/site/pdf/Patent-Marking.pdf. ON Semiconductor reserves the right to make changes without further notice to any products herein. ON Semiconductor makes no warranty, representation or guarantee regarding the suitability of its products for any particular purpose, nor does ON Semiconductor assume any liability arising out of the application or use of any product or circuit, and specifically disclaims any and all liability, including without limitation special, consequential or incidental damages. Buyer is responsible for its products and applications using ON Semiconductor products, including compliance with all laws, regulations and safety requirements or standards, regardless of any support or applications information provided by ON Semiconductor. "Typical" parameters which may be provided in ON Semiconductor data sheets and/or specifications can and do vary in different applications and actual performance may vary over time. All operating parameters, including "Typicals" must be validated for each customer application by customer's technical experts. ON Semiconductor does not convey any license under its patent rights nor the rights of others. ON Semiconductor products are not designed, intended, or authorized for use as a critical component in life support systems or any FDA Class 3 medical devices or medical devices with a same or similar classification in a foreign jurisdiction or any devices intended for implantation in the human body. Should Buyer purchase or use ON Semiconductor products for any such unintended or unauthorized application, Buyer shall indemnify and hold ON Semiconductor and its officers, employees, subsidiaries, affiliates, and distributors harmless against all claims, costs, damages, and expenses, and reasonable attorney fees arising out of, directly or indirectly, any claim of personal injury or death associated with such unintended or unauthorized use, even if such claim alleges that ON Semiconductor was negligent regarding the design or manufacture of the part. ON Semiconductor is an Equal Opportunity/Affirmative Action Employer. This literature is subject to all applicable copyright laws and is not for resale in any manner.

PUBLICATION ORDERING INFORMATION

LITERATURE FULFILLMENT:

Email Requests to: orderlit@onsemi.com

ON Semiconductor Website: www.onsemi.com

TECHNICAL SUPPORT

North American Technical Support:
Voice Mail: 1 800-282-9855 Toll Free USA/Canada
Phone: 011 421 33 790 2910

Europe, Middle East and Africa Technical Support:

Phone: 00421 33 790 2910

For additional information, please contact your local Sales Representative

Mouser Electronics

Authorized Distributor

Click to View Pricing, Inventory, Delivery & Lifecycle Information:

[ON Semiconductor:](#)

[NCP5183DR2G](#) [NCV5183DR2G](#)