

50mA and 100mA CMOS LDOs with Shutdown

Features

- Extremely Low Ground Current for Longer Battery Life
- Very Low Dropout Voltage
- Choice of 50mA and 100mA Output (TC1223, TC1224, Respectively)
- High Output Voltage Accuracy
- Standard or Custom Output Voltages
- Power Saving Shutdown Mode
- Over Current and Over Temperature Protection
- Space-Saving 5-Pin SOT-23A Package
- Pin Compatible Upgrades for Bipolar Regulators

Applications

- Battery Operated Systems
- Portable Computers
- Medical Instruments
- Instrumentation
- Cellular/GSM/PHS Phones
- Linear Post-Regulators for SMPS
- Pagers

Device Selection Table

| Part Number | Package | Junction Temp. Range |
|--------------|---------------|----------------------|
| TC1223-xxVCT | 5-Pin SOT-23A | -40°C to +125°C |
| TC1224-xxVCT | 5-Pin SOT-23A | -40°C to +125°C |

NOTE: xx indicates output voltages

Available Output Voltages: 2.5, 2.7, 2.8, 2.85, 3.0, 3.3, 3.6, 4.0, 5.0.

Other output voltages are available. Please contact Microchip Technology Inc. for details.

Package Type



General Description

The TC1223 and TC1224 are high accuracy (typically $\pm 0.5\%$) CMOS upgrades for older (bipolar) low dropout regulators such as the LP2980. Designed specifically for battery-operated systems, the devices' CMOS construction eliminates wasted ground current, significantly extending battery life. Total supply current is typically 50 μ A at full load (20 to 60 times lower than in bipolar regulators).

The devices' key features include ultra low noise operation; very low dropout voltage (typically 85mV, TC1223 and 180mV, TC1224 at full load) and fast response to step changes in load. Supply current is reduced to 0.5 μ A (max) and V_{OUT} falls to zero when the shutdown input is low. The devices incorporate both over temperature and over current protection.

The TC1223 and TC1224 are stable with an output capacitor of only 1 μ F and have a maximum output current of 50mA and 100mA respectively. For higher output current versions, please see the TC1107, TC1108 and TC1173 (I_{OUT} = 300mA) data sheets.

Typical Application



TC1223/TC1224

1.0 ELECTRICAL SPECIFICATIONS

Absolute Maximum Ratings*

| | |
|----------------------------------|-------------------------------------|
| Input Voltage | 6.5V |
| Output Voltage..... | (-0.3V) to (V _{IN} + 0.3V) |
| Power Dissipation..... | Internally Limited |
| Maximum Voltage on Any Pin | V _{IN} +0.3V to -0.3V |
| Operating Temperature Range..... | -40°C < T _J < 125°C |
| Storage Temperature..... | -65°C to +150°C |

Stresses above those listed under "Absolute Maximum Ratings" may cause permanent damage to the device. These are stress ratings only and functional operation of the device at these or any other conditions above those indicated in the operation sections of the specifications is not implied. Exposure to Absolute Maximum Rating conditions for extended periods may affect device reliability.

TC1223/TC1224 ELECTRICAL SPECIFICATIONS

| Electrical Characteristics: V _{IN} = V _{OUT} + 1V, I _L = 100μA, C _L = 3.3μF, $\overline{\text{SHDN}} > V_{IH}$, T _A = 25°C, unless otherwise noted. Boldface type specifications apply for junction temperatures of -40°C to +125°C. | | | | | | |
|---|---|-----------------------------|----------------------|-----------------------------|------------------|--|
| Symbol | Parameter | Min | Typ | Max | Units | Test Conditions |
| V _{IN} | Input Operating Voltage | 2.7 | — | 6.0 | V | Note 8 |
| I _{OUTMAX} | Maximum Output Current | 50 100 | — | — | mA | TC1223 TC1224 |
| V _{OUT} | Output Voltage | V_R - 2.5% | V _R ±0.5% | V_R + 2.5% | V | Note 1 |
| TCV _{OUT} | V _{OUT} Temperature Coefficient | — | 20 40 | — | ppm/°C | Note 2 |
| ΔV _{OUT} /ΔV _{IN} | Line Regulation | — | 0.05 | 0.35 | % | (V _R + 1V) ≤ V _{IN} ≤ 6V |
| ΔV _{OUT} /V _{OUT} | Load Regulation | — | 0.5 | 2 | % | I _L = 0.1mA to I _{OUTMAX} (Note 3) |
| V _{IN} -V _{OUT} | Dropout Voltage | — | 2 65 85 180 | — | mV | I _L = 100μA I _L = 20mA I _L = 50mA I _L = 100mA (Note 4) |
| I _{IN} | Supply Current | — | 50 | 80 | μA | SHDN = V _{IH} , I _L = 0 (Note 7) |
| I _{INSD} | Shutdown Supply Current | — | 0.05 | 0.5 | μA | SHDN = 0V |
| PSRR | Power Supply Rejection Ratio | — | 64 | — | dB | F _{RE} ≤ 1kHz |
| I _{OUTsc} | Output Short Circuit Current | — | 300 | 450 | mA | V _{OUT} = 0V |
| ΔV _{OUT} /ΔP _D | Thermal Regulation | — | 0.04 | — | V/W | Notes 5, 6 |
| T _{SD} | Thermal Shutdown Die Temperature | — | 160 | — | °C | |
| ΔT _{SD} | Thermal Shutdown Hysteresis | — | 10 | — | °C | |
| eN | Output Noise | — | 260 | — | nV/√Hz | I _L = I _{OUTMAX} |
| SHDN Input | | | | | | |
| V _{IH} | $\overline{\text{SHDN}}$ Input High Threshold | 45 | — | — | %V _{IN} | V _{IN} = 2.5V to 6.5V |
| V _{IL} | $\overline{\text{SHDN}}$ Input Low Threshold | — | — | 15 | %V _{IN} | V _{IN} = 2.5V to 6.5V |

- Note** 1: V_R is the regulator output voltage setting. For example: V_R = 2.5V, 2.7V, 2.85V, 3.0V, 3.3V, 3.6V, 4.0V, 5.0V.
 2: TC V_{OUT} = $\frac{(V_{OUTMAX} - V_{OUTMIN}) \times 10^6}{V_{OUT} \times \Delta T}$
 3: Regulation is measured at a constant junction temperature using low duty cycle pulse testing. Load regulation is tested over a load range from 0.1mA to the maximum specified output current. Changes in output voltage due to heating effects are covered by the thermal regulation specification.
 4: Dropout voltage is defined as the input to output differential at which the output voltage drops 2% below its nominal value at a 1V differential.
 5: Thermal Regulation is defined as the change in output voltage at a time T after a change in power dissipation is applied, excluding load or line regulation effects. Specifications are for a current pulse equal to I_{LMAX} at V_{IN} = 6V for T = 10 msec.
 6: The maximum allowable power dissipation is a function of ambient temperature, the maximum allowable junction temperature and the thermal resistance from junction-to-air (i.e., T_A, T_J, θ_{JA}). Exceeding the maximum allowable power dissipation causes the device to initiate thermal shutdown. Please see Section 4.0 Thermal Considerations for more details.
 7: Apply for Junction Temperatures of -40°C to +85°C.
 8: The minimum V_{IN} has to justify the conditions: V_{IN} ≥ V_R + V_{DROPOUT} and V_{IN} ≥ 2.7V for I_L = 0.1mA to I_{OUTMAX}.

2.0 PIN DESCRIPTIONS

The descriptions of the pins are listed in Table 2-1.

TABLE 2-1: PIN FUNCTION TABLE

| Pin No. (5-Pin SOT-23A) | Symbol | Description |
|----------------------------|--------------------------|---|
| 1 | V_{IN} | Unregulated supply input. |
| 2 | GND | Ground terminal. |
| 3 | $\overline{\text{SHDN}}$ | Shutdown control input. The regulator is fully enabled when a logic high is applied to this input. The regulator enters shutdown when a logic low is applied to this input. During shutdown, output voltage falls to zero and supply current is reduced to 0.5 μ A (max). |
| 4 | NC | No connect. |
| 5 | V_{OUT} | Regulated voltage output. |

TC1223/TC1224

3.0 DETAILED DESCRIPTION

The TC1223 and TC1224 are precision fixed output voltage regulators. Unlike bipolar regulators, the TC1223 and TC1224's supply current does not increase with load current. In addition, V_{OUT} remains stable and within regulation over the entire 0mA to I_{OUTMAX} operating load current range, (an important consideration in RTC and CMOS RAM battery back-up applications).

Figure 3-1 shows a typical application circuit. The regulator is enabled any time the shutdown input (SHDN) is at or above V_{IH} , and shutdown (disabled) when SHDN is at or below V_{IL} . SHDN may be controlled by a CMOS logic gate, or I/O port of a microcontroller. If the SHDN input is not required, it should be connected directly to the input supply. While in shutdown, supply current decreases to 0.05 μ A (typical) and V_{OUT} falls to zero volts.

3.1 Output Capacitor

A 1 μ F (min) capacitor from V_{OUT} to ground is recommended. The output capacitor should have an effective series resistance greater than 0.1 Ω and less than 5.0 Ω , and a resonant frequency above 1MHz. A 1 μ F capacitor should be connected from V_{IN} to GND if there is more than 10 inches of wire between the regulator and the AC filter capacitor, or if a battery is used as the power source. Aluminum electrolytic or tantalum capacitor types can be used. (Since many aluminum electrolytic capacitors freeze at approximately -30 $^{\circ}$ C, solid tantalums are recommended for applications operating below -25 $^{\circ}$ C.) When operating from sources other than batteries, supply-noise rejection and transient response can be improved by increasing the value of the input and output capacitors and employing passive filtering techniques.

FIGURE 3-1: TYPICAL APPLICATION CIRCUIT

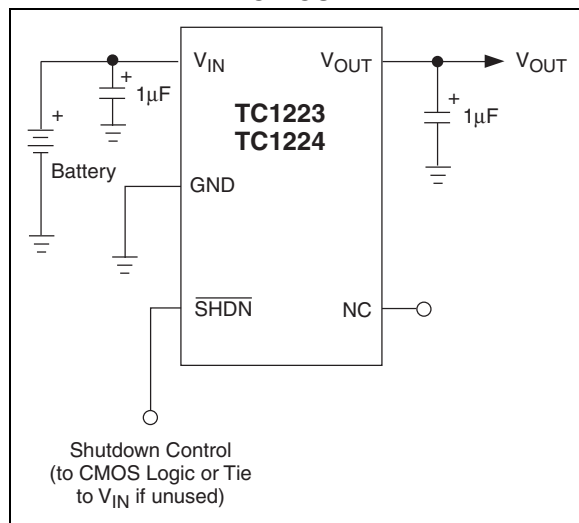

4.0 THERMAL CONSIDERATIONS

4.1 Thermal Shutdown

Integrated thermal protection circuitry shuts the regulator off when die temperature exceeds 160°C. The regulator remains off until the die temperature drops to approximately 150°C.

4.2 Power Dissipation

The amount of power the regulator dissipates is primarily a function of input and output voltage, and output current. The following equation is used to calculate worst case actual power dissipation:

EQUATION 4-1:

$$P_D \approx (V_{INMAX} - V_{OUTMIN})I_{LOADMAX}$$

Where:

P_D = Worst case actual power dissipation
 V_{INMAX} = Maximum voltage on V_{IN}
 V_{OUTMIN} = Minimum regulator output voltage
 $I_{LOADMAX}$ = Maximum output (load) current

The maximum allowable power dissipation (Equation 4-2) is a function of the maximum ambient temperature (T_{AMAX}), the maximum allowable die temperature (T_{JMAX}) and the thermal resistance from junction-to-air (θ_{JA}). The 5-Pin SOT-23A package has a θ_{JA} of approximately 220°C/Watt.

EQUATION 4-2:

$$P_{DMAX} = \frac{(T_{JMAX} - T_{AMAX})}{\theta_{JA}}$$

Where all terms are previously defined.

Equation 4-1 can be used in conjunction with Equation 4-2 to ensure regulator thermal operation is within limits. For example:

Given:

$$\begin{aligned} V_{INMAX} &= 3.0V \pm 10\% \\ V_{OUTMIN} &= 2.7V - 2.5\% \\ I_{LOADMAX} &= 40mA \\ T_{JMAX} &= 125^\circ C \\ T_{AMAX} &= 55^\circ C \end{aligned}$$

Find: 1. Actual power dissipation
 2. Maximum allowable dissipation

Actual power dissipation:

$$\begin{aligned} P_D &\approx (V_{INMAX} - V_{OUTMIN})I_{LOADMAX} \\ &= [(3.0 \times 1.1) - (2.7 \times .975)]40 \times 10^{-3} \\ &= 26.7mW \end{aligned}$$

Maximum allowable power dissipation:

$$\begin{aligned} P_{DMAX} &= \frac{(T_{JMAX} - T_{AMAX})}{\theta_{JA}} \\ &= \frac{(125 - 55)}{220} \\ &= 318mW \end{aligned}$$

In this example, the TC1223 dissipates a maximum of 26.7mW; below the allowable limit of 318mW. In a similar manner, Equation 4-1 and Equation 4-2 can be used to calculate maximum current and/or input voltage limits.

4.3 Layout Considerations

The primary path of heat conduction out of the package is via the package leads. Therefore, layouts having a ground plane, wide traces at the pads, and wide power supply bus lines combine to lower θ_{JA} and therefore increase the maximum allowable power dissipation limit.

TC1223/TC1224

5.0 TYPICAL CHARACTERISTICS

(Unless Otherwise Specified, All Parts Are Measured At Temperature = 25°C)

Note: The graphs and tables provided following this note are a statistical summary based on a limited number of samples and are provided for informational purposes only. The performance characteristics listed herein are not tested or guaranteed. In some graphs or tables, the data presented may be outside the specified operating range (e.g., outside specified power supply range) and therefore outside the warranted range.

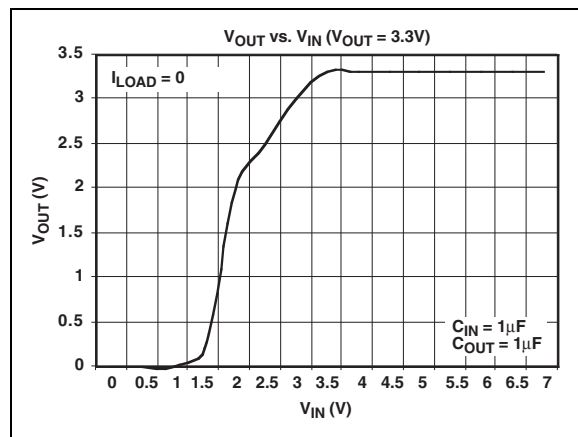
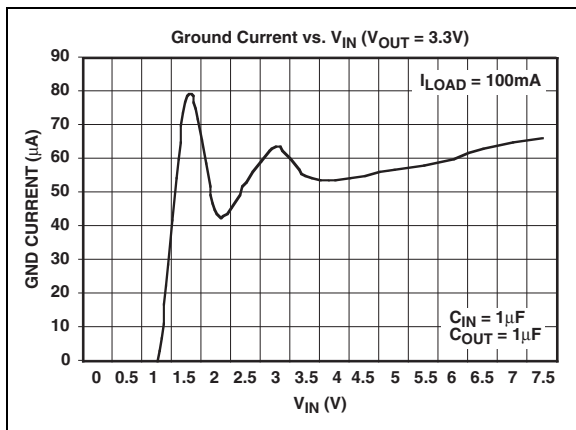
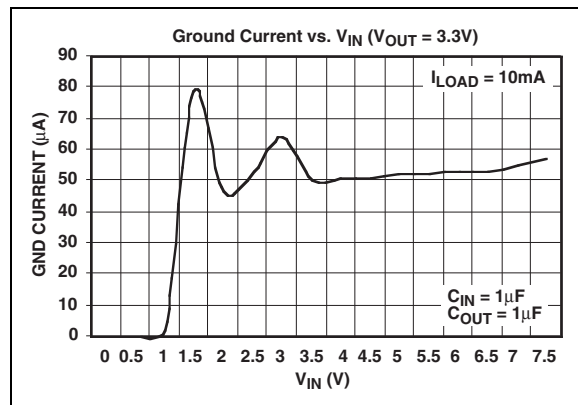
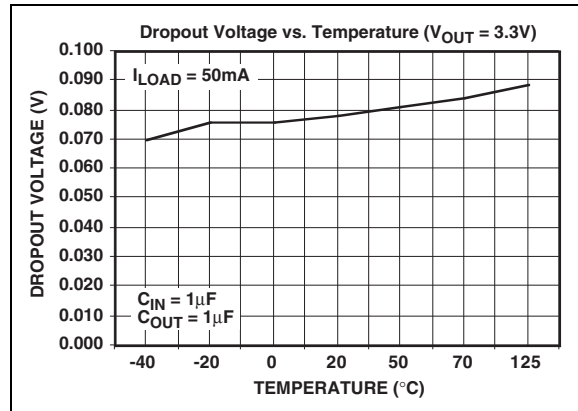
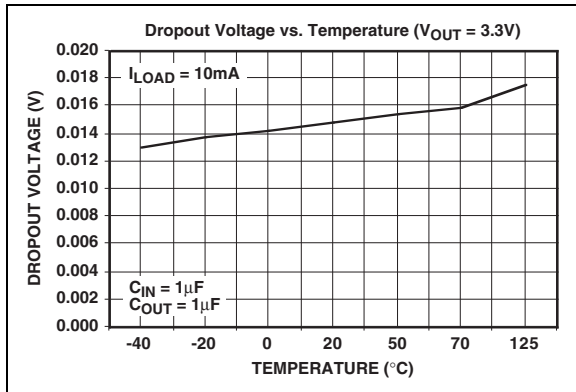

5.0 TYPICAL CHARACTERISTICS (CONTINUED)

(Unless Otherwise Specified, All Parts Are Measured At Temperature = 25°C)

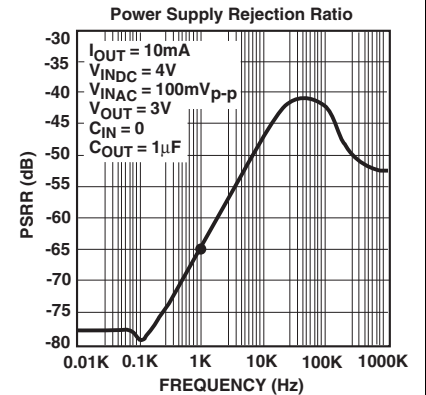
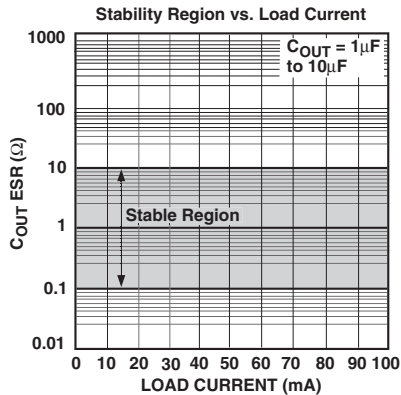
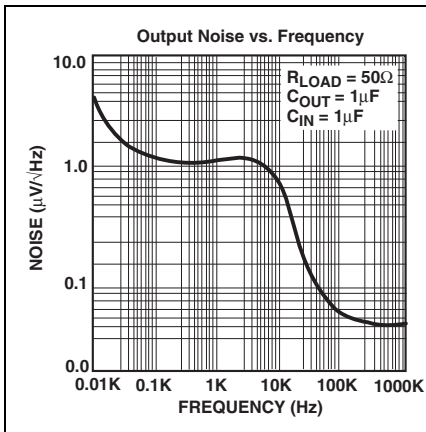
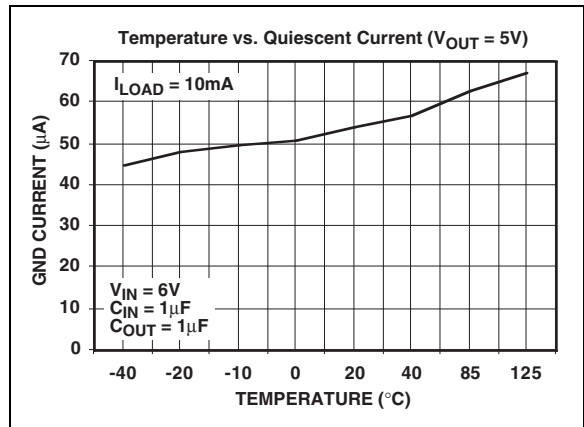
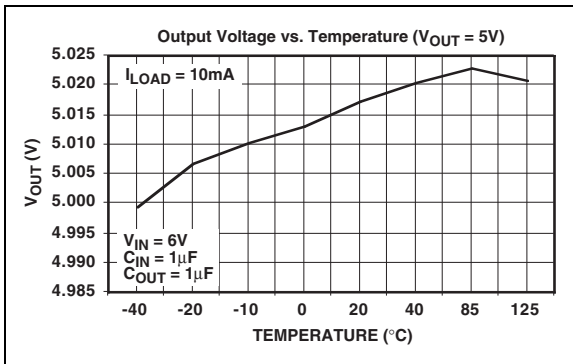
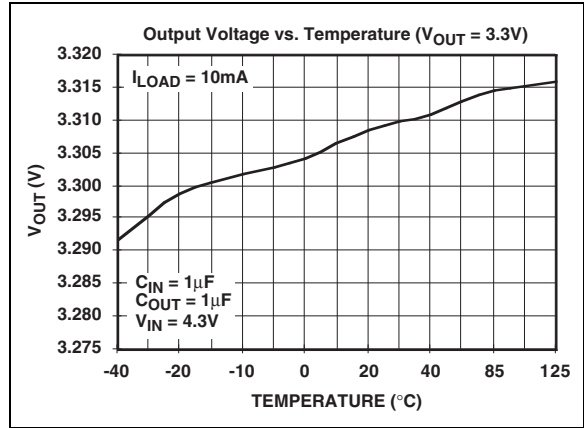
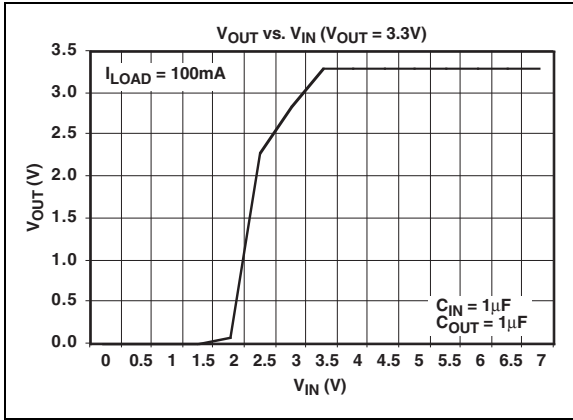

TC1223/TC1224

5.0 TYPICAL CHARACTERISTICS (CONTINUED)

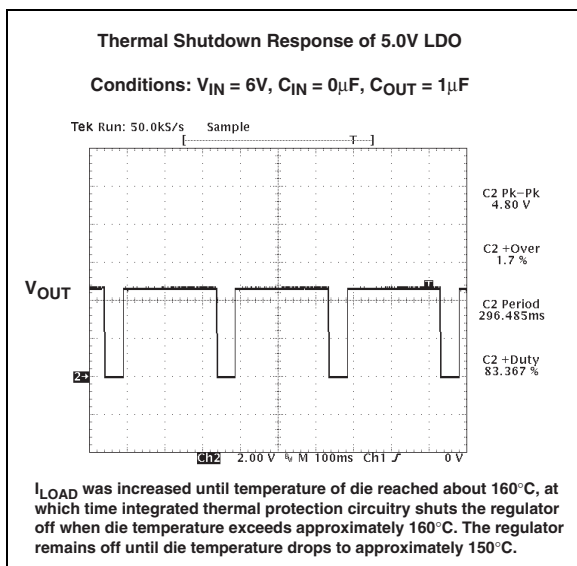
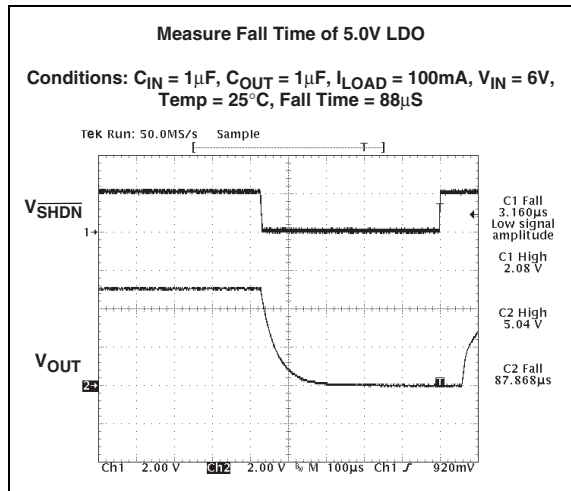
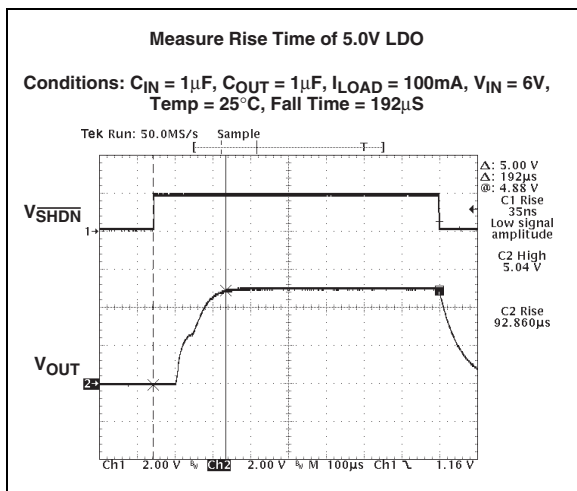
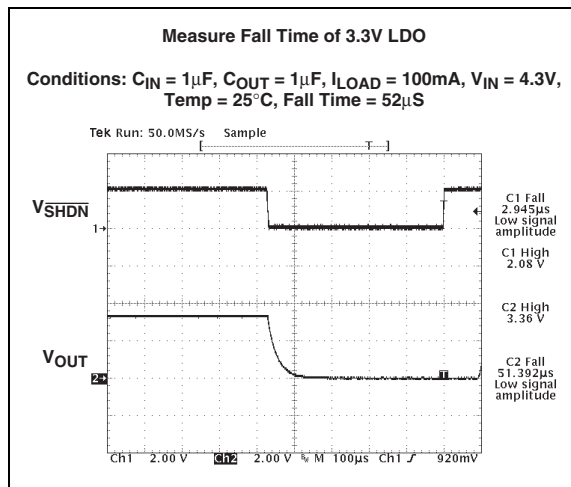
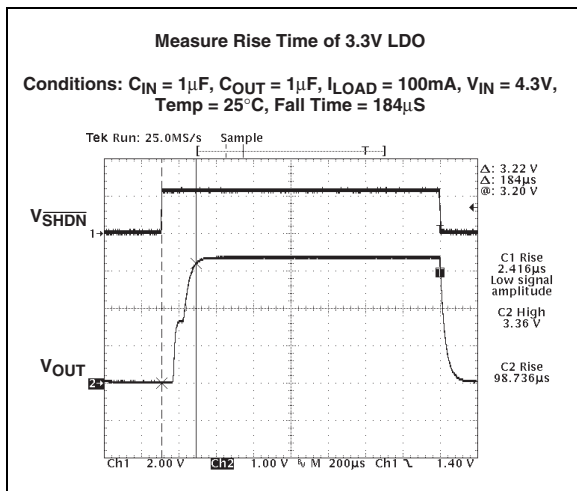

6.0 PACKAGING INFORMATION

6.1 Package Marking Information

“1” & “2” = part number code + temperature range and voltage

| (V) | TC1223 Code | TC1224 Code |
|------|-------------|-------------|
| 2.5 | L1 | M1 |
| 2.7 | L2 | M2 |
| 2.8 | LZ | MZ |
| 2.85 | L8 | M8 |
| 3.0 | L3 | M3 |
| 3.3 | L5 | M5 |
| 3.6 | L9 | M9 |
| 4.0 | L0 | M0 |
| 5.0 | L7 | M7 |

“3” represents year and quarter code

“4” represents lot ID number

6.2 Taping Form

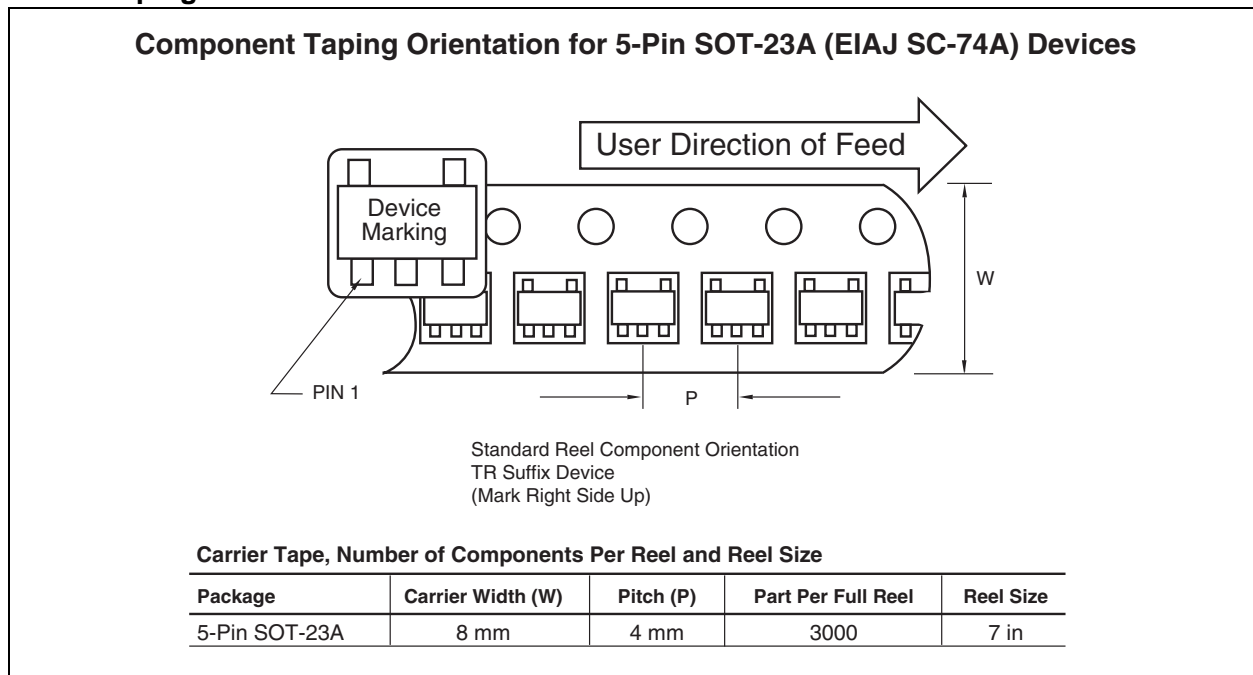

TC1223/TC1224

6.3 Package Dimensions

Note: For the most current package drawings, please see the Microchip Packaging Specification located at <http://www.microchip.com/packaging>

SOT-23A-5

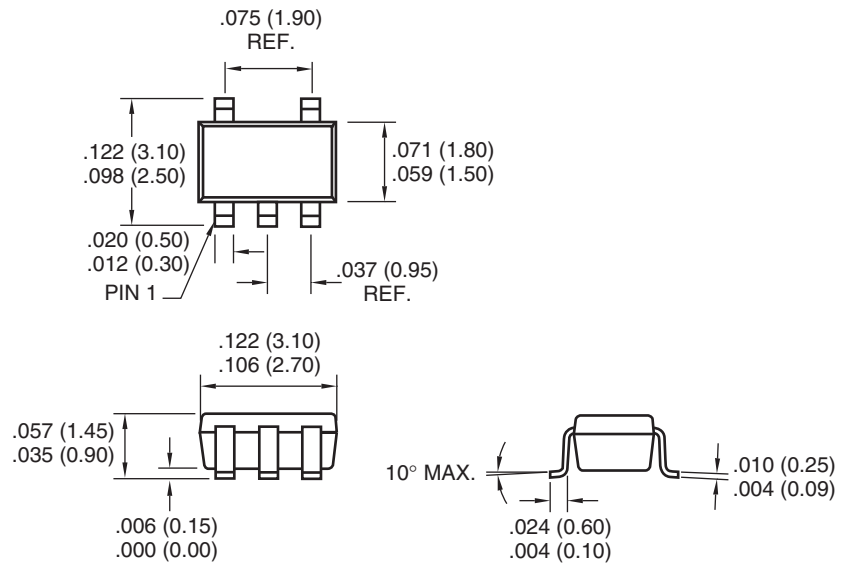

Dimensions: inches (mm)

7.0 REVISION HISTORY

Revision C (November 2012)

Added a note to each package outline drawing.

TC1223/TC1224

NOTES:

SALES AND SUPPORT

Data Sheets

Products supported by a preliminary Data Sheet may have an errata sheet describing minor operational differences and recommended workarounds. To determine if an errata sheet exists for a particular device, please contact one of the following:

1. Your local Microchip sales office
2. The Microchip Worldwide Site (www.microchip.com)

Please specify which device, revision of silicon and Data Sheet (include Literature #) you are using.

New Customer Notification System

Register on our web site (www.microchip.com/cn) to receive the most current information on our products.

TC1223/TC1224

NOTES:

Note the following details of the code protection feature on Microchip devices:

- Microchip products meet the specification contained in their particular Microchip Data Sheet.
- Microchip believes that its family of products is one of the most secure families of its kind on the market today, when used in the intended manner and under normal conditions.
- There are dishonest and possibly illegal methods used to breach the code protection feature. All of these methods, to our knowledge, require using the Microchip products in a manner outside the operating specifications contained in Microchip's Data Sheets. Most likely, the person doing so is engaged in theft of intellectual property.
- Microchip is willing to work with the customer who is concerned about the integrity of their code.
- Neither Microchip nor any other semiconductor manufacturer can guarantee the security of their code. Code protection does not mean that we are guaranteeing the product as “unbreakable.”

Code protection is constantly evolving. We at Microchip are committed to continuously improving the code protection features of our products. Attempts to break Microchip's code protection feature may be a violation of the Digital Millennium Copyright Act. If such acts allow unauthorized access to your software or other copyrighted work, you may have a right to sue for relief under that Act.

Information contained in this publication regarding device applications and the like is provided only for your convenience and may be superseded by updates. It is your responsibility to ensure that your application meets with your specifications. MICROCHIP MAKES NO REPRESENTATIONS OR WARRANTIES OF ANY KIND WHETHER EXPRESS OR IMPLIED, WRITTEN OR ORAL, STATUTORY OR OTHERWISE, RELATED TO THE INFORMATION, INCLUDING BUT NOT LIMITED TO ITS CONDITION, QUALITY, PERFORMANCE, MERCHANTABILITY OR FITNESS FOR PURPOSE. Microchip disclaims all liability arising from this information and its use. Use of Microchip devices in life support and/or safety applications is entirely at the buyer's risk, and the buyer agrees to defend, indemnify and hold harmless Microchip from any and all damages, claims, suits, or expenses resulting from such use. No licenses are conveyed, implicitly or otherwise, under any Microchip intellectual property rights.

Trademarks

The Microchip name and logo, the Microchip logo, dsPIC, FlashFlex, KEELOQ, KEELOQ logo, MPLAB, PIC, PICmicro, PICSTART, PIC³² logo, rPIC, SST, SST Logo, SuperFlash and UNI/O are registered trademarks of Microchip Technology Incorporated in the U.S.A. and other countries.

FilterLab, Hampshire, HI-TECH C, Linear Active Thermistor, MTP, SEEVAL and The Embedded Control Solutions Company are registered trademarks of Microchip Technology Incorporated in the U.S.A.

Silicon Storage Technology is a registered trademark of Microchip Technology Inc. in other countries.

Analog-for-the-Digital Age, Application Maestro, BodyCom, chipKIT, chipKIT logo, CodeGuard, dsPICDEM, dsPICDEM.net, dsPICworks, dsSPEAK, ECAN, ECONOMONITOR, FanSense, HI-TIDE, In-Circuit Serial Programming, ICSP, Mindi, MiWi, MPASM, MPF, MPLAB Certified logo, MPLIB, MPLINK, mTouch, Omniclient Code Generation, PICC, PICC-18, PICDEM, PICDEM.net, PICkit, PICtail, REAL ICE, rLAB, Select Mode, SQI, Serial Quad I/O, Total Endurance, TSHARC, UniWinDriver, WiperLock, ZENA and Z-Scale are trademarks of Microchip Technology Incorporated in the U.S.A. and other countries.

SQTP is a service mark of Microchip Technology Incorporated in the U.S.A.

GestIC and ULPP are registered trademarks of Microchip Technology Germany II GmbH & Co. & KG, a subsidiary of Microchip Technology Inc., in other countries.

All other trademarks mentioned herein are property of their respective companies.

© 2002-2012, Microchip Technology Incorporated, Printed in the U.S.A., All Rights Reserved.

 Printed on recycled paper.

ISBN: 9781620767382

QUALITY MANAGEMENT SYSTEM
CERTIFIED BY DNV
== ISO/TS 16949 ==

Microchip received ISO/TS-16949:2009 certification for its worldwide headquarters, design and wafer fabrication facilities in Chandler and Tempe, Arizona; Gresham, Oregon and design centers in California and India. The Company's quality system processes and procedures are for its PIC[®] MCUs and dsPIC[®] DSCs, KEELOQ[®] code hopping devices, Serial EEPROMs, microperipherals, nonvolatile memory and analog products. In addition, Microchip's quality system for the design and manufacture of development systems is ISO 9001:2000 certified.



MICROCHIP

Worldwide Sales and Service

AMERICAS

Corporate Office
2355 West Chandler Blvd.
Chandler, AZ 85224-6199
Tel: 480-792-7200
Fax: 480-792-7277
Technical Support:
<http://www.microchip.com/support>
Web Address:
www.microchip.com

Atlanta
Duluth, GA
Tel: 678-957-9614
Fax: 678-957-1455

Boston
Westborough, MA
Tel: 774-760-0087
Fax: 774-760-0088

Chicago
Itasca, IL
Tel: 630-285-0071
Fax: 630-285-0075

Cleveland
Independence, OH
Tel: 216-447-0464
Fax: 216-447-0643

Dallas
Addison, TX
Tel: 972-818-7423
Fax: 972-818-2924

Detroit
Farmington Hills, MI
Tel: 248-538-2250
Fax: 248-538-2260

Indianapolis
Noblesville, IN
Tel: 317-773-8323
Fax: 317-773-5453

Los Angeles
Mission Viejo, CA
Tel: 949-462-9523
Fax: 949-462-9608

Santa Clara
Santa Clara, CA
Tel: 408-961-6444
Fax: 408-961-6445

Toronto
Mississauga, Ontario,
Canada
Tel: 905-673-0699
Fax: 905-673-6509

ASIA/PACIFIC

Asia Pacific Office
Suites 3707-14, 37th Floor
Tower 6, The Gateway
Harbour City, Kowloon
Hong Kong
Tel: 852-2401-1200
Fax: 852-2401-3431

Australia - Sydney
Tel: 61-2-9868-6733
Fax: 61-2-9868-6755

China - Beijing
Tel: 86-10-8569-7000
Fax: 86-10-8528-2104

China - Chengdu
Tel: 86-28-8665-5511
Fax: 86-28-8665-7889

China - Chongqing
Tel: 86-23-8980-9588
Fax: 86-23-8980-9500

China - Hangzhou
Tel: 86-571-2819-3187
Fax: 86-571-2819-3189

China - Hong Kong SAR
Tel: 852-2401-1200
Fax: 852-2401-3431

China - Nanjing
Tel: 86-25-8473-2460
Fax: 86-25-8473-2470

China - Qingdao
Tel: 86-532-8502-7355
Fax: 86-532-8502-7205

China - Shanghai
Tel: 86-21-5407-5533
Fax: 86-21-5407-5066

China - Shenyang
Tel: 86-24-2334-2829
Fax: 86-24-2334-2393

China - Shenzhen
Tel: 86-755-8203-2660
Fax: 86-755-8203-1760

China - Wuhan
Tel: 86-27-5980-5300
Fax: 86-27-5980-5118

China - Xian
Tel: 86-29-8833-7252
Fax: 86-29-8833-7256

China - Xiamen
Tel: 86-592-2388138
Fax: 86-592-2388130

China - Zhuhai
Tel: 86-756-3210040
Fax: 86-756-3210049

ASIA/PACIFIC

India - Bangalore
Tel: 91-80-3090-4444
Fax: 91-80-3090-4123

India - New Delhi
Tel: 91-11-4160-8631
Fax: 91-11-4160-8632

India - Pune
Tel: 91-20-2566-1512
Fax: 91-20-2566-1513

Japan - Osaka
Tel: 81-66-152-7160
Fax: 81-66-152-9310

Japan - Yokohama
Tel: 81-45-471-6166
Fax: 81-45-471-6122

Korea - Daegu
Tel: 82-53-744-4301
Fax: 82-53-744-4302

Korea - Seoul
Tel: 82-2-554-7200
Fax: 82-2-558-5932 or
82-2-558-5934

Malaysia - Kuala Lumpur
Tel: 60-3-6201-9857
Fax: 60-3-6201-9859

Malaysia - Penang
Tel: 60-4-227-8870
Fax: 60-4-227-4068

Philippines - Manila
Tel: 63-2-634-9065
Fax: 63-2-634-9069

Singapore
Tel: 65-6334-8870
Fax: 65-6334-8850

Taiwan - Hsin Chu
Tel: 886-3-5778-366
Fax: 886-3-5770-955

Taiwan - Kaohsiung
Tel: 886-7-213-7828
Fax: 886-7-330-9305

Taiwan - Taipei
Tel: 886-2-2508-8600
Fax: 886-2-2508-0102

Thailand - Bangkok
Tel: 66-2-694-1351
Fax: 66-2-694-1350

EUROPE

Austria - Wels
Tel: 43-7242-2244-39
Fax: 43-7242-2244-393

Denmark - Copenhagen
Tel: 45-4450-2828
Fax: 45-4485-2829

France - Paris
Tel: 33-1-69-53-63-20
Fax: 33-1-69-30-90-79

Germany - Munich
Tel: 49-89-627-144-0
Fax: 49-89-627-144-44

Italy - Milan
Tel: 39-0331-742611
Fax: 39-0331-466781

Netherlands - Drunen
Tel: 31-416-690399
Fax: 31-416-690340

Spain - Madrid
Tel: 34-91-708-08-90
Fax: 34-91-708-08-91

UK - Wokingham
Tel: 44-118-921-5869
Fax: 44-118-921-5820

10/26/12

Mouser Electronics

Authorized Distributor

Click to View Pricing, Inventory, Delivery & Lifecycle Information:

Microchip:

[TC1224-2.6VCTTR](#) [TC1224-3.6VCTTR](#) [TC1224-2.5VCTTR](#) [TC1224-2.85VCTTR](#) [TC1223-3.0VCTTR](#) [TC1223-5.0VCTTR](#) [TC1223-4.0VCTTR](#) [TC1224-2.7VCTTR](#) [TC1223-3.6VCTTR](#) [TC1223-3.3VCTTR](#) [TC1223-2.6VCTTR](#) [TC1224-3.3VCTTR](#) [TC1223-2.5VCTTR](#) [TC1224-3.0VCTTR](#) [TC1224-4.0VCTTR](#) [TC1224-5.0VCTTR](#) [TC1223-2.85VCTTR](#) [TC1224-2.8VCTTR](#) [TC1223-2.7VCTTR](#) [TC1223-2.8VCTTR](#)