

# 1PS/1QS/1RS

Rectangular caps • concave surface •  
different illumination options



## DISTINCTIVE FEATURES

Rectangular caps 6.5 x 12.5 mm

h=15.7 mm

Concave top surface

Full or lens illumination option

5E/5G + 1PS; 5G + 1QS/1RS



SWITCH SPECIFICATIONS : see Multimec™ 5 series.

### 5E+1PS - SMD

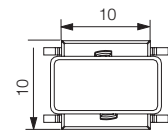
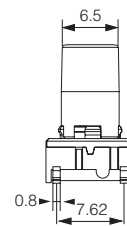
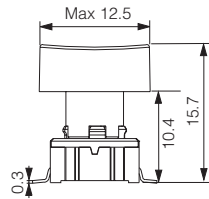

### 5G+1QS - TH W/LED

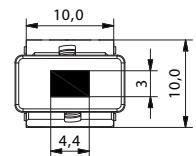
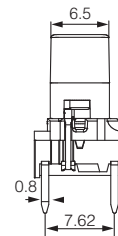
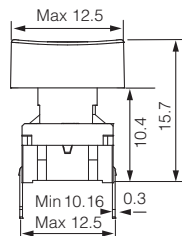

### 5G+1RS - TH W/LED

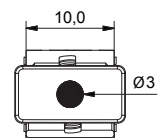
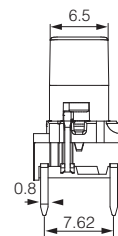
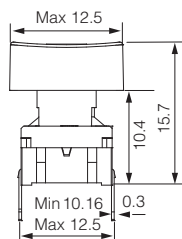

# 1PS/1QS/1RS

Rectangular caps • concave surface • different illumination options



## BUILD YOUR PART NUMBER

### ILLUMINATED

SERIES	MOUNTING	ACTUATION FORCE	LED	CAP	COLOR	LENS
<b>5G</b>						
	<b>TH9</b> through-hole	<b>20</b> 2.0N	<b>02</b> blue	<b>1PS</b>	<b>1PS</b>	<b>1</b> transparent
	<b>SH9</b> surface mount	<b>35</b> 3.5N	<b>22</b> green	<b>1QS</b>	<b>11</b> transparent	<b>6</b> frosted white
		<b>65</b> 6.5N	<b>29</b> high intensity green	<b>1RS</b>	<b>16</b> frosted white	
			<b>42</b> yellow		<b>1QS</b>	
			<b>61</b> white		<b>00</b> blue	
			<b>82</b> red		<b>03</b> grey	
			<b>2242</b> green/yellow		<b>09</b> black	
			<b>8222</b> red/green		<b>1RS</b>	
			<b>8242</b> red/yellow		<b>03</b> grey	

### NON-ILLUMINATED

SERIES	MOUNTING	ACTUATION FORCE	CAP	COLOR
<b>5E</b>			<b>1PS</b>	
	<b>TH9</b> through-hole	<b>20</b> 2.0N		<b>00</b> blue
	<b>SH9</b> surface mount	<b>35</b> 3.5N		<b>02</b> green
		<b>65</b> 6.5N		<b>03</b> grey
				<b>04</b> yellow
				<b>06</b> white
				<b>08</b> red
				<b>09</b> black

**NOTICE** : Please note that not all combinations of above numbers are available.  
Other versions : Please refer to [www.apem.com](http://www.apem.com) for information on the 3F & 4F series versions - 1P/1Q/1R



## MOUNTING

- Panel cut-out : min. 7.0 x 13.0 mm, R max 1.0
- Switch spacing AxB : min. 12.8 x 10.3 mm



## MATERIALS

- Cap :
  - solid color : ABS UL94HB
  - illuminated : polycarbonate UL94HB
- Lens : polycarbonate UL94HB

# Legends

Available for Multimec caps



## STANDARD LEGENDS

STANDARD LEGENDS									
LEGEND	1DS09_	1FS096R_	1ZB09D_ 1ZB16DLMH_	1ZCS_	1Z_ 1ZW_	10A_	10C_	10Q_ 10QM16_	10R_ & 10RF_ 10RM16_
0	000	000							
1	001	001							
2	002	002							
3	003	003							
4	004	004							
5	005	005							
6	006	006							
7	007	007							
8	008	008							
9	009	009							
#	107	107							
*	019	019							
←	033								
→	133								
↑	034								
↓	134								
↙	135	135							
+						054		054	054
-						059		059	059
▲			136		136	136			
⏻	123	123		123*	123		123	123	123
ON/OFF								017	017
STOP								018	018
START								031	031
RESET				038				038	038
CANCEL								048	048
ENTER								105	105
ESC				051					
ON						116			
OFF						117			
OK				118*	118		118	118	118
SET				119					
MENU				120					
FUNC				121					
HOME				122					

### STANDARD OPTIONS

- 1DS: pad printed
- 1FS: reverse printed
- 1ZB: pad printed / laser marked
- 1ZCS: pad printed / \*reverse printed / \*laser marked
- 1Z & 1ZW: pad printed / laser marked
- 10A: pad printed / laser marked
- 10C: pad printed / laser marked
- 10R(F) & 10Q: pad printed / reverse printed
- 10RM & 10QM: metal symbol



## HOW TO ORDER

### POSITIONING OF LEGENDS ON ROCKER-ACTION CAPS

When ordering legends for caps with hinge-type cap retention system, it is important to note the position of the cap. An extra letter (U, D, R or L) needs to be added to the part number to refer to the position of the hinges in relation to the legend. See samples:

Rocker-action caps without a lens: 1A, 1B, 1M, 1ZA and 1ZB

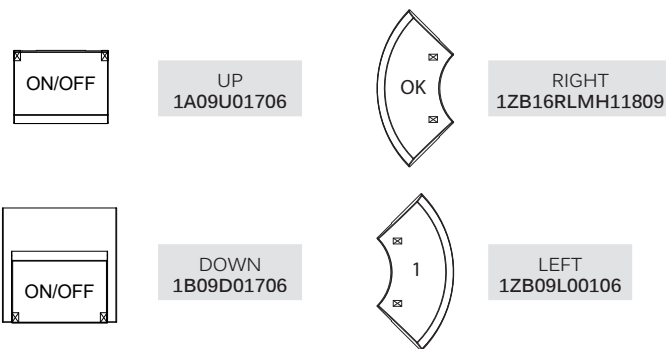

### LEGEND ILLUMINATION

- **Option 1 - laser marked:** In case of laser marked legends an "LM" is added after the cap colour, before the legend code. We recommend using hard paint (additional "H" ) for increased lifetime of the paint. E.g. 1ZB16DLMH13609
- **Option 2 - reverse printed:** In case of reverse printed caps an "R" is added after the cap colour, before the legend code. Especially relevant when standard legends have both negative and positive print options. E.g. 1FS096R00009
- **Option 3 - metal symbol:** Only available for 10RM and 10QM (therefore the "M"). E.g. 10RM16059

### ORIENTATION OF THE SWITCH



### STANDARD AND CUSTOM LEGENDS

- Standard are only certain legends on certain caps. See the table on the previous page.
- All standard pad-printed legends are white on black caps.
- All standard reverse-printed and laser marked legends are black on frosted white cap.

### STANDARD LEGENDS

CAP	CAP COLOR	DIRECTION*	TYPE*	LEGEND	LEGEND COLOR*	
1DS	00 Blue	D Down	UV UV printed	001 1	00 Blue	
1FS	02 Green	U Up	LM Laser marked on soft paint	002 2	02 Green	
...	03 Grey	R Right	LMH Laser marked on hard paint	003 3	03 Grey	
	04 Yellow	L Left	R Reverse printed	... etc	04 Yellow	
	06 White	*Only for hinge-type caps			06 White	
	08 Red		*In case of illumination		08 Red	
	09 Black				09 Black	
	16 Frosted white				... Etc	
	... Etc				*In case of reverse printed and laser marked legends the colour of the paint	













































**Notice:** The size of the legends listed may not correspond to the actual size.

If you decide to use one of the standard legends without any adjustments (without a new cliché or programming) on another cap than designated in the table, then there is no cliché or programming cost, for this to apply the cap has to be black and the print white.

For further information on legends please contact your local distributor or MEC.

# Solid colors

Available for Multimec™ caps

		Colour / RAL Code																			
		Blue / 5012	green / 6018	Grey / 7004	Yellow / 1023	White / 9010	Red / 3000	Black / 9004	Ultra blue / 5002	Mint green / 6029	Tele grey / 7046	Melon / 1028	Signal white / 9003	Noble red / 3002	Dusty blue / 5014	Aqua blue / 5021	Metal dark blue / No ral code	Metal light grey / No ral code	Metal dark grey / No ral code	Metal bordeaux / No ral code	
																					
CAP	CODE	00	02	03	04	06	08	09	30	32	33	34	36	38	40	42	50	53	57	58	
1A		•	•	•	•	•	•	•													
1B		•	•	•	•	•	•	•													
1DS		•	•	•	•	•	•	•	•	•	•	•		•	•	•	•	•	•	•	•
1ES/1FS				•			•	•													
1GAS/1GCS		•	•	•	•	•	•	•													
1H				•				•													
1JS		•	•	•	•	•	•	•													
1KS		•	•	•	•	•	•	•													
1LS								•													
1M			•	•			•	•													
1NS				•				•													
1PS		•	•	•	•	•	•	•													
1QS		•		•				•													
1RS				•																	
1SS		•	•	•	•	•	•	•													
1TS/1US/1VS		•		•			•	•													
1WAS/1WDS/1WPS				•				•													
1XS				•		•		•													
1ZA				•		•		•	•						•	•	•	•	•	•	•
1ZB				•		•		•	•						•	•	•	•	•	•	•
1ZCS				•		•	•	•	•						•	•	•	•	•	•	•
1Z/1ZW				•		•		•													
10A				•			•	•													
10C		•		•			•	•					•								
10R/10RF + 10Q		•	•	•	•	•	•	•													

The RAL Codes mentioned are the codes nearest to the solid colors in the multimec™ range.

# Cap & Bezel Specifications

Multimec™ caps

ACCESSORY SPECIFICATIONS			
MATERIAL	PARTS	TEMP. LIMIT	UL RATING
ABS	Solid color 1A, 1B, 1DS, 1ES, 1FS, 1H, 1JS, 1KS, 1LS, 1M, 1NS, 1PS, 1QS, 1RS, 1TS, 1US, 1VS, 1WAS, 1WDS, 1WPS, 1XS, 1Z, 1ZA, 1ZB, 1ZCS, 1ZW, 10A, 10C, 10Q, 10R, 10RF and AQCS Bezels 2C, 2D and 2K, reflectors for 1KBS, 1KCS, 1YS and 1YAS	Max 65 °C Max 149 °F	UL94HB
Polycarbonate	All lenses and transparent colour caps, lids for 1KBS & 1KCS	Max 85 °C Max 185 °F	UL94HB
Polyamide	1GAS, 1GCS, 1SS and 2SS	Max 160 °C Max 320 °F	UL94V2
Legends adhesion	DS/EN ISO 2409 Class 1 & ASTM D3359 Class 4B		

# Multimec™ 5

High performance tactile switches •  
MIL-PRF-28855H • excellent illumination



## DISTINCTIVE FEATURES

- Large range of accessories
- Momentary switches with NO or NC/NO function
- Sealed to IP67
- Single or bi-color illumination option
- Illumination with integrated chip-LEDs



## ENVIRONMENTAL SPECIFICATIONS

- Sealing : IP67 according to IEC 60529
- Working and storage temperature :
  - non-illuminated : -40 °C/+160 °C (-40 °F to +320 °F)
  - illuminated : -30 °C/+85 °C (-22 °F to +185 °F)
- Soldering :
  - through-hole : IEC 60068-2-20 8
  - surface mount : JEDEC J-STD-020E



## ELECTRICAL SPECIFICATIONS

- Recommended load :
  - Gold contacts : 0.5µ-50 mA 24 VDC
  - Silver contacts : 0.5-50 mA 24 VDC
- Contact resistance : <30 mΩ - typically 10 mΩ
- Insulation resistance : >10 MΩ
- Contact bounce : <2 mS - typically 0.5 mS



## MECHANICAL SPECIFICATIONS

- Standard actuation force :
  - momentary NO : 2.0 N, 3.5 N, 6.5 N
  - quiet version : 2.0 N
  - NC/NO function : 3.5 N
- Max. actuation force :
  - momentary : 115 N for 60 sec (according to MIL-PRF-22885H)
  - NC/NO : 100 N for 10 sec
- Travel : 1 mm
- Lifetime :
  - NO : >10,000,000 cycles
  - NC/NO : >1,000,000 cycles

The company reserves the right to change specifications without notice.

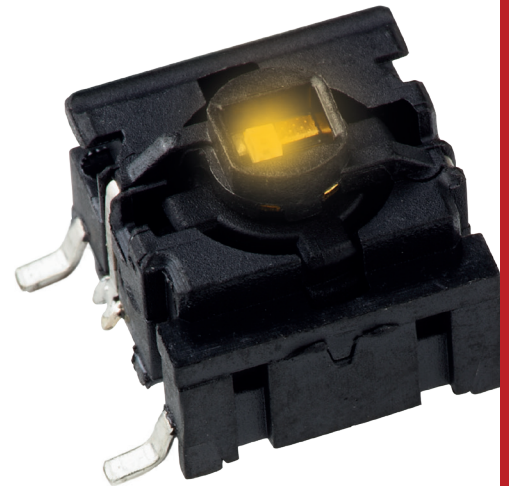

## MATERIALS

- Housing : PPS UL94V0
- Actuator : PPS UL94V0
- Sealing : Silicone rubber
- Contacts spring : Stainless steel
  - Silver : +3 µAg
  - Gold : +1 µAu
- Fixed contacts :
  - Silver : SnCu + 2 µNI + 3 µAg
  - Gold : SnCu + 2 µNI + 1 µAu
- Terminals : SnCu + 2 µNI + 3 µSn100

All tolerance if not otherwise specified ±0.2 mm.

# Multimec™ 5

High performance tactile switches • MIL-PRF-28855H • excellent illumination

## 5G NON-ILLUMINATED

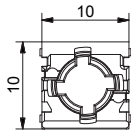

- SMD, TH or right angle TH
- NO or NC/NO

## 5G ILLUMINATED

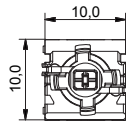

- SMD or TH
- NO
- single or bi-color LEDs

## 5E NON-ILLUMINATED

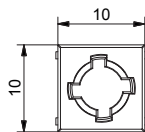

- SMD, TH or right angle TH
- NO or NC/NO

All tolerances unless otherwise noted : ±0.2 mm

## PCB LAYOUT & CIRCUIT DIAGRAM

Non-illuminated

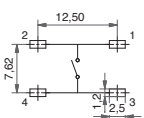
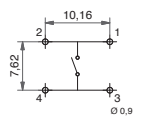

Single LED

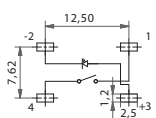
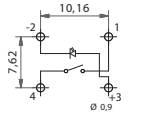

Bicolor - 2 LEDs

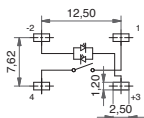
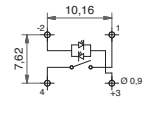

RAS

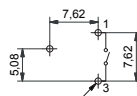

NC/NO function

\*not for sale in Japan

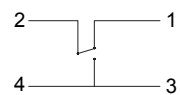

SMD

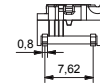
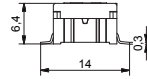

TH

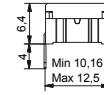

RAS

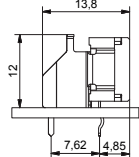
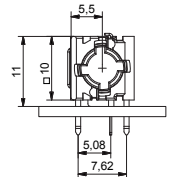

SMD

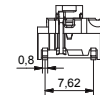
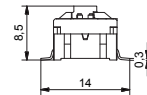

TH

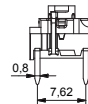
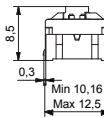

SMD

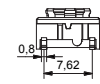
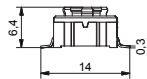

TH

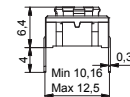

RAS

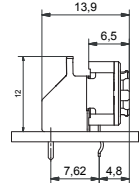
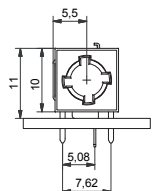



High performance tactile switches • MIL-PRF-28855H • excellent illumination



## BUILD YOUR PART NUMBER

**ILLUMINATED**

5G	—	—	—	—																																		
SERIES	MOUNTING	ACTUATION FORCE	LED	OPTIONAL																																		
	<table border="0"> <tr><td><b>TH9</b></td><td>through-hole</td></tr> <tr><td><b>SH9</b></td><td>surface mount</td></tr> </table>	<b>TH9</b>	through-hole	<b>SH9</b>	surface mount	<table border="0"> <tr><td><b>20</b></td><td>2.0N</td></tr> <tr><td><b>35</b></td><td>3.5N</td></tr> <tr><td><b>65</b></td><td>6.5N</td></tr> </table>	<b>20</b>	2.0N	<b>35</b>	3.5N	<b>65</b>	6.5N	<table border="0"> <tr><td><b>02</b></td><td>blue</td></tr> <tr><td><b>22</b></td><td>green</td></tr> <tr><td><b>29</b></td><td>high intensity green</td></tr> <tr><td><b>42</b></td><td>yellow</td></tr> <tr><td><b>61</b></td><td>white</td></tr> <tr><td><b>82</b></td><td>red</td></tr> <tr><td><b>2242</b></td><td>green/yellow</td></tr> <tr><td><b>8222</b></td><td>red/green</td></tr> <tr><td><b>8242</b></td><td>red/yellow</td></tr> </table>	<b>02</b>	blue	<b>22</b>	green	<b>29</b>	high intensity green	<b>42</b>	yellow	<b>61</b>	white	<b>82</b>	red	<b>2242</b>	green/yellow	<b>8222</b>	red/green	<b>8242</b>	red/yellow	<table border="0"> <tr><td><b>Q</b></td><td>quiet contact (with 2.0 N only)</td></tr> <tr><td><b>R</b></td><td>tape &amp; reel (with SMD only)</td></tr> <tr><td><b>G</b></td><td>gold contacts</td></tr> </table>	<b>Q</b>	quiet contact (with 2.0 N only)	<b>R</b>	tape & reel (with SMD only)	<b>G</b>	gold contacts
<b>TH9</b>	through-hole																																					
<b>SH9</b>	surface mount																																					
<b>20</b>	2.0N																																					
<b>35</b>	3.5N																																					
<b>65</b>	6.5N																																					
<b>02</b>	blue																																					
<b>22</b>	green																																					
<b>29</b>	high intensity green																																					
<b>42</b>	yellow																																					
<b>61</b>	white																																					
<b>82</b>	red																																					
<b>2242</b>	green/yellow																																					
<b>8222</b>	red/green																																					
<b>8242</b>	red/yellow																																					
<b>Q</b>	quiet contact (with 2.0 N only)																																					
<b>R</b>	tape & reel (with SMD only)																																					
<b>G</b>	gold contacts																																					

**NON-ILLUMINATED**

—	—	—	—																						
SERIES	MOUNTING	ACTUATION FORCE	OPTIONAL																						
<table border="0"> <tr><td><b>5E</b></td></tr> <tr><td><b>5G</b></td></tr> </table>	<b>5E</b>	<b>5G</b>	<table border="0"> <tr><td><b>TH9</b></td><td>through-hole</td></tr> <tr><td><b>SH9</b></td><td>surface mount</td></tr> </table>	<b>TH9</b>	through-hole	<b>SH9</b>	surface mount	<table border="0"> <tr><td><b>20</b></td><td>2.0N</td></tr> <tr><td><b>35</b></td><td>3.5N</td></tr> <tr><td><b>65</b></td><td>6.5N</td></tr> </table>	<b>20</b>	2.0N	<b>35</b>	3.5N	<b>65</b>	6.5N	<table border="0"> <tr><td><b>Q</b></td><td>quiet contact (with 2.0 N only)</td></tr> <tr><td><b>RAS</b></td><td>right angle (with TH only)</td></tr> <tr><td><b>NCNO</b></td><td>normally closed/ normally open function (with 3.5 N only)</td></tr> <tr><td><b>R</b></td><td>tape &amp; reel (with SMD only)</td></tr> <tr><td><b>G</b></td><td>gold contacts</td></tr> </table>	<b>Q</b>	quiet contact (with 2.0 N only)	<b>RAS</b>	right angle (with TH only)	<b>NCNO</b>	normally closed/ normally open function (with 3.5 N only)	<b>R</b>	tape & reel (with SMD only)	<b>G</b>	gold contacts
<b>5E</b>																									
<b>5G</b>																									
<b>TH9</b>	through-hole																								
<b>SH9</b>	surface mount																								
<b>20</b>	2.0N																								
<b>35</b>	3.5N																								
<b>65</b>	6.5N																								
<b>Q</b>	quiet contact (with 2.0 N only)																								
<b>RAS</b>	right angle (with TH only)																								
<b>NCNO</b>	normally closed/ normally open function (with 3.5 N only)																								
<b>R</b>	tape & reel (with SMD only)																								
<b>G</b>	gold contacts																								



## ABOUT THIS SERIES

- ⌚ Marking on the switch for identification : WWYS, WW=week, Y=year, S=suffix for the type of switch, e.g. P=2.0 N and silver contacts, S=3.5 N and silver contacts, E6.5 N and silver contacts
- ⚙ Caps and accessories : for the full range of accessories for Multimec™ 5 series please see the website.

# Multimec™ 5

High performance tactile switches •  
MIL-PRF-28855H • excellent illumination



## TAPE & REEL

Tape and reel is available for the parts listed and has the following specifications

- Reel diameter: Ø330 mm
- Tape width: 24 mm
- Pitch: see list
- Tape and reel material: antistatic or better
- Quantity per reel: see list

PART NO.	ORDERING CODE	PITCH	QUANTITY PER REEL
5XSH9XX	5XSH9XXR	16	500
5XSH9XX1SSXX-08.0	5XSH9XXR1SSXX-08.0	20	250
5XSH9XX1SSXX-09.5	5XSH9XXR1SSXX-09.5	20	250
5XSH9XX1SSXX-10.4	5XSH9XXR1SSXX-10.4	20	250
5XSH9XX1SSXX-11.0	5XSH9XXR1SSXX-11.0	20	250
5XSH9XX1SSXX-12.0	5XSH9XXR1SSXX-12.0	20	250
5GSH9XX02	5GSH9XX02R	20	250
5GSH9XX22	5GSH9XX22R	20	250
5GSH9XX42	5GSH9XX42R	20	250
5GSH9XX61	5GSH9XX61R	20	250
5GSH9XX82	5GSH9XX82R	20	250
5GSH9XX2242	5GSH9XX2242R	20	250
5GSH9XX8222	5GSH9XX8222R	20	250
5GSH9XX8242	5GSH9XX8242R	20	250



## OPERATING FORCE

2.0 N

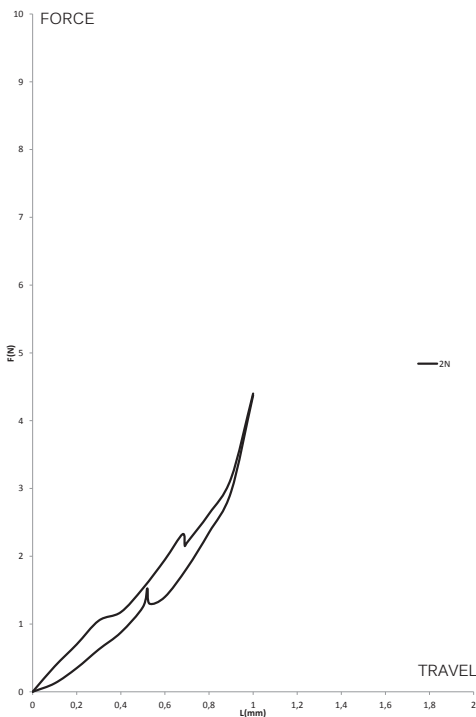

3.5 N

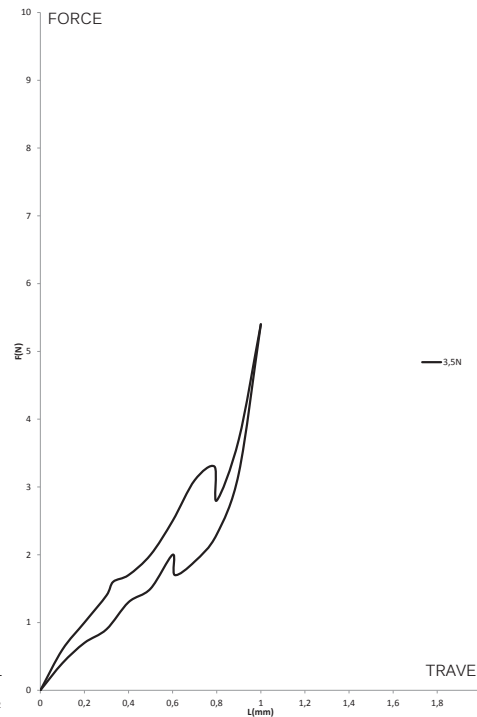

6.5 N

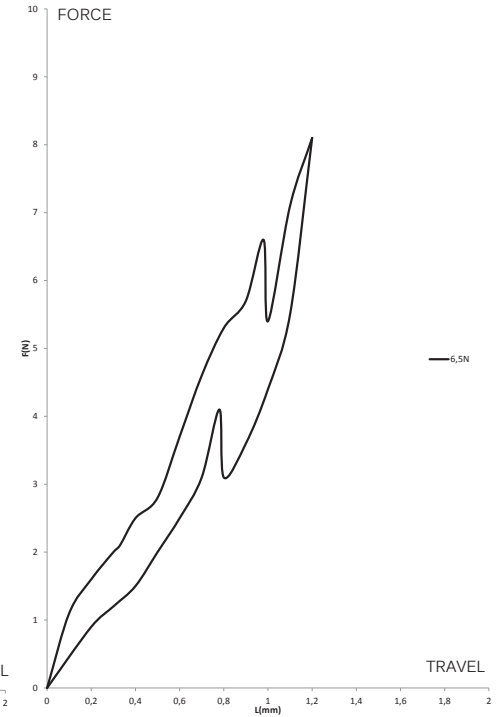

# Multimec™ 5

High performance tactile switches • MIL-PRF-28855H • excellent illumination



## MOUNTING

MOUNTING TOOLS FOR MULTIMEC® THROUGH-HOLE SWITCHES

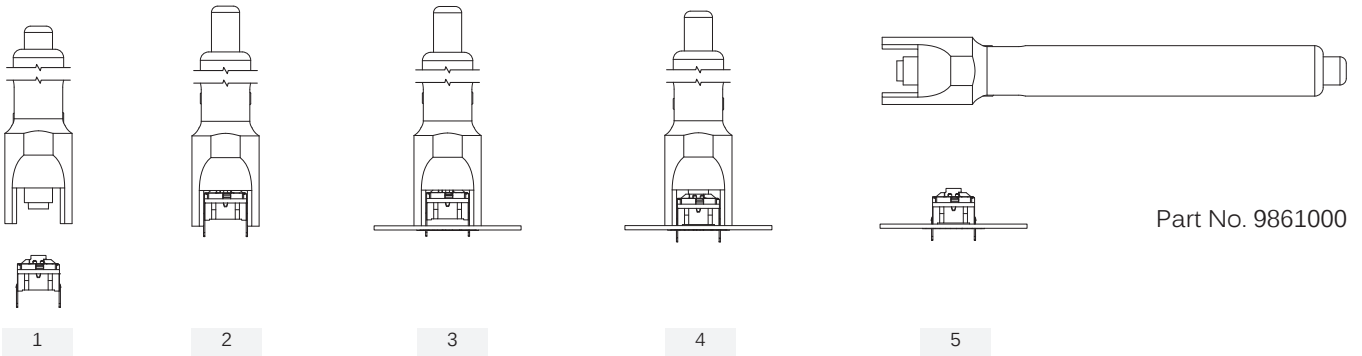

SPACE REQUIREMENT - MATRIX MOUNTING

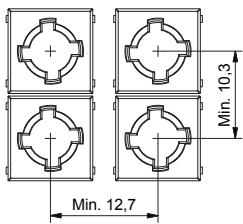

Through-hole (TH)

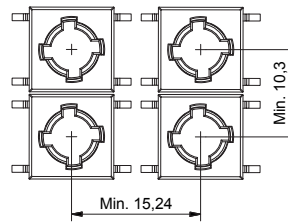

Surface mount (SMD)

MULTIMEC® SPACING EXAMPLES

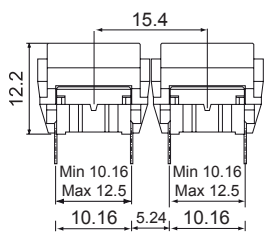

5GT+1B/C+2C/D

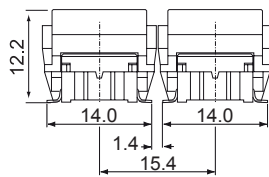

5GS+1B/C+2C/D

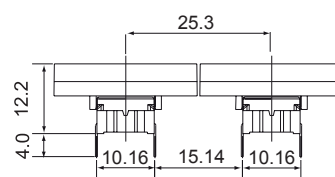

5GT+1A/H

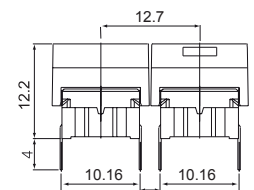

5GT+1M

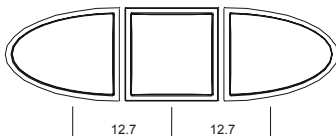

1VS+1TS+1VS

# Multimec™ 5

High performance tactile switches •  
MIL-PRF-28855H • excellent illumination



## MOUNTING (CONTINUED)

SPACE REQUIREMENT - SWITCH/CAP

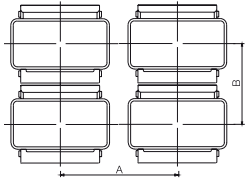

Switch spacing

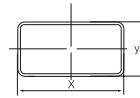

Cap dimensions

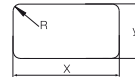

Panel cut-out

CAP SERIES	RECOMMENDED MIN. SWITCH SPACING AxB	NOMINAL CAP DIMENSION WxH	RECOMMENDED MIN. PANEL CUT-CUT
1A/1H	12.7x10.3	12.6x10.1	13.0x10.5
1B+2C/2D	15.4x15.4	15.1x15.1	15.5x15.5
1DS/1ES/1FS	12.7x11.3	Ø9.6	Ø10
1GAS	12.7x11.3	Ø11.0	Ø11.4
1GCS	15.3x15.3	Ø15.0	Ø15.4
1JS	12.7x10.3	Ø10.0	Ø10.4
1KS/1KBS/1KCS	14.6x14.6	14.3x14.3	14.7x14.7
1M	25.3x10.3	25.0x10.0	25.7x10.5
1NS	13.6x11.3	Ø9.8/ □4.9	Ø10.2/□5.1
1PS/ 1QS/1RS	12.8x10.3	6.5x12.5	7.0x13.0, R max. 1.0
1SS/1IS/1LS	12.7x10.3	Ø6.5	Ø7.0
1TS	12.7x12.3	10.6x10.6	11.0x11.0
1US	12.7x12.3	Ø10.6	Ø11.0
1VS	15.95x12.1	10.6x13.25	11.0x13.65
1WAS/1WPS	14.2x10.3	12.5x6.5	12.9x6.9
1WDS	16.9x10.3	15.2x8.0	15.6x8.4
1XS	12.7x10.3	9.4x7.4	9.8x7.9
1YS/1YAS	15.3x15.3	15x15	16x16
1ZA	19.0x10.3	18.7x10.1	19.4x10.5
1ZB	24.34x12.1	R1=7.4; R2=17.5 90°	R1=7.1; R2=17.5-17.75 90°
1ZCS	14.6x14.6	Ø14.3	Ø14.7
1Z/1ZW	35.5x35.5; 41.6x41.6	Ø29.5	Ø30.3
10A	22.0x40.0	R=5.3; 10.6x28	R=5.5; 11x28.4
10C	22.3x22.3	Ø19.2	Ø19.8
10R/10RF/10RM	37.3x37.3	Ø30.0	Ø30.6
10Q/10QM	29.3x29.3	22.0x22.0	22.5x22.5



## LED COMPONENT SPECIFICATIONS

LED COMPONENT SPECIFICATIONS							
Color		Blue	Green	Yellow	White	Red	High Intensity Green
Color Codes		02	22	42	61	82	29
ABSOLUTE MAXIMUM RATINGS (Ta= 25°C)							
Power	mW	75	75	60	46.5	65	102.5
Current forward	mA	20	30	25	15	25	25
Forward peak current	mA	100	80	60	100	100	150
Voltage reverse	V	5	5	5	5	12	5
Operating temperature	°C	-40/+85	-55/+85	-40/+85	-40/+85	-30/+85	-40/+85
Storage temperature	°C	-40/+90	-55/+85	-40/+90	-40/+85	-40/+85	-40/+85
Soldering temperature	°C	245 for max 10 sec					
ELECTRICAL-OPTICAL CHARACTERISTICS (Ta=25 °C)							
Voltage forward	Typ. V	2.7	2	1.75**	2.85	2	3.3
	Max. V	3.7	2.4	2.35	3.1	2.5	4.1
Current reverse (VR=5V)	Max. µA	50	100	10	10	100	50
Wave length	nm	468	571	591	NA	633	525
Spread	Δnm	25	NA	15	NA	16	30
Spread angle	degree	120	130	120	150	160	60
Luminous Intensity	Min. mcd	45	18	28.5	56	28	500
	Typ. mcd	122*	35	72*	max 450*	max 180*	1000
Optical intensity	Lm/w	NA	NA	NA	36	7	NA

\*F=20 mA, \*\*Pulse width 1ms Duty cycle 1:5, \*\*\*F=50 mA, \*\*\*\*Luminous Flux mlm

# Multimec™ 5

High performance tactile switches • MIL-PRF-28855H • excellent illumination



## USAGE GUIDELINES

### HOW TO GET THE BEST RESULTS WITH MEC SWITCHES ?

These guidelines are offered to users of MEC Switches as an aid to ensure successful and reliable switch operation. Please see the technical specifications for details on operating and storage temperatures and soldering guidelines to make sure you select the best switch for your application. When reflow soldering is taking place, MEC strongly recommend that the temperature profile is analyzed and compared with the temperature rating of the switch. It is also important to monitor the accumulated heat buildup from both the pre-heat zones and the solder zone.

Most standard accessories for multimec™ 5 series switches are made from ABS plastic with a maximum operating temperature of 65 °C. It is strongly recommended that accessories are mounted after soldering of the switch. If this is not possible care must be taken not to overheat the accessories during the soldering process. The 1SS and 1GAS/1GCS caps are, however, made of high temperature materials and will meet the same temperature specifications as the switches. For accessories made from other plastic materials please see multimec™ 5 series cap & accessories technical specifications.

LEDs have their own temperature specifications. When fitted in a switch the LED will determine the max. operating temperature, i.e. 5GTH93522 has an upper temperature limit of 85 °C!

### MOUNTING AND DISMOUNTING

If switches are to be mounted in rows it is essential that the recommendations regarding spacing are followed. PC board thickness should be 1.4 ±0.2 mm and terminal hole diameter should be 0.9 mm.

All multimec™ 5 series caps and bezels are easily snapped onto the switch modules and can be changed at a later time.

A mounting tool is available for through hole multimec™ 5 series switches.

### SOLDERING AND CLEANING MULTIMEC™ SERIES

Multimec™ 5 series switches are fully sealed to IP67 specifications to minimize solder flux and aqueous based cleaning solutions from entering the switch and contaminating the contacts. The switches can be placed on the PC board with other components and reflow soldered. Multimec™ 5 series offers a high level of sealing, however, with aqueous solvent solutions care must be taken to avoid the worst

case situation with water jets, complete immersion into a liquid with a temperature below the board or surface tension reducing additives.

Recommended cleaning methods are demineralized water. Any surface tension reducing agents, such as soap, must not be used as they risk causing a potential leakage of the switch.

### SOLDERING - THROUGH HOLE VERSIONS

**Hand soldering:** max. 350 °C for max. 3 sec

**Wave soldering:** heat built up in the switch during pre-heating and soldering must not exceed the maximum operating temperature of the switch. Peak temperature must not exceed 260 °C, and soldering time is max 10 sec. (IEC 60068-2-20 8)

### SOLDERING - SURFACE MOUNT VERSIONS

For all methods - infrared, convection and vapor phase. The upper limit 240 °C/40 sec must be observed. The soldering temperature profile must have moderate temperature gradients. (JEDEC J-STD-020E)

### ROHS COMPLIANCE

As of 1 July 2006 MEC has completed the conversion to RoHS compliance. For more info please see our homepage [www.apem.com](http://www.apem.com)

### TEMPERATURE LIMITS:

Switch	160 °C
LEDs	85/90 °C
Accessories	65/85/160 °C

### PACKAGING

Multimec™ 5 series switches are packed in rigid tubes of 50 pieces each.

A box contains 1.000 pcs.

The surface mount versions of multimec™ 5 series switches with a height up to 12.5 mm can also be delivered on tape/reel. Each reel contains 250/500 pcs.