

Q8 series

Ø8 mm panel mount LED indicators



DISTINCTIVE FEATURES

5mm colored diffused epoxy lens or 5 mm water clear super bright LEDs

Prominent, recessed and flush bezel styles

(2.8 x 0.8) solder lug/faston terminals, pins or (200 mm long) wire terminations (2.0 x 0.5) solder lug/faston terminals on tri-color versions



ENVIRONMENTAL SPECIFICATIONS

- IP67 sealing option (EN60529)
- Operating & Storage Temperature Range:
Rear plastic body: -30 °C to +65 °C (-22 °F to +149 °F)
Rear epoxy body: -40 °C to +85 °C (-40 °F to +185 °F)



GENERAL SPECIFICATIONS

- Max Reverse Voltage: 5 V
- Viewing Angle: 30–100° (dependant on model)
- Life Expectancy: 100,000 hours
- Torque: 20 to 25 cNm
- Maximum panel thickness 7 mm



MATERIALS

- Plated brass bezel finished in bright chrome, black or satin grey and moulded polycarbonate rear body



MOUNTING

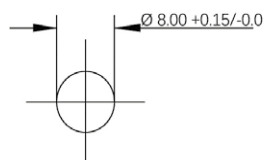
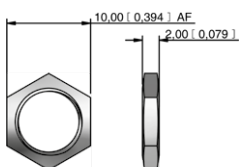

The company reserves the right to change specifications without notice.

All LED characteristics are dependent upon environmental conditions. Therefore published data should be considered nominal and subject to variations.



Q8 series

Ø8 mm panel mount LED indicators



ELECTRICAL SPECIFICATIONS

STANDARD LED INTENSITY

| LED COMPONENT SPECIFICATIONS | | | |
|--|------------------------|-------------|-------------------|
| | Prominent and Recessed | Flush | Forward Voltage |
| HE Red | 80 mcd | 8 mcd | 2.0 V |
| Green | 60 mcd | 6 mcd | 2.2 V |
| Yellow | 50 mcd | 6 mcd | 2.1 V |
| Blue | 1,600 mcd | 50 mcd | 3.3 V |
| White | 1,600 mcd | 500 mcd | 3.3 V |
| Orange | 60 mcd | 110 mcd | 2.2 V |
| Bi-color (Typical) (Red/Green) | 14/30 mcd | 15/10 mcd | 2.0V/2.2 V |
| Tri-color (Typical) (Red/Green/Yellow) | 60/15/13 mcd | 15/10/6 mcd | 2.0 V/2.2 V/2.1 V |

Bi-color - The color is changed by reversing the polarity of the supply voltage.
Tri-color - The indicator has red and green LEDs, when both connected yellow is produced.

SUPER BRIGHT LED INTENSITY

| LED COMPONENT SPECIFICATIONS | | | |
|------------------------------|------------------------|-----------|-----------------|
| | Prominent and Recessed | Flush | Forward Voltage |
| HE Red | 5,000 mcd | 1,300 mcd | 2.2 V |
| Green | 10,000 mcd | 1,200 mcd | 3.3 V |
| Yellow | 4,000 mcd | 350 mcd | 2.0 V |
| Blue | 2,200 mcd | 280 mcd | 3.3 V |
| White | 2,500 mcd | 950 mcd | 3.3 V |
| Orange | 4,000 mcd | 500 mcd | 2.2 V |

HYPER BRIGHT LED INTENSITY

| LED COMPONENT SPECIFICATIONS | | | |
|------------------------------|------------------------|---------|-----------------|
| | Prominent and Recessed | Flush | Forward Voltage |
| HE Red | 6,000 mcd | 980 mcd | 2.2 V |
| Green | 1,900 mcd | 300 mcd | 3.3 V |
| Yellow | 1,600 mcd | 250 mcd | 2.0 V |
| Orange | 2,400 mcd | 110 mcd | 2.2 V |









- The operating voltage must not be exceeded by more than 10% as this will result in reduced life expectancy
- Luminous intensity is measured at 20 mA on a discrete led unless otherwise stated.
- Luminous intensities and color shades of white LEDs may vary within a batch.
- Luminous intensity will be reduced with lower operating current.

| Voltage | Operating Voltage | Operating Current |
|-------------------|-------------------|---------------------|
| | (Min to Max) | (Typical All Types) |
| 02 (No Resistor)* | 1.8 to 3.3 VDC | 20 mA max |
| 6 VDC | 5.4 to 6.6 VDC | 20 mA |
| 12 VDC | 10.8 to 13.2 VDC | 20 mA |
| 24 VDC | 21.6 to 26.4 VDC | 20 mA |
| 28 VDC | 25.2 to 30.8 VDC | 20 mA |
| 110 VAC | 99 to 121 VAC | 6 mA |
| 220 VAC | 207 to 235 VAC | 3 mA |

* Customer to supply resistor for desired operating current.



BUILD YOUR PART NUMBER

| | | | | |
|--|--|--|---|--|
|  Q SERIES |  8 Ø8 mm MOUNTING HOLE |  P Prominent R Recessed F Flush BEZEL STYLE |  1 Solder Lug/ Fastons (2.8 x 0.8) 2 Pins 3 Wires 4 Rear epoxy Pins 5 Rear epoxy Wires 6 Short body Pins 7 Short body Wires 8 Short body Lug/ Fastons (2.8 x 0.8) 9 Extended short body solder Lug/ Fastons (2.8 x 0.5) TERMINALS |  C Bright Chrome B Black G Satin Grey BEZEL FINISH |
|  XX Fixed Light KK Flashing Light (12V – 28VDC) YY Bi-color ZZ Tri-color TYPE OF ILLUMINATION |  R Red G Green Y Yellow B Blue W White O Orange HR Hyper Bright Red HG Hyper Bright Green HY Hyper Bright Yellow HO Hyper Bright Orange SR Super Bright Red SG Super Bright Green SY Super Bright Yellow SB Super Bright Blue LED COLOR |  SW Super Bright White SO Super Bright Orange RG Red/Green RY Red/Yellow GY Green/Yellow RYG Red/Yellow/Green VOLTAGE |  02 no resistor* 06 6 VDC 12 12 VDC 12A 12 VAC/DC 24 24 VDC 24A 24 VAC/DC 28 28 VDC 28A 28 VAC/DC 110 110 VAC 220 220 VAC (Blank) Unsealed E IP67 SEALING | |



ABOUT THIS SERIES

- Notice:** please note that not all combinations of above numbers are available.
- Gold faston terminal denotes anode (+), silver terminal denotes cathode (-)
 - Standard wire length is 200 mm, 24 AWG UL1061, red wire denotes anode (+), black wire denotes cathode (-) for other wire lengths consult APEM
 - 110 VAC and 220 VAC, only available with terminal options 1 & 3
 - Bi-color leds, by connecting the gold faston (+) one color is produced, by reversing the supply voltage another color is produced – bi-colors are available up to 28 VDC [AC products not available]
 - Take care when soldering to the faston terminals (recommended solder temperature 300 °C - 3 sec)
 - Terminal options 2,6,7 & 9 are only available up to 28 V (DC only). Tri-color not available with terminal 9
 - Terminal code 8 is only available without integral resistor, see forward voltage values.
 - We recommend using hyperbright or superbright leds for use at 110 VAC and 220 VAC
 - Mains voltage product is not recommended for use on 3 phase appliances
 - The tri-color led has red and green leds when both are connected yellow is produced
 - Standard tri-color faston terminals are two anodes (+) and one cathode (-)
 - Tri-color wires are one red (+) and one green (+) anode and one black (-) cathode
 - Tri-color pins are center (-) cathode, shortest (+) anode pin green, longest (+) anode pin red

Q8 series

Ø8 mm panel mount LED indicators

PROMINENT BEZEL



WIRES

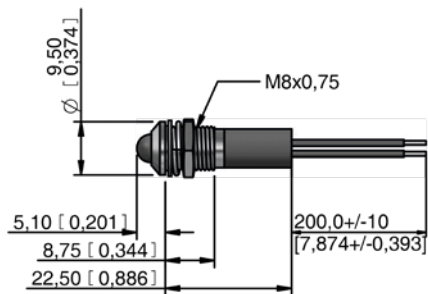

REAR EPOXY WIRES

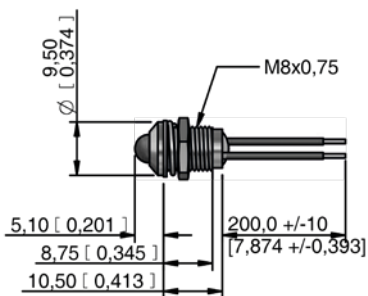

SHORT BODY WIRES

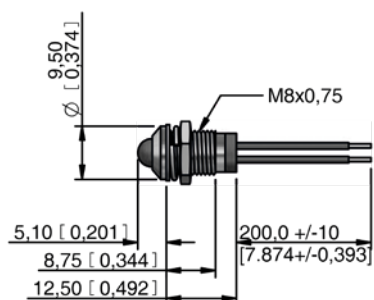

SOLDER LUG/FASTON

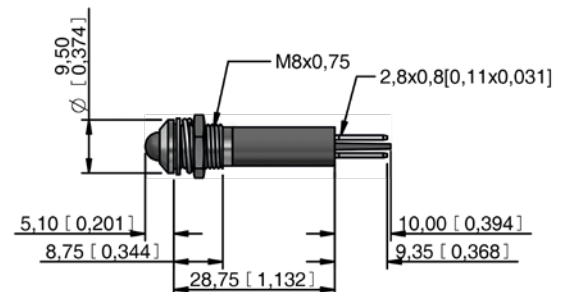

PINS

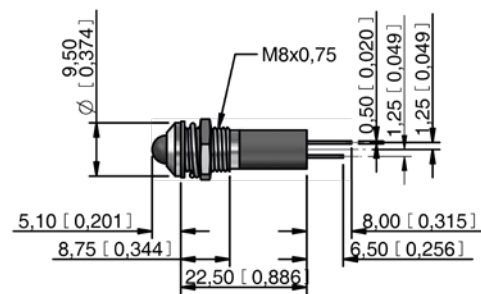

REAR EPOXY PINS

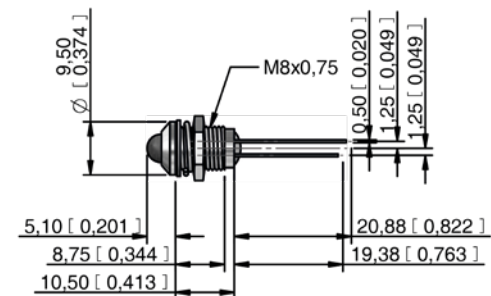

SHORT BODY PINS

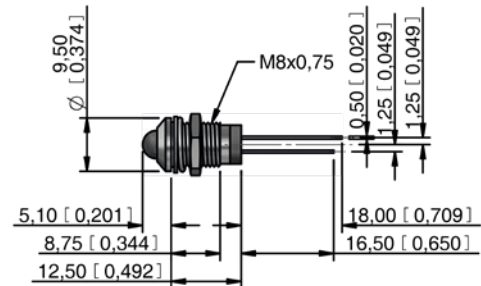

PROMINENT BEZEL (CONTINUED) SHORT BODY SOLDER LUG/FASTONS

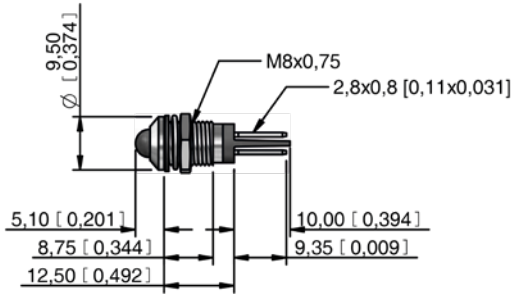

EXTENDED SHORT BODY SOLDER LUG/FASTONS

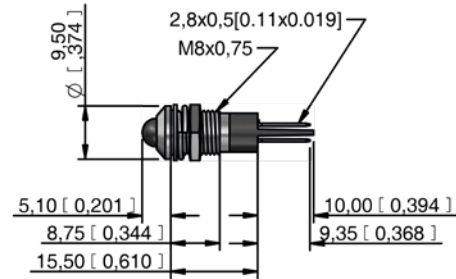

FLUSH BEZEL



SOLDER LUG/FASTON

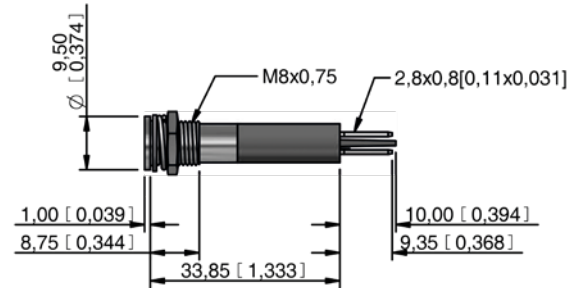

WIRES

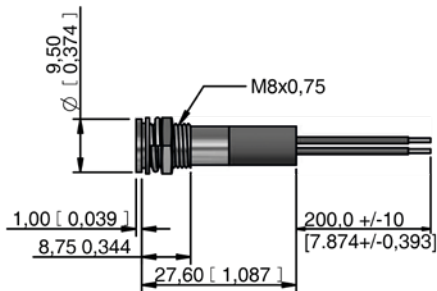

PINS

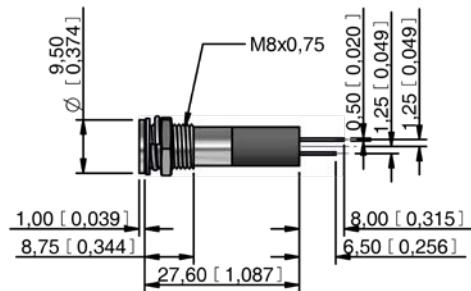

REAR EPOXY WIRES

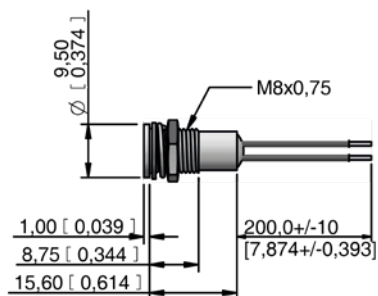

REAR EPOXY PINS

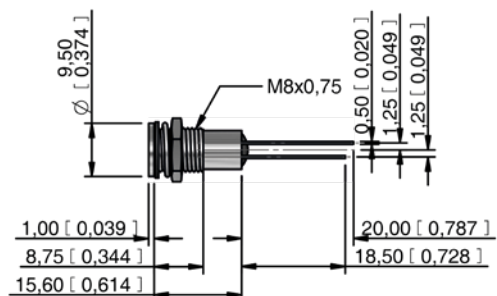

Q8 series

Ø8 mm panel mount LED indicators

FLUSH BEZEL (CONTINUED)

SHORT BODY WIRES

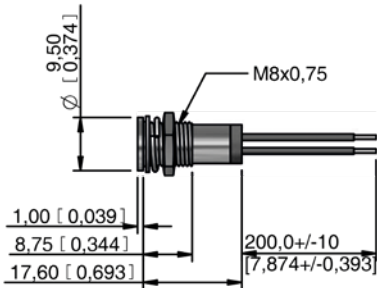

SHORT BODY PINS

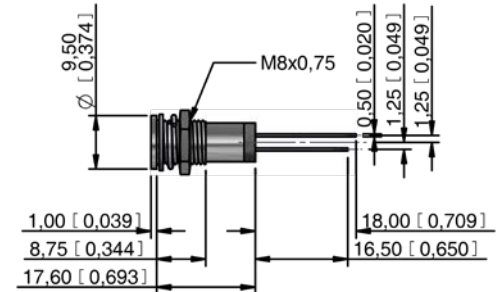

SHORT BODY SOLDER LUG/FASTONS

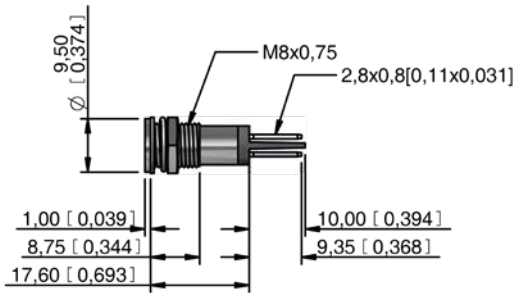

EXTENDED SHORT BODY SOLDER LUG/FASTONS

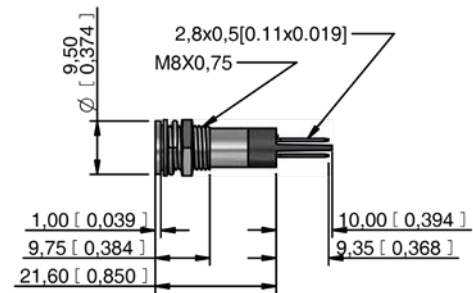

RECESSED BEZEL



SOLDER LUG/FASTON

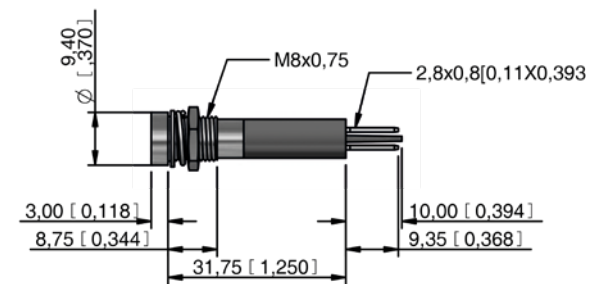

WIRES

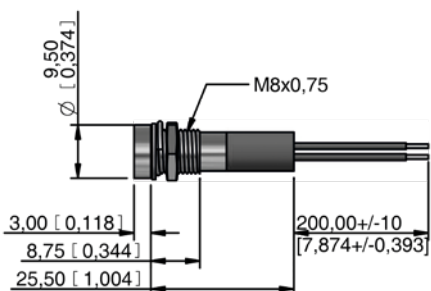

PINS

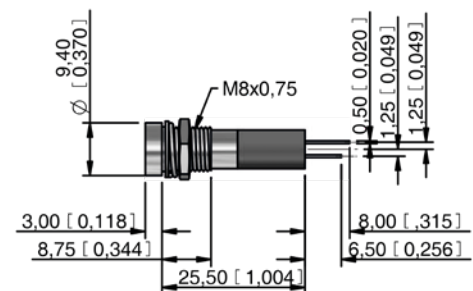

RECESSED BEZEL (CONTINUED)

REAR EPOXY WIRES

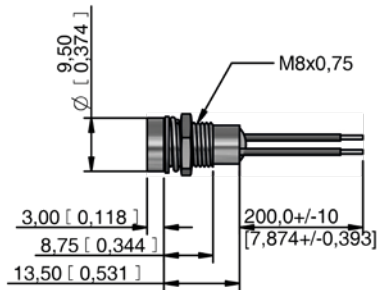

SHORT BODY WIRES

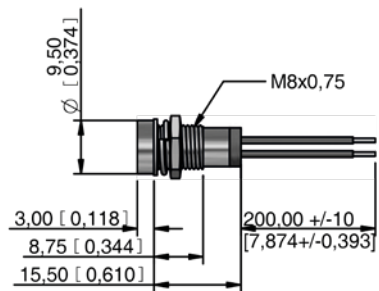

SHORT BODY SOLDER LUG/FASTONS

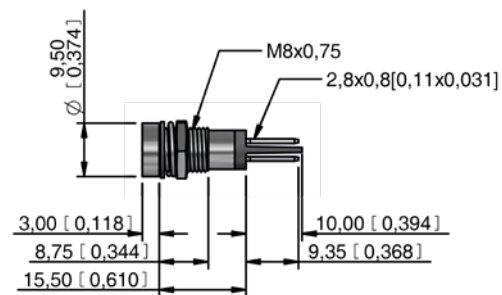

REAR EPOXY PINS

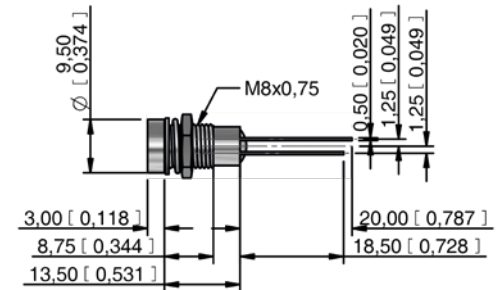

SHORT BODY PINS

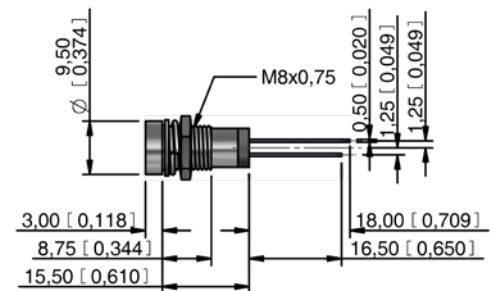

EXTENDED SHORT BODY SOLDER LUG/FASTONS

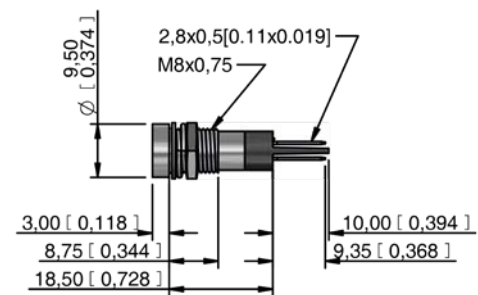

Mouser Electronics

Authorized Distributor

Click to View Pricing, Inventory, Delivery & Lifecycle Information:

Apem:

[Q8F1BXXB110E](#) [Q8F1BXXB12E](#) [Q8F1BXXB24E](#) [Q8F1BXXG110E](#) [Q8F1BXXG12E](#) [Q8F1BXXG24E](#)
[Q8F1BXXR110E](#) [Q8F1BXXR12E](#) [Q8F1BXXR24E](#) [Q8F1BXXW110E](#) [Q8F1BXXW12E](#) [Q8F1BXXW24E](#)
[Q8F1BXXY110E](#) [Q8F1BXXY12E](#) [Q8F1BXXY24E](#) [Q8F7BXXR02E](#) [Q8P3BXXG02](#) [Q8P3BXXG24](#) [Q8P3BXXR24](#)
[Q8P7BXXR12E-SP](#) [Q8P1CXXSR110](#) [Q8P1CXXSG110](#) [311 Q8F8BXXSG02E](#) [Q8P3BXXY12E](#) [Q8F7BXXG24E](#)
[Q8F3BXXR24E](#) [Q8P7BXXG02E](#) [Q8P3BXXG12E](#) [Q8F3BXXG12E](#) [Q8F3CXXB12E](#) [Q8F7BXXG02E](#)
[Q8F3BZZRYG12E](#) [Q8F3CXXR24E](#) [Q8F3BXXB24E](#) [Q8F3CXXG12E](#) [Q8F3CXXR12E](#) [Q8F3CXXW24E](#)
[Q8F3CXXG24E](#) [Q8F3BXXR12E](#) [Q8P3BXXY24E](#) [Q8F1BXXG02E](#) [Q8P7CZZRYG02E](#) [Q8F1BZZRYG12E](#)
[Q8F1BXXB24EX0238](#) [Q8F3BXXG02E](#) [Q8P7CXXSB12E](#) [Q8F1BXXSG110E](#) [Q8F1BXXY02E](#) [Q8F1BXXR02E](#)
[Q8F3BXXSY220E](#) [Q8P6BYYRG28E](#) [Q8P1BXXG28E](#) [Q8P1BXXY28E](#) [Q8P1BXXR28E](#) [Q8F3BXXW24E](#)
[Q8F1BXXR28](#) [Q8R5BZZRYG02E](#) [Q8R5GZZRYG02E](#) [Q8F1BXXR28E](#) [Q8F3BXXR24AE](#) [Q8F3BXXG24AE](#)
[Q8F3BXXSG220E](#) [Q8F3BXXG24](#)