

XPT™ 600V IGBT
GenX3™
IXXH100N60C3

$$V_{CES} = 600V$$

$$I_{C110} = 100A$$

$$V_{CE(sat)} \leq 2.20V$$

$$t_{fi(typ)} = 75ns$$

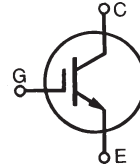
 Extreme Light Punch Through
 IGBT for 20-60kHz Switching

TO-247 AD

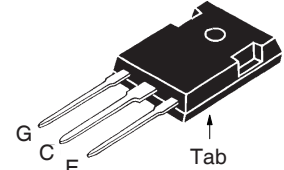
 G = Gate C = Collector
 E = Emitter Tab = Collector

Symbol	Test Conditions	Maximum Ratings	
V_{CES}	$T_J = 25^\circ\text{C}$ to 175°C	600	V
V_{CGR}	$T_J = 25^\circ\text{C}$ to 175°C , $R_{GE} = 1M\Omega$	600	V
V_{GES}	Continuous	± 20	V
V_{GEM}	Transient	± 30	V
I_{C25}	$T_C = 25^\circ\text{C}$ (Chip Capability)	190	A
I_{LRMS}	Terminal Current Limit	160	A
I_{C110}	$T_C = 110^\circ\text{C}$	100	A
I_{CM}	$T_C = 25^\circ\text{C}$, 1ms	380	A
I_A	$T_C = 25^\circ\text{C}$	50	A
E_{AS}	$T_C = 25^\circ\text{C}$	600	mJ
SSOA (RBSOA)	$V_{GE} = 15V$, $T_{VJ} = 150^\circ\text{C}$, $R_G = 2\Omega$ Clamped Inductive Load	$I_{CM} = 200$ @ $V_{CE} \leq V_{CES}$	A
t_{sc} (SCSOA)	$V_{GE} = 15V$, $V_{CE} = 360V$, $T_J = 150^\circ\text{C}$ $R_G = 10\Omega$, Non Repetitive	10	μs
P_C	$T_C = 25^\circ\text{C}$	830	W
T_J		-55 ... +175	$^\circ\text{C}$
T_{JM}		175	$^\circ\text{C}$
T_{stg}		-55 ... +175	$^\circ\text{C}$
T_L	Maximum Lead Temperature for Soldering	300	$^\circ\text{C}$
T_{SOLD}	1.6 mm (0.062in.) from Case for 10s	260	$^\circ\text{C}$
M_d	Mounting Torque	1.13/10	Nm/lb.in.
Weight		6	g

Features

- Optimized for 20-60kHz Switching
- Square RBSOA
- Avalanche Rated
- Short Circuit Capability
- High Current Handling Capability
- International Standard Package

Advantages

- High Power Density
- Low Gate Drive Requirement

Applications

- Power Inverters
- UPS
- Motor Drives
- SMPS
- PFC Circuits
- Battery Chargers
- Welding Machines
- Lamp Ballasts

Symbol	Test Conditions ($T_J = 25^\circ\text{C}$, Unless Otherwise Specified)	Characteristic Values		
		Min.	Typ.	Max.
BV_{CES}	$I_C = 250\mu\text{A}$, $V_{GE} = 0V$	600		V
$V_{GE(th)}$	$I_C = 250\mu\text{A}$, $V_{CE} = V_{GE}$	3.0		5.5 V
I_{CES}	$V_{CE} = V_{CES}$, $V_{GE} = 0V$ $T_J = 150^\circ\text{C}$			25 μA 2 mA
I_{GES}	$V_{CE} = 0V$, $V_{GE} = \pm 20V$			± 100 nA
$V_{CE(sat)}$	$I_C = 70A$, $V_{GE} = 15V$, Note 1 $T_J = 150^\circ\text{C}$	1.68 1.97		2.20 V V

Symbol Test Conditions ($T_J = 25^\circ\text{C}$ Unless Otherwise Specified)		Characteristic Values		
		Min.	Typ.	Max.
g_{fs}	$I_C = 60\text{A}, V_{CE} = 10\text{V}, \text{Note 1}$	22	40	S
C_{ies}	$V_{CE} = 25\text{V}, V_{GE} = 0\text{V}, f = 1\text{MHz}$		4810	pF
C_{oes}			275	pF
C_{res}			80	pF
$Q_{g(on)}$	$I_C = 70\text{A}, V_{GE} = 15\text{V}, V_{CE} = 0.5 \cdot V_{CES}$		150	nC
Q_{ge}			34	nC
Q_{gc}			60	nC
$t_{d(on)}$	Inductive load, $T_J = 25^\circ\text{C}$ $I_C = 70\text{A}, V_{GE} = 15\text{V}$ $V_{CE} = 360\text{V}, R_G = 2\Omega$ Note 2		30	ns
t_{ri}			70	ns
E_{on}			2.00	mJ
$t_{d(off)}$			90	ns
t_{fi}			75	ns
E_{off}		0.95	1.40	mJ
$t_{d(on)}$	Inductive load, $T_J = 150^\circ\text{C}$ $I_C = 70\text{A}, V_{GE} = 15\text{V}$ $V_{CE} = 360\text{V}, R_G = 2\Omega$ Note 2		30	ns
t_{ri}			65	ns
E_{on}			3.00	mJ
$t_{d(off)}$			105	ns
t_{fi}			115	ns
E_{off}		1.40	mJ	
R_{thJC}			0.18	$^\circ\text{C/W}$
R_{thCS}		0.15		$^\circ\text{C/W}$

TO-247 (IXXH) Outline

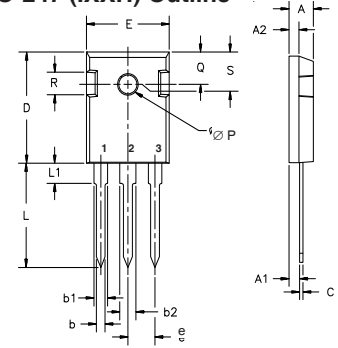

Terminals: 1 - Gate 2 - Collector
3 - Emitted

Dim.	Millimeter		Inches	
	Min.	Max.	Min.	Max.
A	4.7	5.3	.185	.209
A ₁	2.2	2.54	.087	.102
A ₂	2.2	2.6	.059	.098
b	1.0	1.4	.040	.055
b ₁	1.65	2.13	.065	.084
b ₂	2.87	3.12	.113	.123
C	.4	.8	.016	.031
D	20.80	21.46	.819	.845
E	15.75	16.26	.610	.640
e	5.20	5.72	0.205	0.225
L	19.81	20.32	.780	.800
L ₁		4.50		.177
∅P	3.55	3.65	.140	.144
Q	5.89	6.40	0.232	0.252
R	4.32	5.49	.170	.216
S	6.15	BSC	242	BSC

Notes:

1. Pulse test, $t \leq 300\mu\text{s}$, duty cycle, $d \leq 2\%$.
2. Switching times & energy losses may increase for higher V_{CE} (clamp), T_J or R_G .

PRELIMINARY TECHNICAL INFORMATION

The product presented herein is under development. The Technical Specifications offered are derived from a subjective evaluation of the design, based upon prior knowledge and experience, and constitute a "considered reflection" of the anticipated result. IXYS reserves the right to change limits, test conditions, and dimensions without notice.

IXYS Reserves the Right to Change Limits, Test Conditions, and Dimensions.

IXYS MOSFETs and IGBTs are covered by one or more of the following U.S. patents:	4,835,592	4,931,844	5,049,961	5,237,481	6,162,665	6,404,065 B1	6,683,344	6,727,585	7,005,734 B2	7,157,338B2
	4,860,072	5,017,508	5,063,307	5,381,025	6,259,123 B1	6,534,343	6,710,405 B2	6,759,692	7,063,975 B2	
	4,881,106	5,034,796	5,187,117	5,486,715	6,306,728 B1	6,583,505	6,710,463	6,771,478 B2	7,071,537	

Fig. 1. Output Characteristics @ $T_J = 25^\circ\text{C}$

Fig. 2. Extended Output Characteristics @ $T_J = 25^\circ\text{C}$

Fig. 3. Output Characteristics @ $T_J = 150^\circ\text{C}$

Fig. 4. Dependence of $V_{CE(sat)}$ on Junction Temperature

Fig. 5. Collector-to-Emitter Voltage vs. Gate-to-Emitter Voltage

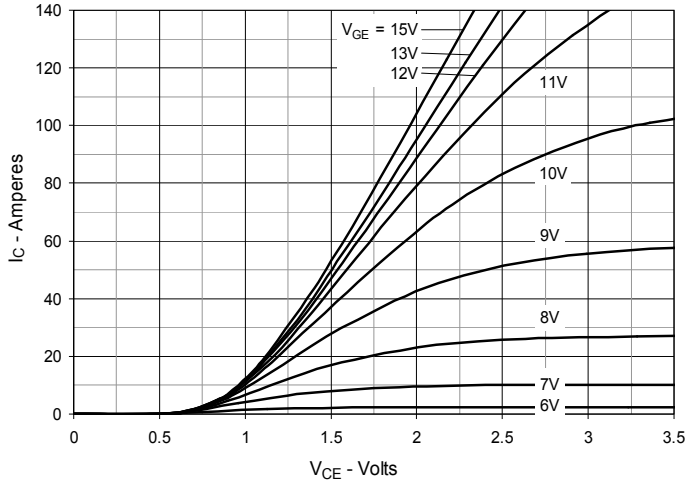
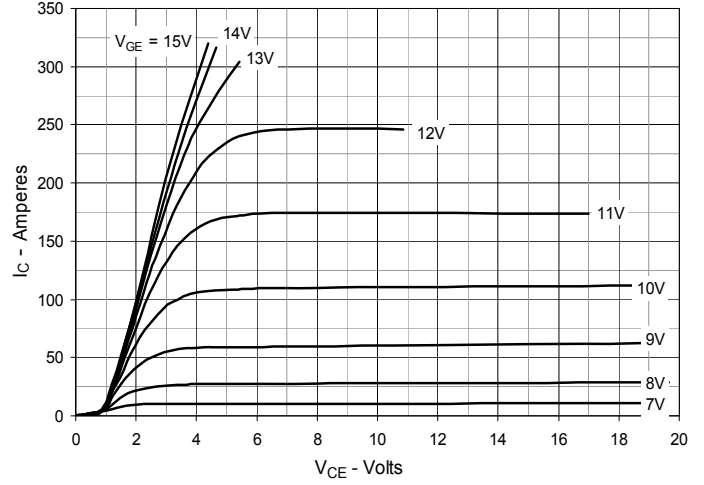
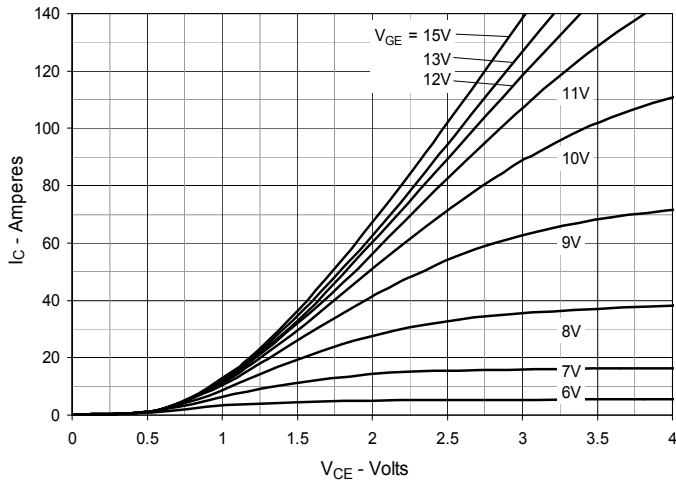
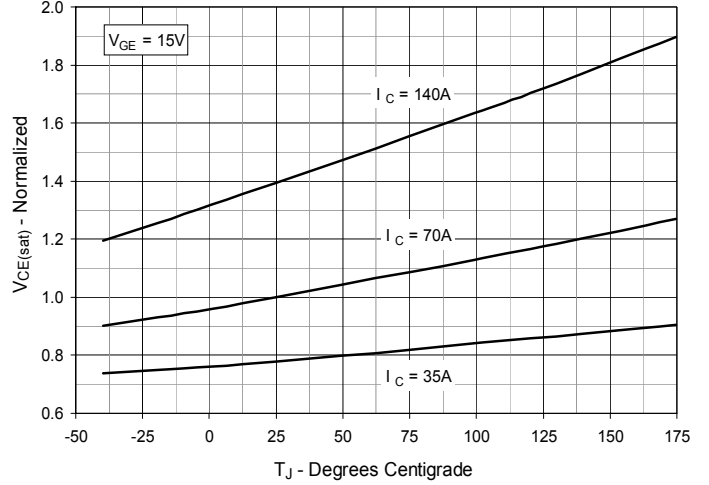
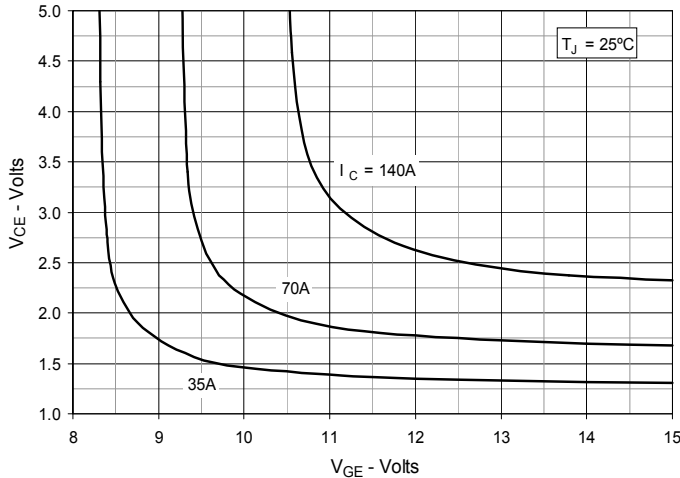
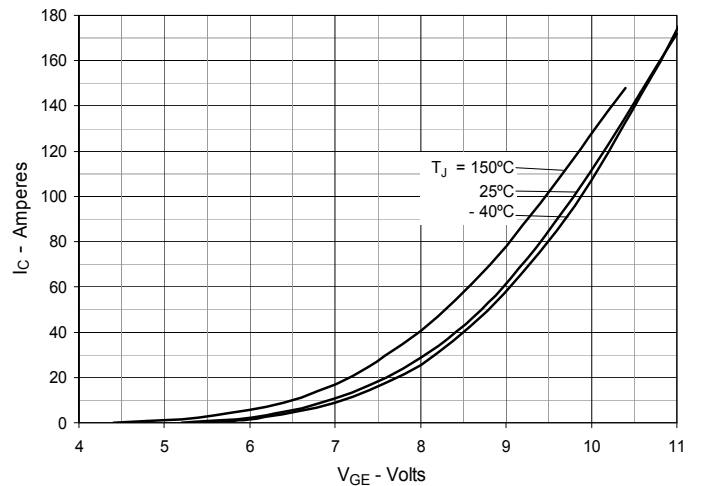
Fig. 6. Input Admittance

Fig. 7. Transconductance

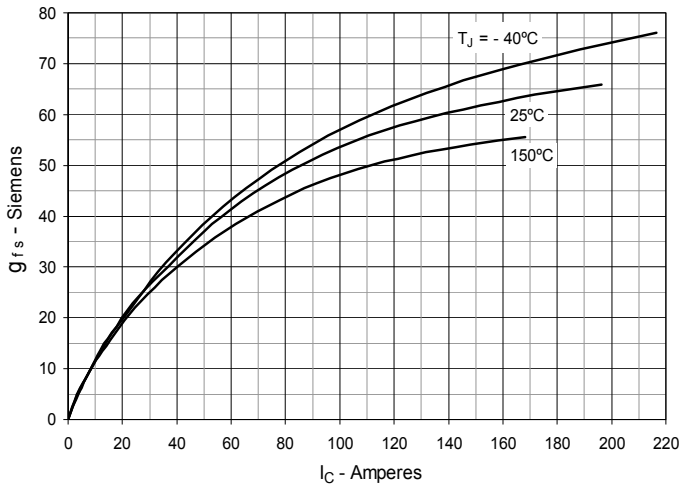

Fig. 8. Gate Charge

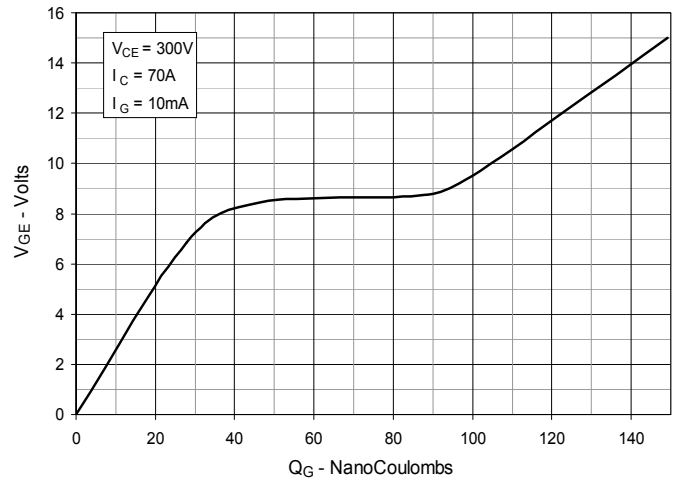

Fig. 9. Capacitance

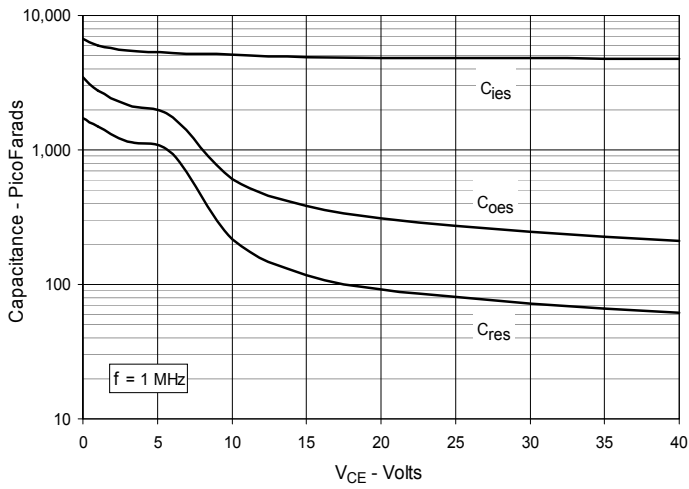

Fig. 10. Reverse-Bias Safe Operating Area

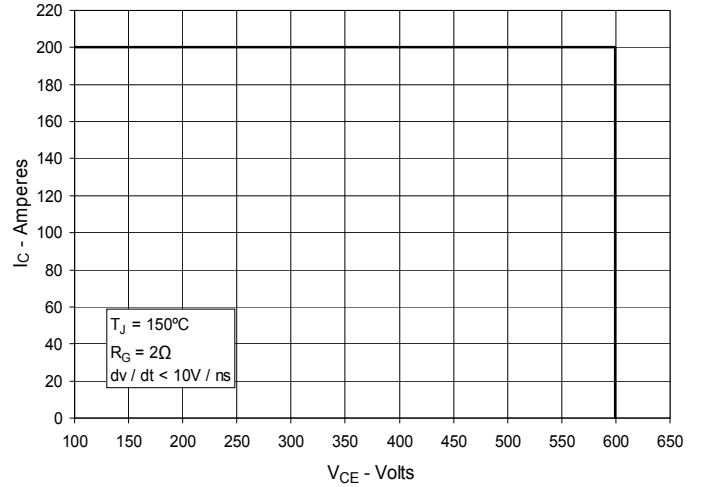

Fig. 11. Forward-Bias Safe Operating Area

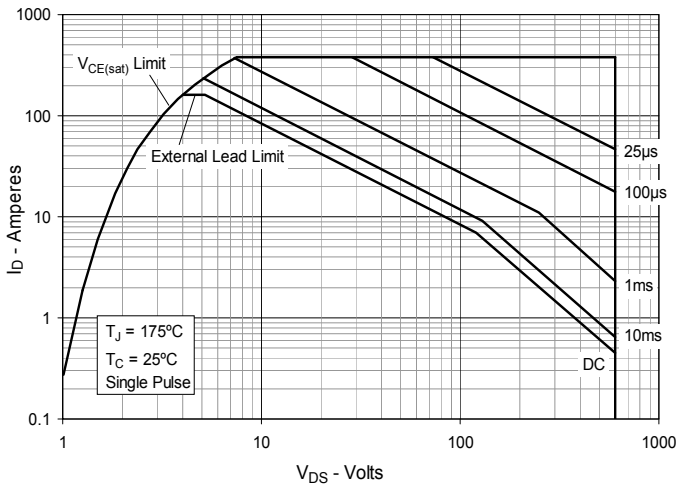

Fig. 12. Maximum Transient Thermal Impedance

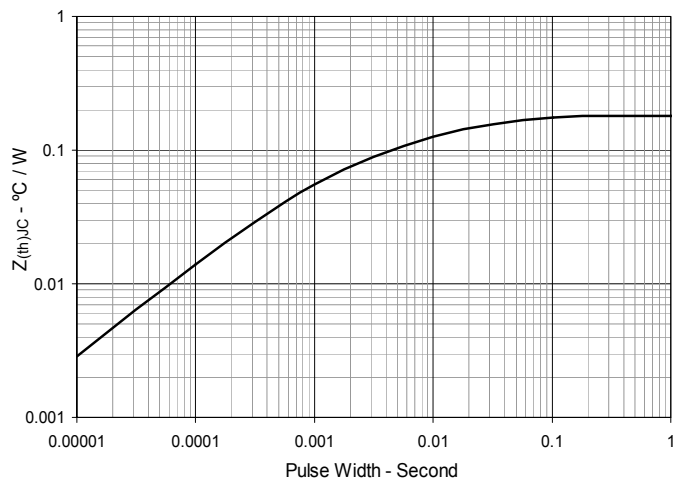

Fig. 13. Inductive Switching Energy Loss vs. Gate Resistance

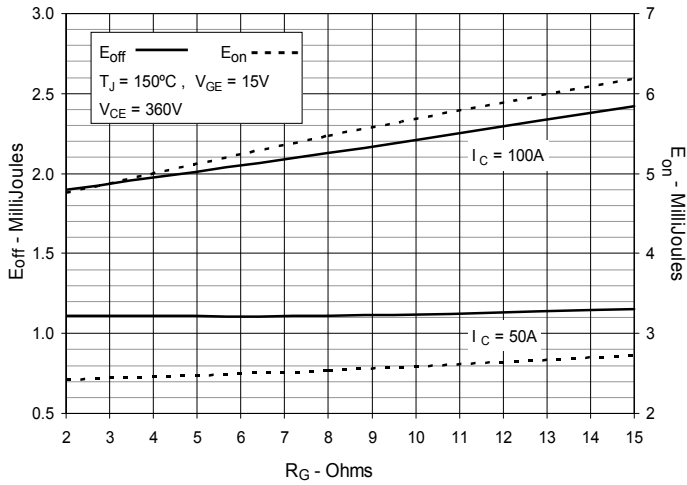

Fig. 14. Inductive Switching Energy Loss vs. Collector Current

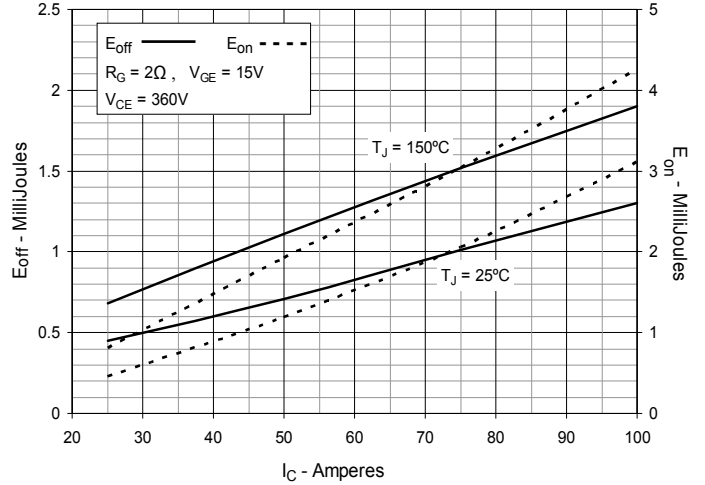

Fig. 15. Inductive Switching Energy Loss vs. Junction Temperature

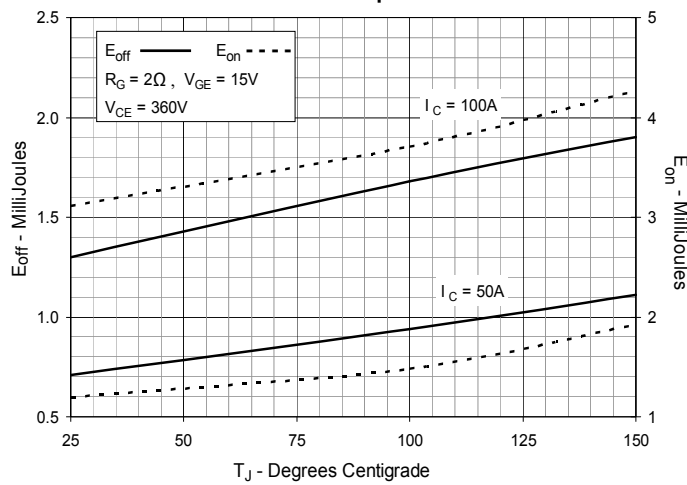

Fig. 16. Inductive Turn-off Switching Times vs. Gate Resistance

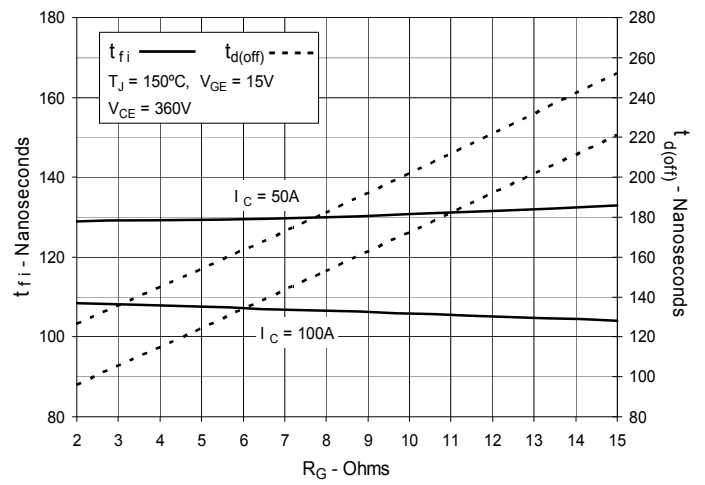

Fig. 17. Inductive Turn-off Switching Times vs. Collector Current

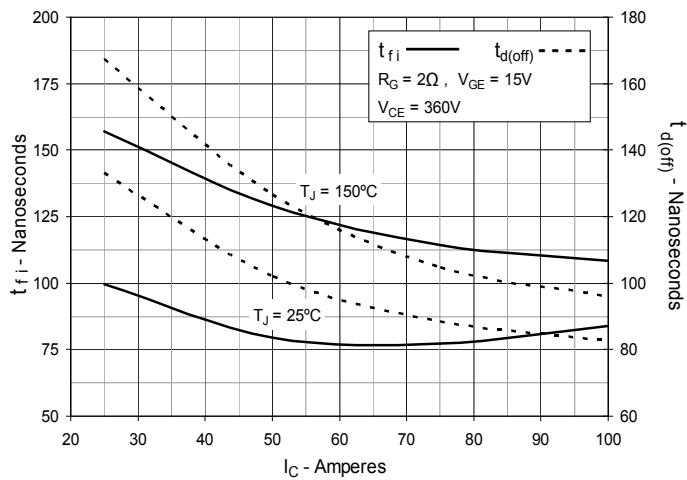

Fig. 18. Inductive Turn-off Switching Times vs. Junction Temperature

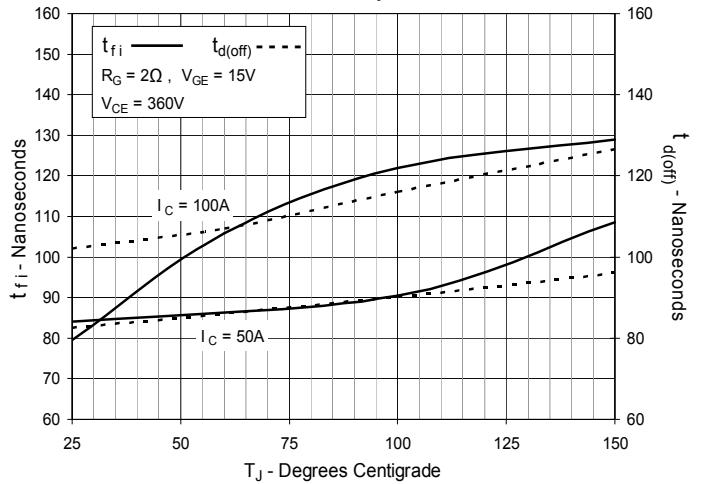
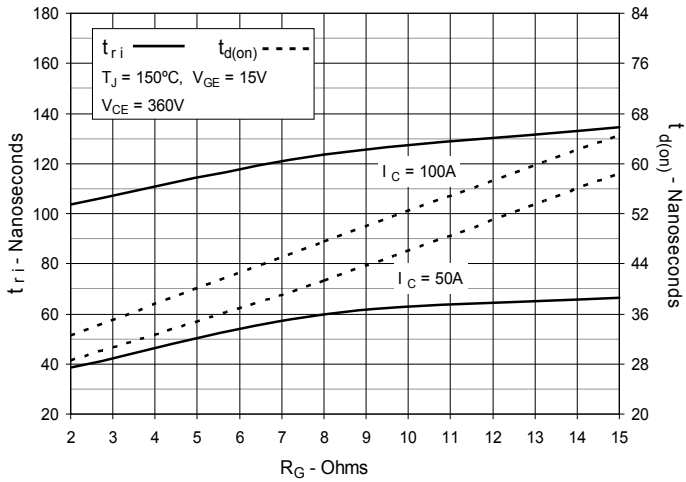
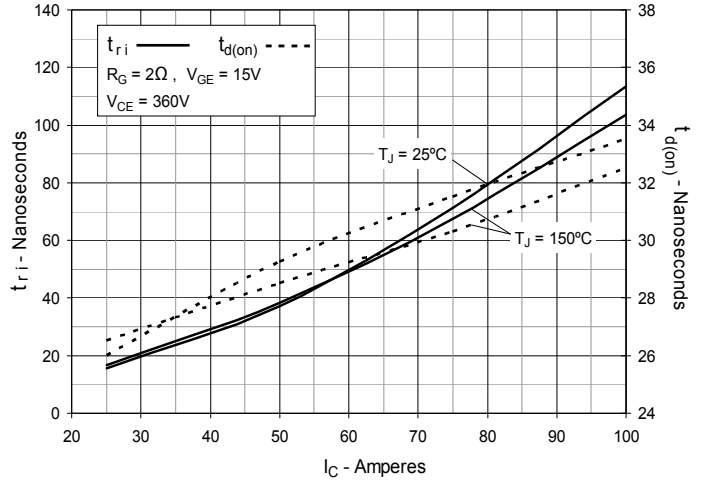
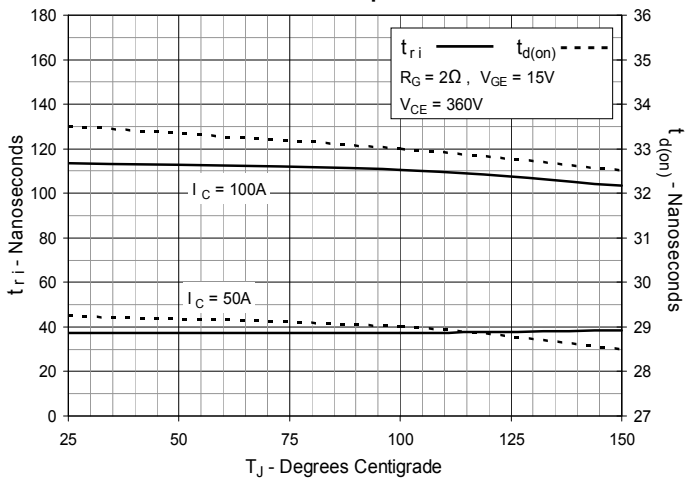

Fig. 19. Inductive Turn-on Switching Times vs. Gate Resistance

Fig. 20. Inductive Turn-on Switching Times vs. Collector Current

Fig. 21. Inductive Turn-on Switching Times vs. Junction Temperature



Disclaimer Notice - Information furnished is believed to be accurate and reliable. However, users should independently evaluate the suitability of and test each product selected for their own applications. Littelfuse products are not designed for, and may not be used in, all applications. Read complete Disclaimer Notice at www.littelfuse.com/disclaimer-electronics.