

(Standard)

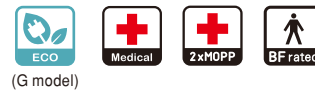

(Optional)



■ Features

- 5"×3" compact size
- Medical safety approved (2 x MOPP) according to ANSI/AAMI ES60601-1 and IEC/BS EN/EN 60601-1
- Suitable for BF application with appropriate system consideration
- 100W convection, 145W force air
- EMI Class B for Class I configuration
- No load power consumption < 0.75W by PS-ON control (G model)
- Extremely low leakage current
- 5Vdc standby output, Power Good, Power Fail
- Protections: Short circuit / Overload / Over voltage / Over temperature
- Lifetime > 85K hours
- 3 years warranty

■ Description

RPT(G)-160 is a 145W highly reliable PCB type medical power supply with a high power density on the 5" by 3" footprint. It accepts 90~264VAC input and offers triple output voltages. The extremely low leakage current is less than 160μA. In addition, it conforms to international medical regulations (2*MOPP) and EMC BS EN/EN55011, perfectly fitting all kinds of BF rated "patient contact" medical system equipment. RPT(G)-160 series also offers the enclosed style model [RPT(G)-160-C].

■ Model Encoding

RPT **G** - 160 **A** - **C**

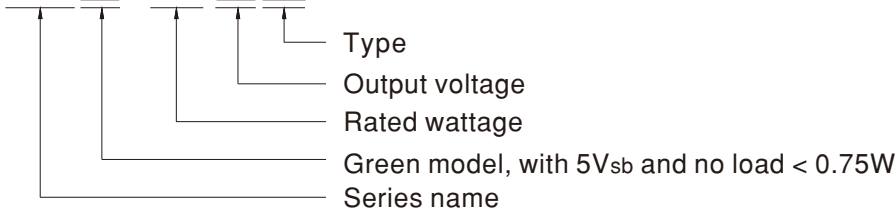

Type	Description	Note
Blank	PCB Type	In Stock
C	Enclosed casing type	Optional

■ Applications

- Oral irrigator
- Hemodialysis machine
- Medical monitors
- Sleep apnea devices
- Pumps machine

■ GTIN CODE

MW Search: <https://www.meanwell.com/serviceGTIN.aspx>

SPECIFICATION for PCB Type(standard)

MODEL		RPT(G)-160A			RPT(G)-160B			RPT(G)-160C			RPT(G)-160D			
OUTPUT	OUTPUT NUMBER	CH1	CH2	CH3	CH1	CH2	CH3	CH1	CH2	CH3	CH1	CH2	CH3	
	DC VOLTAGE	5V	12V	-5V	5V	12V	-12V	5V	15V	-15V	5V	12V	24V	
	CURRENT	RATED (20.5CFM)	14A	5.5A	1A	14A	5A	1A	14A	3.6A	1A	11A	5A	1.2A
		RANGE (20.5CFM)	0.6 ~ 14A	0.2 ~ 5.5A	0.1 ~ 1A	0.6 ~ 14A	0.2 ~ 5A	0.1 ~ 1A	0.6 ~ 14A	0.1 ~ 3.6A	0.1 ~ 1A	0.3 ~ 11A	0.2 ~ 5A	0.15 ~ 1.2A
		RANGE (convection)	0.6 ~ 9A	0.2 ~ 3.8A	0.1 ~ 0.6A	0.6 ~ 9A	0.2 ~ 3.4A	0.1 ~ 0.8A	0.6 ~ 9A	0.1 ~ 2.6A	0.1 ~ 0.8A	0.3 ~ 8A	0.2 ~ 2.6A	0.15 ~ 1A
	RATED POWER	20.5CFM Note.2	145W			146W			143W			147.8W		
		Convection Note.3	98.6W			98.4W			99W			98.2W		
	RIPPLE & NOISE (max.) Note.4	60mVp-p	80mVp-p	120mVp-p	60mVp-p	100mVp-p	100mVp-p	60mVp-p	80mVp-p	100mVp-p	80mVp-p	100mVp-p	120mVp-p	
	VOLTAGE ADJ. RANGE	CH1:5 ~ 5.5V												
	VOLTAGE TOLERANCE Note.5	±2.0%	±5.0%	-5,+7%	±2.0%	±5.0%	-4,+5%	±2.0%	±4.0%	±8.0%	±2.0%	±5.0%	+7,-5%	
	LINE REGULATION	±0.5%	±1.0%	±1.0%	±0.5%	±1.0%	±1.0%	±0.5%	±1.0%	±1.0%	±0.5%	±1.0%	±1.0%	
	LOAD REGULATION	±1.5%	±3.0%	-5,+6%	±1.5%	±3.0%	-4,+5%	±2.0%	±3.0%	±8.0%	±1.5%	±3.0%	-3,+4%	
SETUP, RISE TIME	1800ms, 30ms/230VAC 3500ms, 30ms/115VAC at full load													
HOLD UP TIME (Typ.)	30ms/230VAC 20ms/115VAC at full load													
INPUT	VOLTAGE RANGE Note.6	90 ~ 264VAC 127 ~ 370VDC												
	FREQUENCY RANGE	47 ~ 63Hz												
	POWER FACTOR (Typ.)	PF>0.93/230VAC PF>0.98/115VAC at full load												
	EFFICIENCY (Typ.)	84%			84%			83%			83%			
	AC CURRENT (Typ.)	1.8A/115VAC		0.9A/230VAC										
	INRUSH CURRENT (Typ.)	COLD START 35A/115VAC						70A/230VAC						
	LEAKAGE CURRENT (max.) Note.7	Earth leakage current < 160 μA/264VAC , Touch current < 100 μA/264VAC												
	PROTECTION	OVERLOAD	105 ~ 135% rated output power Protection type : Hiccup mode, recovers automatically after fault condition is removed											
OVER VOLTAGE		Ch1: 5.7 ~ 6.8V Protection type : Shut down o/p voltage, re-power on to recover												
OVER TEMPERATURE		TSW1: Shut down o/p voltage, recovers automatically after temperature goes down TSW2: Shut down o/p voltage, re-power on to recover												
FUNCTION	5V STANDBY (G model)	5Vsb : 5V@0.6A without fan, 0.8A with fan 20.5CFM ; Tolerance ± 2%, ripple : 50mVp-p(max.)												
	PS-ON INPUT SIGNAL (G model)	Power on: PS-ON = "Hi" or " > 2 ~ 5V" ; Power off: PS-ON = "Low" or " < 0 ~ 0.5V"												
	POWER GOOD / POWER FAIL	500ms>PG>10ms PF>1ms												
ENVIRONMENT	WORKING TEMP.	-20 ~ +70°C (Refer to "Derating Curve")												
	WORKING HUMIDITY	20 ~ 90% RH non-condensing												
	STORAGE TEMP., HUMIDITY	-40 ~ +85°C, 10 ~ 95% RH non-condensing												
	TEMP. COEFFICIENT	±0.03%/°C (0 ~ 50°C)												
	VIBRATION	10 ~ 500Hz, 2G 10min./1cycle, 60min. each along X, Y, Z axes												
	OPERATING ALTITUDE Note.8	3000 meters												
SAFETY & EMC (Note 10)	SAFETY STANDARDS	IEC60601-1, EAC TP TC 004,UL ANSI/AAMI ES60601-1, CAN/CSA-C22.2 No. 60601-1:14 - Edition 3 approved, TUV BS EN/EN60601-1 approved												
	ISOLATION LEVEL	Primary-Secondary: 2xMOPP, Primary-Earth:1xMOPP, Secondary-Earth:1xMOPP												
	WITHSTAND VOLTAGE	I/P-O/P:4KVAC I/P-FG:2KVAC O/P-FG:1.5KVAC												
	ISOLATION RESISTANCE	I/P-O/P, I/P-FG, O/P-FG:100M Ohms / 500VDC / 25°C / 70% RH												
	EMC EMISSION	Parameter		Standard					Test Level / Note					
		Conducted emission		BS EN/EN55011 (CISPR11)					Class B					
		Radiated emission		BS EN/EN55011 (CISPR11)					Class B					
		Harmonic current		BS EN/EN61000-3-2					Class A					
	Voltage flicker		BS EN/EN61000-3-3					-----						
	EMC IMMUNITY	BS EN/EN60601-1-2												
		Parameter		Standard					Test Level / Note					
		ESD		BS EN/EN61000-4-2					Level 4, 15KV air ; Level 4, 8KV contact					
RF field susceptibility		BS EN/EN61000-4-3					Level 3, 10V/m(80MHz~2.7GHz) Table 9, 9~28V/m(385MHz~5.78GHz)							
EFT bursts		BS EN/EN61000-4-4					Level 3, 2KV							
Surge susceptibility		BS EN/EN61000-4-5					Level 3, 2KV/Line-FG ; 1KV/Line-Line							
Conducted susceptibility		BS EN/EN61000-4-6					Level 3, 10V							
Magnetic field immunity		BS EN/EN61000-4-8					Level 4, 30A/m							
Voltage dip, interruption		BS EN/EN61000-4-11					100% dip 1 periods, 30% dip 25 periods, 100% interruptions 250 periods							
OTHERS	MTBF	1719.1K hrs min. Telcordia SR-332 (Bellcore) ; 175.1K hrs min. MIL-HDBK-217F (25°C)												
	DIMENSION (L*W*H)	PCB type: 127*76.2*34.6mm or 5*3*1.36" inch												
	PACKING	0.33Kg; 36pcs/12.9Kg/0.96CUFT												
NOTE	<p>1. All parameters NOT specially mentioned are measured at 230VAC input, rated load and 25°C of ambient temperature.</p> <p>2. The rated power includes 5Vsb @ 0.8A.</p> <p>3. The rated power includes 5Vsb @ 0.6A.</p> <p>4. Ripple & noise are measured at 20MHz of bandwidth by using a 12" twisted pair-wire terminated with a 0.1 μf & 47 μf parallel capacitor.</p> <p>5. Tolerance : includes set up tolerance, line regulation and load regulation.</p> <p>6. Derating may be needed under low input voltages. Please check the derating curve for more details.</p> <p>7. Touch current was measured from primary input to DC output.</p> <p>8. The ambient temperature derating of 3.5°C/1000m with fanless models and of 5°C/1000m with fan models for operating altitude higher than 2000m(6500ft).</p> <p>9. HS1,HS2 & HS3 can not be shorted.</p> <p>10. The power supply is considered a component which will be installed into a final equipment. All the EMC tests are been executed by mounting the unit on a 360mm*360mm metal plate with 1mm of thickness. The final equipment must be re-confirmed that it still meets EMC directives. For guidance on how to perform these EMC tests, please refer to "EMI testing of component power supplies." (as available on http://www.meanwell.com)</p> <p>※ Product Liability Disclaimer : For detailed information, please refer to https://www.meanwell.com/serviceDisclaimer.aspx</p>													

SPECIFICATION for Enclosed Type(optional)

MODEL		RPT(G)-160A-C			RPT(G)-160B-C			RPT(G)-160C-C			RPT(G)-160D-C			
OUTPUT	OUTPUT NUMBER	CH1	CH2	CH3	CH1	CH2	CH3	CH1	CH2	CH3	CH1	CH2	CH3	
		DC VOLTAGE	5V	12V	-5V	5V	12V	-12V	5V	15V	-15V	5V	12V	24V
	CURRENT	RATED (20.5CFM)	13.3A	5.2A	0.95A	13.3A	4.8A	0.95A	13.3A	3.4A	0.95A	10.5A	4.8A	1.14A
		RANGE (20.5CFM)	0.6 ~ 13.3A	0.2 ~ 5.2A	0.1 ~ 0.95A	0.6 ~ 13.3A	0.2 ~ 4.8A	0.1 ~ 0.95A	0.6 ~ 13.3A	0.1 ~ 3.4A	0.1 ~ 0.95A	0.3 ~ 10.5A	0.2 ~ 4.8A	0.15 ~ 1.14A
		RANGE (convection)	0.6 ~ 8.5A	0.2 ~ 3.6A	0.1 ~ 0.57A	0.6 ~ 8.5A	0.2 ~ 3.2A	0.1 ~ 0.76A	0.6 ~ 8.5A	0.1 ~ 2.5A	0.1 ~ 0.76A	0.3 ~ 7.6A	0.2 ~ 2.5A	0.15 ~ 0.95A
	RATED POWER	20.5CFM Note.2	137.7W			139.5W			135.8W			141.5W		
		Convection Note.3	91.6W			93W			94.4W			93.8W		
		RIPPLE & NOISE (max.) Note.4	60mVp-p	80mVp-p	120mVp-p	60mVp-p	100mVp-p	100mVp-p	60mVp-p	80mVp-p	100mVp-p	80mVp-p	100mVp-p	120mVp-p
		VOLTAGE ADJ. RANGE	CH1:5 ~ 5.5V											
		VOLTAGE TOLERANCE Note.5	±2.0%	±5.0%	-5,+7%	±2.0%	±5.0%	-4,+5%	±2.0%	±4.0%	±8.0%	±2.0%	±5.0%	+7,-5%
	LINE REGULATION	±0.5%	±1.0%	±1.0%	±0.5%	±1.0%	±1.0%	±0.5%	±1.0%	±1.0%	±0.5%	±1.0%	±1.0%	
	LOAD REGULATION	±1.5%	±3.0%	-5,+6%	±1.5%	±3.0%	-4,+5%	±2.0%	±3.0%	±8.0%	±1.5%	±3.0%	-3,+4%	
	SETUP, RISE TIME	1800ms, 30ms/230VAC			3500ms, 30ms/115VAC at full load									
	HOLD UP TIME (Typ.)	30ms/230VAC			20ms/115VAC at full load									
INPUT	VOLTAGE RANGE Note.6	90 ~ 264VAC			127 ~ 370VDC									
	FREQUENCY RANGE	47 ~ 63Hz												
	POWER FACTOR (Typ.)	PF>0.93/230VAC			PF>0.98/115VAC at full load									
	EFFICIENCY (Typ.)	84%			84%			83%			83%			
	AC CURRENT (Typ.)	1.8A/115VAC			0.9A/230VAC									
	INRUSH CURRENT (Typ.)	COLD START 35A/115VAC			70A/230VAC									
	LEAKAGE CURRENT (max.) Note.7	Earth leakage current < 160 μA/264VAC , Touch current < 100 μA/264VAC												
PROTECTION	OVERLOAD	105 ~ 135% rated output power Protection type : Hiccup mode, recovers automatically after fault condition is removed												
	OVER VOLTAGE	Ch1: 5.7 ~ 6.8V Protection type : Shut down o/p voltage, re-power on to recover												
	OVER TEMPERATURE	TSW1: Shut down o/p voltage, recovers automatically after temperature goes down TSW2: Shut down o/p voltage, re-power on to recover												
FUNCTION	5V STANDBY (G model)	5Vsb : 5V@0.6A without fan, 0.8A with fan 20.5CFM ; Tolerance ± 2%, ripple : 50mVp-p(max.)												
	PS-ON INPUT SIGNAL (G model)	Power on: PS-ON = "Hi" or " > 2 ~ 5V" ; Power off: PS-ON = "Low" or " < 0 ~ 0.5V"												
	POWER GOOD / POWER FAIL	500ms>PG>10ms			PF>1ms									
ENVIRONMENT	WORKING TEMP.	-20 ~ +70°C (Refer to "Derating Curve")												
	WORKING HUMIDITY	20 ~ 90% RH non-condensing												
	STORAGE TEMP., HUMIDITY	-40 ~ +85°C , 10 ~ 95% RH non-condensing												
	TEMP. COEFFICIENT	±0.03%/°C (0 ~ 50°C)												
	VIBRATION	10 ~ 500Hz, 2G 10min./1cycle, 60min. each along X, Y, Z axes												
	OPERATING ALTITUDE Note.8	3000 meters												
SAFETY & EMC (Note 10)	SAFETY STANDARDS	Design refer to IEC60601-1, EAC TP TC 004, TUV BS EN/EN60601-1(Pending for CB/TUV)												
	ISOLATION LEVEL	Primary-Secondary: 2xMOPP, Primary-Earth: 1xMOPP, Secondary-Earth: 1xMOPP												
	WITHSTAND VOLTAGE	I/P-O/P:4KVAC			I/P-FG:2KVAC			O/P-FG:1.5KVAC						
	ISOLATION RESISTANCE	I/P-O/P, I/P-FG, O/P-FG:100M Ohms / 500VDC / 25°C / 70% RH												
	EMC EMISSION	Parameter		Standard					Test Level / Note					
		Conducted emission		BS EN/EN55011 (CISPR11)					Class B					
		Radiated emission		BS EN/EN55011 (CISPR11)					Class B					
		Harmonic current		BS EN/EN61000-3-2					Class A					
	Voltage flicker		BS EN/EN61000-3-3					-----						
	EMC IMMUNITY	BS EN/EN60601-1-2												
		Parameter		Standard					Test Level / Note					
		ESD		BS EN/EN61000-4-2					Level 4, 15KV air ; Level 4, 8KV contact					
		RF field susceptibility		BS EN/EN61000-4-3					Level 3, 10V/m(80MHz~2.7GHz) Table 9, 9~28V/m(385MHz~5.78GHz)					
		EFT bursts		BS EN/EN61000-4-4					Level 3, 2KV					
Surge susceptibility		BS EN/EN61000-4-5					Level 3, 2KV/Line-FG ; 1KV/Line-Line							
Conducted susceptibility		BS EN/EN61000-4-6					Level 3, 10V							
Magnetic field immunity		BS EN/EN61000-4-8					Level 4, 30A/m							
Voltage dip, interruption		BS EN/EN61000-4-11					100% dip 1 periods, 30% dip 25 periods, 100% interruptions 250 periods							
OTHERS	MTBF	1719.1K hrs min. Telcordia SR-332 (Bellcore) ; 175.1K hrs min. MIL-HDBK-217F (25°C)												
	DIMENSION	Enclosed type: 130*86*43mm or 5.11"*3.39"*1.69" inch												
	PACKING	0.49Kg; 24pcs/12.8Kg/0.77CUFT												
NOTE	<p>1. All parameters NOT specially mentioned are measured at 230VAC input, rated load and 25°C of ambient temperature.</p> <p>2. The rated power includes 5Vsb @ 0.8A.</p> <p>3. The rated power includes 5Vsb @ 0.6A.</p> <p>4. Ripple & noise are measured at 20MHz of bandwidth by using a 12" twisted pair-wire terminated with a 0.1μf & 47μf parallel capacitor.</p> <p>5. Tolerance : includes set up tolerance, line regulation and load regulation.</p> <p>6. Derating may be needed under low input voltages. Please check the derating curve for more details.</p> <p>7. Touch current was measured from primary input to DC output.</p> <p>8. The ambient temperature derating of 3.5°C/1000m with fanless models and of 5°C/1000m with fan models for operating altitude higher than 2000m(6500ft).</p> <p>9. HS1,HS2 & HS3 can not be shorted.</p> <p>10. The power supply is considered a component which will be installed into a final equipment. All the EMC tests are been executed by mounting the unit on a 360mm*360mm metal plate with 1mm of thickness. The final equipment must be re-confirmed that it still meets EMC directives. For guidance on how to perform these EMC tests, please refer to "EMI testing of component power supplies." (as available on http://www.meanwell.com)</p> <p>※ Product Liability Disclaimer : For detailed information, please refer to https://www.meanwell.com/serviceDisclaimer.aspx</p>													

■ Block Diagram

fosc :100KHz

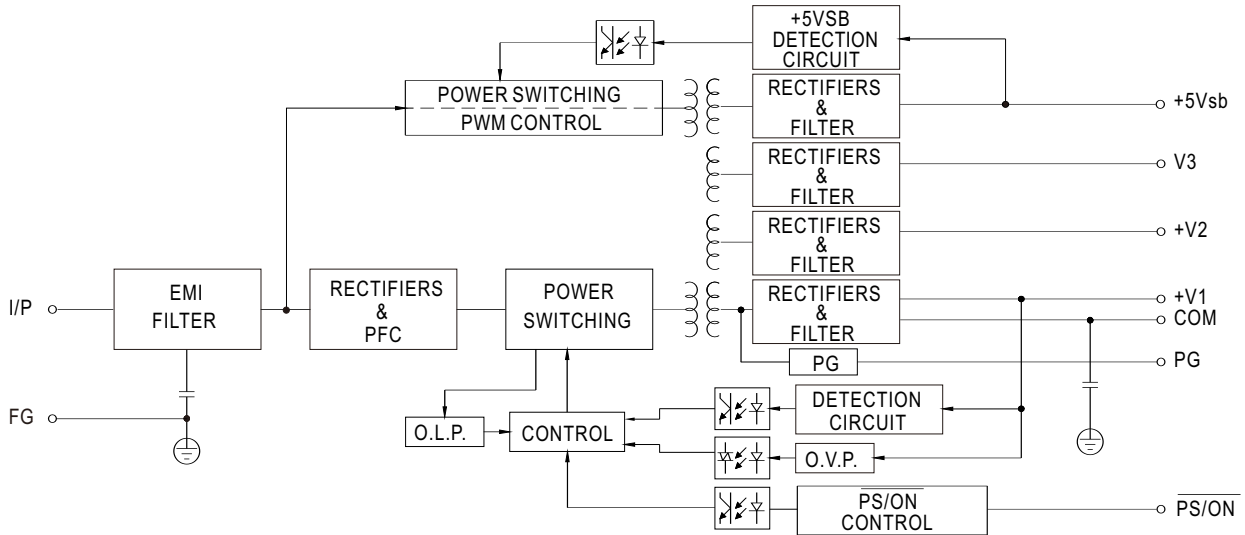

■ Derating Curve

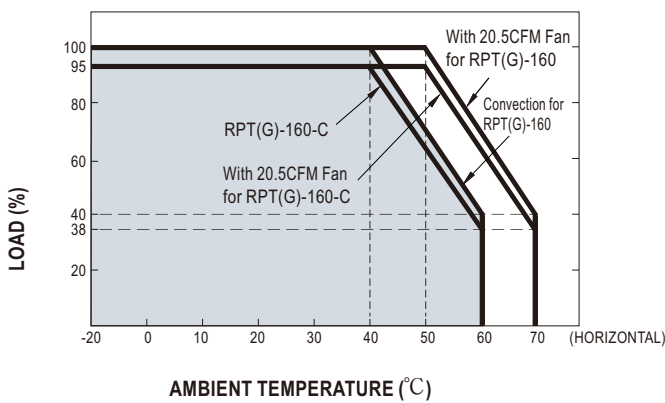

■ Output Derating VS Input Voltage

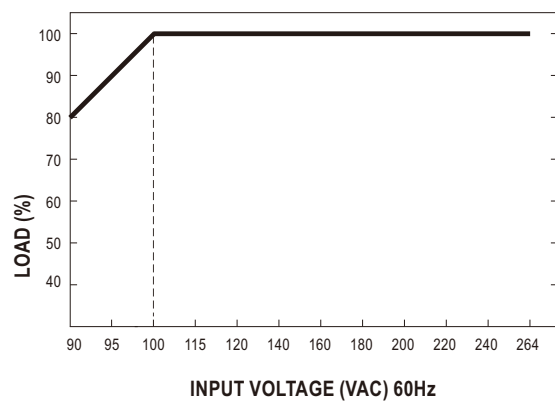

■ Mechanical Specification

Unit:mm

● PCB Type: RPT-160(G)

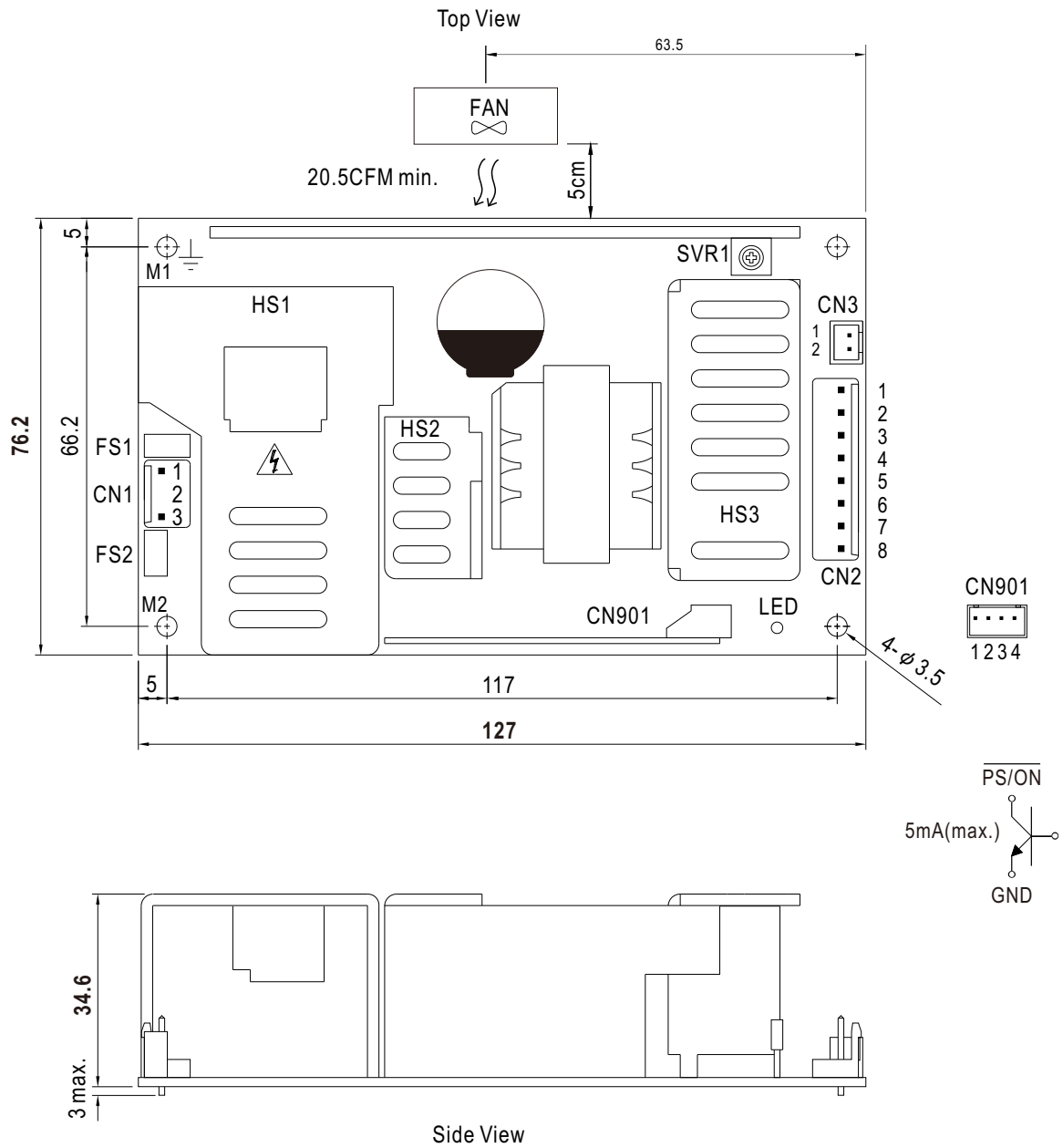

● Enclosed Type: RPT-160(G)-C

Case No.247A Unit:mm

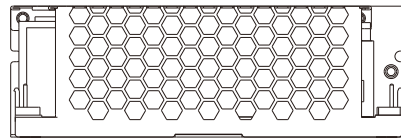

Side View

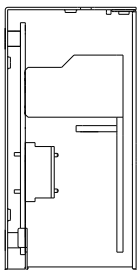
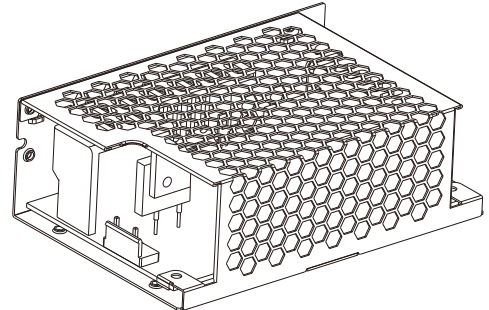

Side View

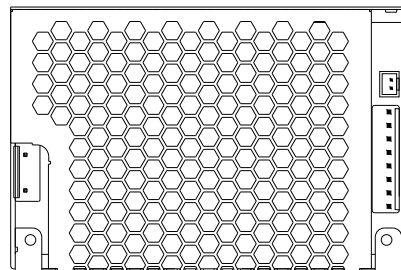

Top View

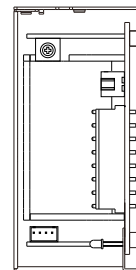
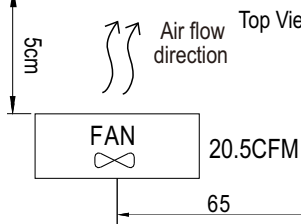

Side View

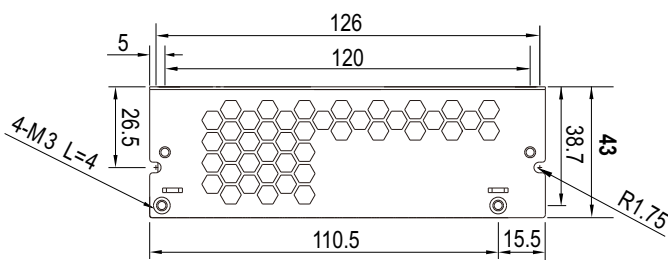

Side View

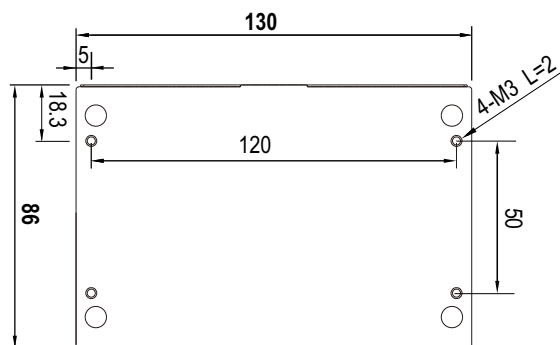

Bottom View

※ Mounting Instruction

Hole No.	Recommended Screw Size	MAX. Penetration Depth L	Recommended mounting torque
① ②	M3	2mm	4~6Kgf-cm

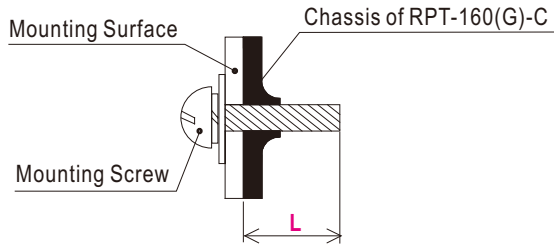

AC Input Connector (CN1) : JST B3P-VH or equivalent

Pin No.	Assignment	Mating Housing	Terminal
1	AC/L	JST VHR or equivalent	JST SVH-21T-P1.1 or equivalent
2	No Pin		
3	AC/N		

DC Output Connector (CN2) : JST B8P-VH or equivalent

Pin No.	Assignment	Mating Housing	Terminal
1,2,3,4	COM	JST VHR or equivalent	JST SVH-21T-P1.1 or equivalent
5,6	CH1		
7	CH2		
8	CH3		

Power Good Connector(CN3):JST B2B-XH or equivalent

Pin No.	Status	Mating Housing	Terminal
1	PG	JST XHP or equivalent	JST SXH-001T-P0.6 or equivalent
2	GND		

5VSB Connector(CN901) : JST B-XH or equivalent

Pin No.	Assignment	Mating Housing	Terminal
1	PS/ON	JST XHP or equivalent	JST SXH-001T or equivalent
2,4	GND		
3	5VSB		

- ⚠ 1.HS1,HS2,HS3 can not be shorted
2.M1 and M2 are Safety ground and should all be grounded.

- ※ Note: 1. The PCB type (Blank Type) model delivers EMI Class B for both conducted emission and radiated emission for the power supply, when configured into either Class I (with FG).
2. The enclosed type (-C type) model is not suitable for configuration within a Class II (no FG) system, but suggested within a Class I (with FG) system.
3. Mounting Instruction for Enclosed type only.

■ INSTALLATION MANUAL

Please refer to : <http://www.meanwell.com/manual.html>