

■ Features

- 3"×2" compact size
- 120W convention, 150W peak (10sec.)
- Medical safety approved (2 x MOPP) according to ANSI/AAMI ES60601-1 and IEC/BS EN/EN60601-1
- Suitable for BF application with appropriate system consideration
- EMI for both Class I & Class II configuration
- -30~+85°C wide range operating temperature
- No load power consumption<0.3W
- Extremely low leakage current
- Protections: Short circuit / Overload / Over voltage / Over temperature
- Operating altitude up to 4000 meters (Note.6)
- 3 years warranty

■ Applications

- Oral irrigator
- Hemodialysis machine
- Medical monitors
- Sleep apnea devices
- Pumps machine

■ GTIN CODE

MW Search: <https://www.meanwell.com/serviceGTIN.aspx>

■ Description

RPS-120S is a 120W highly reliable green PCB type medical power supply with a high power density on a 3" by 2" footprint. It accepts 80~264VAC input and offers various models with the output voltages between 12V and 48V. The working efficiency is up to 94% and the extremely low no load power consumption is down below 0.3W. RPS-120S is able to be used for both Class I (with FG) & Class II (no FG) system design. The extremely low leakage current is less than 150μA. In addition, it conforms to the international medical regulations (2*MOPP) and EMC BS EN/EN55011, perfectly fitting all kinds of BF rated "patient contact" medical system equipment.

■ Model Encoding

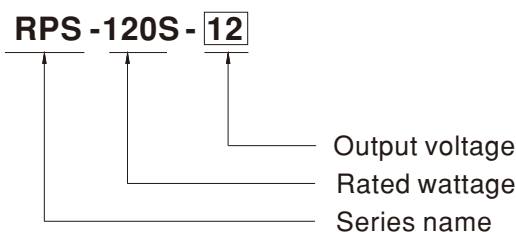

SPECIFICATION

MODEL		RPS-120S-12	RPS-120S-15	RPS-120S-24	RPS-120S-27	RPS-120S-48	
OUTPUT	DC VOLTAGE	12V	15V	24V	27V	48V	
	CURRENT	Peak(10 sec.)	11.8A	9.5A	6.25A	5.55A	3.125A
		Convection	9.5A	7.6A	5A	4.44A	2.5A
	RATED POWER	Peak(10 sec.)	141.6W	142.5W	150W	149.8W	150W
		Convection	114W	114W	120W	119.9W	120W
	RIPPLE & NOISE (max.) Note.2	100mVp-p	120mVp-p	150mVp-p	150mVp-p	200mVp-p	
	VOLTAGE ADJ. RANGE	11.4~12.6V	14.3~15.8V	22.8~25.2V	25.6 ~ 28.4V	45.6 ~50.4V	
	VOLTAGE TOLERANCE Note.3	±2.0%	±2.0%	±1.0%	±1.0%	±1.0%	
	LINE REGULATION	±0.5%	±0.5%	±0.5%	±0.5%	±0.5%	
	LOAD REGULATION	±1.0%	±1.0%	±1.0%	±1.0%	±1.0%	
SETUP, RISE TIME	600ms, 30ms/230VAC 600ms, 30ms/115VAC at full load						
HOLD UP TIME (Typ.)	15ms/230VAC	15ms/115VAC at full load					
INPUT	VOLTAGE RANGE Note.4	80 ~ 264VAC	113 ~ 370VDC				
	FREQUENCY RANGE	47 ~ 63Hz					
	POWER FACTOR	PF>0.94/230VAC		PF>0.98/115VAC at full load			
	EFFICIENCY (Typ.)	91%	92%	93%	94%	93.5%	
	AC CURRENT (Typ.)	2.3A/115VAC	1.1A/230VAC				
	INRUSH CURRENT (Typ.)	COLD START 30A/115VAC		60A/230VAC			
	LEAKAGE CURRENT(max.) Note.5	Earth leakage current < 150µA/264VAC , touch current < 80µA/264VAC					
PROTECTION	OVERLOAD	130~160% rated output power Protection type : Hiccup mode, recovers automatically after fault condition is removed					
	OVER VOLTAGE	13.2 ~ 15.6V	16.5 ~ 19.5V	26.4 ~ 31.2V	29.7 ~ 35V	52.8 ~ 62.4V	
	OVER TEMPERATURE	Protection type : Shut down o/p voltage, recovers automatically after temperature goes down					
ENVIRONMENT	WORKING TEMP.	-30 ~ +85°C (Refer to "Derating Curve")					
	WORKING HUMIDITY	20 ~ 90% RH non-condensing					
	STORAGE TEMP.	-40 ~ +85°C					
	TEMP. COEFFICIENT	±0.03%/°C (0 ~ 50°C)					
	VIBRATION	10 ~ 500Hz, 2G 10min./1cycle, 60min. each along X, Y, Z axes					
	OPERATING ALTITUDE Note.6	4000 meters					
SAFETY & EMC (Note 7)	SAFETY STANDARDS	IEC60601-1, TUV BS EN/EN60601-1, EAC TP TC 004, UL ANSI / AAMI ES60601-1 (3.1 version), CAN/CSA-C22.2 No. 60601-1:14 - Edition 3 approved; Design refer to BS EN/EN60335-1 (By request)					
	ISOLATION RESISTANCE	Primary-Secondary: 2xMOPP, Primary-Earth:1xMOPP, Secondary-Earth:1xMOPP					
	WITHSTAND VOLTAGE	I/P-O/P:4KVAC I/P-FG:2KVAC O/P-FG:1.5KVAC					
	ISOLATION RESISTANCE	I/P-O/P, I/P-FG, O/P-FG: 100M Ohms / 500VDC / 25°C / 70% RH					
	EMC EMISSION	Parameter	Standard			Test Level / Note	
		Conducted emission	BS EN/EN55011 (CISPR11)			Class B	
		Radiated emission	BS EN/EN55011 (CISPR11)			Class I : Class B , Class II : Class A	
		Harmonic current	BS EN/EN61000-3-2			Class A	
	Voltage flicker	BS EN/EN61000-3-3			-----		
	EMC IMMUNITY	BS EN/EN60601-1-2					
		Parameter	Standard			Test Level / Note	
		ESD	BS EN/EN61000-4-2			Level 4, 15KV air ; Level 4, 8KV contact	
		RF field susceptibility	BS EN/EN61000-4-3			Level 3, 10V/m(80MHz~2.7GHz) Table 9, 9~28V/m(385MHz~5.78GHz)	
		EFT bursts	BS EN/EN61000-4-4			Level 3, 2KV	
Surge susceptibility		BS EN/EN61000-4-5			Level 4, 4KV/Line-FG; 2KV/Line-Line		
Conducted susceptibility		BS EN/EN61000-4-6			Level 3, 10V		
Magnetic field immunity		BS EN/EN61000-4-8			Level 4, 30A/m		
Voltage dip, interruption	BS EN/EN61000-4-11			95% dip 1 periods, 30% dip 25 periods, 95% interruptions 250 periods			
OTHERS	MTBF	4050.3K hrs min. Telcordia SR-332 (Bellcore) ; 468.0K hrs min. MIL-HDBK-217F (25°C)					
	DIMENSION (L*W*H)	76.2*50.8*28mm or 3" * 2" *1.1" inch					
	PACKING	0.13Kg; 100pcs/14Kg/1.13CUFT					
NOTE	<p>1. All parameters NOT specially mentioned are measured at 230VAC input, rated load and 25 of ambient temperature.</p> <p>2. Ripple & noise are measured at 20MHz of bandwidth by using a 12" twisted pair-wire terminated with a 0.1µf & 47µf parallel capacitor.</p> <p>3. Tolerance : includes set up tolerance, line regulation and load regulation.</p> <p>4. Derating may be needed under low input voltages. Please check the derating curve for more details.</p> <p>5. Touch current was measured from primary input to DC output.</p> <p>6. The ambient temperature derating of 3.5°C/1000m with fanless models and of 5°C/1000m with fan models for operating altitude higher than 2000m(6500ft).</p> <p>7. The power supply is considered a component which will be installed into a final equipment. All the EMC tests are been executed by mounting the unit on a 360mm*360mm metal plate with 1mm of thickness. The final equipment must be re-confirmed that it still meets EMC directives. For guidance on how to perform these EMC tests, please refer to "EMI testing of component power supplies." (as available on http://www.meanwell.com)</p> <p>※ Product Liability Disclaimer : For detailed information, please refer to https://www.meanwell.com/serviceDisclaimer.aspx</p>						

Block Diagram

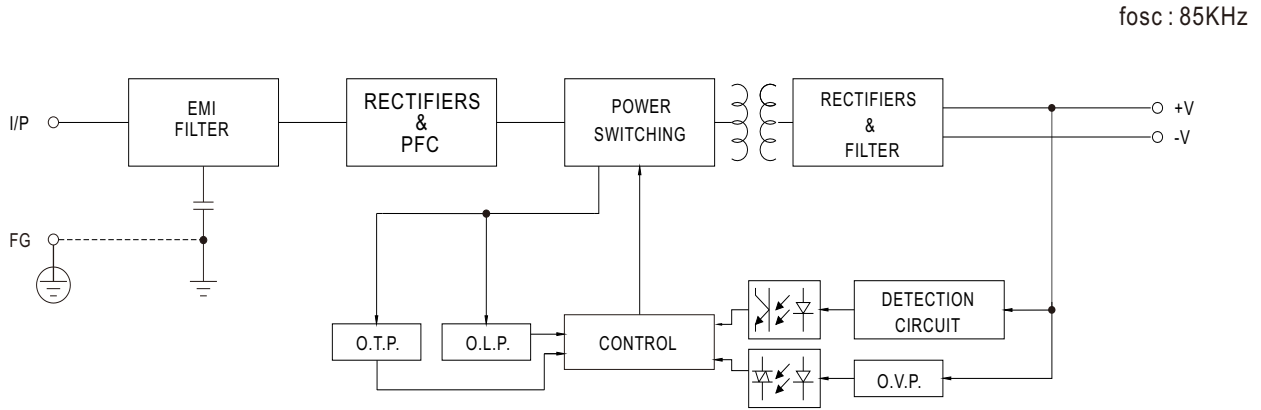

Derating Curve

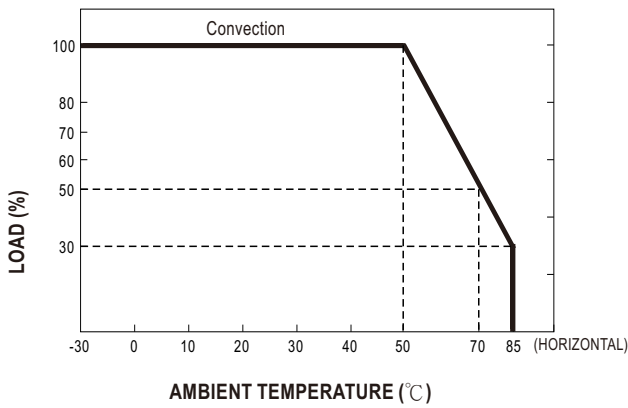

Output Derating VS Input Voltage

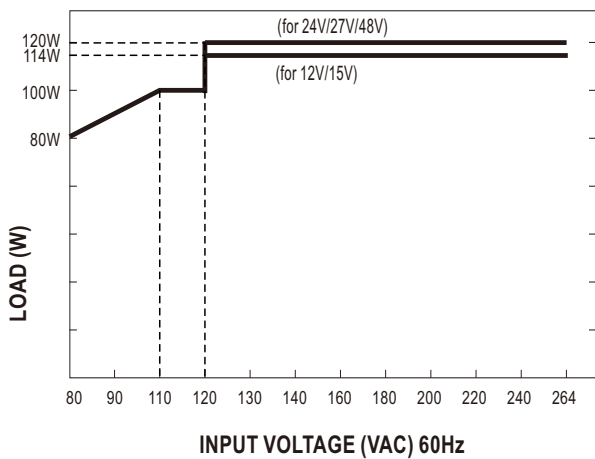

■ Mechanical Specification

Unit:mm

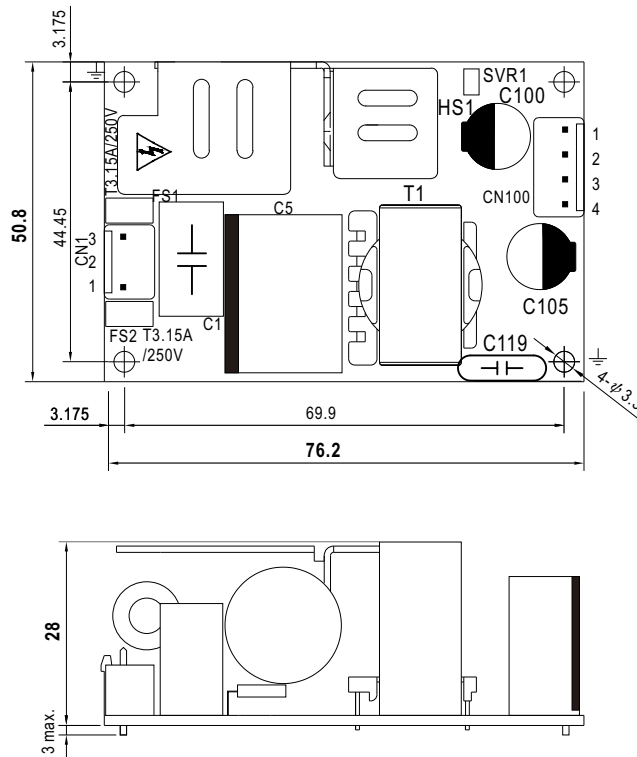

AC Input Connector (CN1) : JST B3P-VH or equivalent

Pin No.	Assignment	Mating Housing	Terminal
1	AC/L	JST VHR or equivalent	JST SVH-21T-P1.1 or equivalent
2	No Pin		
3	AC/N		

DC Output Connector (CN2) : JST B4P-VH or equivalent

Pin No.	Assignment	Mating Housing	Terminal
1,2	+V	JST VHR or equivalent	JST SVH-21T-P1.1 or equivalent
3,4	-V		

⚠ 1.HS1 must have safety isolation distance with system case.

※Note :

- 1.RPS-120S model delivers EMI Class B for both conducted emission and radiated emission for the power supply, when configured into Class I (with FG) system.
- 2.RPS-120S model delivers EMI Class B conducted emission and Class A radiated emission with King Core K5B RC (12*15*7) in output cable for the power supply when configured into Class II (no FG) system.

■ Installation Manual

Please refer to : <http://www.meanwell.com/manual.html>