



Features

- Universal AC input / Full range
- Fanless design, 400W convection
- Modular design, optional configuration available
- Slim and 1U low profile
- No minimum load required
- Protections: Short circuit / Overload / Over voltage / Over temperature
- -30 ~ +70°C working temperature
- LED indicator for power on
- 3 years warranty

Applications

- Diagnostic or biological facilities
- Test or measurement systems
- Telecommunication equipment
- Industrial automation machinery
- Industrial control system
- Mechanical and electrical equipment

GTIN CODE

MW Search: <https://www.meanwell.com/serviceGTIN.aspx>

Description

The UMP-400 series is the break-through 1U height modular power supply from MEAN WELL, and it can deliver up to 400W maximum output power with convection cooling only. The front-end can function as an independent 400W 24V or 48V single output power supply, and it can be configured into a multi-channel modular power supply by incorporating the NID series non-isolated DC-DC converters, which are also standalone standard products that can be purchased and used separately. The NID output modules can deliver up to 100W with adjustable options for the major working voltages used in the industry, including 5V, 12V, 15V and 24V. In addition, the UMP-400 series is certified to ITE 62368-1 safety standards, and is designed to meet medical (2xMOPP) safety standard, thus offering the best flexibility for various types of applications.

Output Configuration Guide (Please contact MEAN WELL sales or distributors for multi-channel configurations)

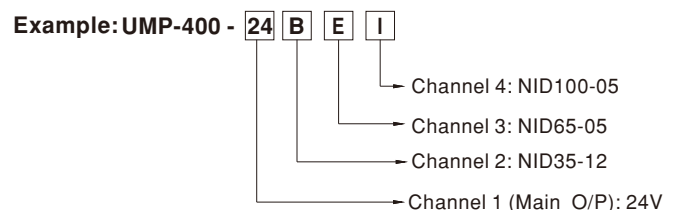
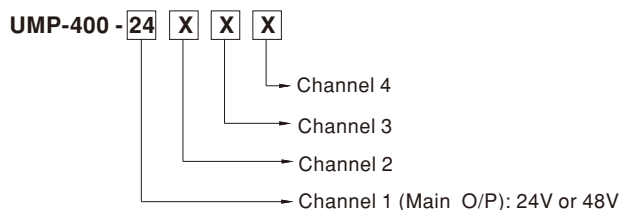

X:

DC-DC O/P Module	O/P Voltage	O/P Current
A	NID35-05	5V 3.5A
B	NID35-12	12V 2.9A
C	NID35-15	15V 2.4A
D	NID35-24	24V 1.5A
E	NID65-05	5V 6.5A
F	NID65-12	12V 4.9A
G	NID65-15	15V 4.3A
H	NID65-24	24V 2.7A
I	NID100-05	5V 8.0A
J	NID100-12	12V 6.0A
K	NID100-15	15V 5.2A
L	NID100-24	24V 3.4A

DC-DC O/P Module	O/P Voltage	O/P Current
M	NID35-05	-5V -3.5A
N	NID35-12	-12V -2.9A
O	NID35-15	-15V -2.4A
P	NID65-05	-5V -6.5A
Q	NID65-12	-12V -4.9A
R	NID65-15	-15V -4.3A
S	NID100-05	-5V -8.0A
T	NID100-12	-12V -6.0A
U	NID100-15	-15V -5.2A

Note:

- 1: NID35/65/100-24 modules are intended for UMP-400-48 only.
- 2: Only UMP-400-24 can be configured with negative output voltage modules.
- 3: Only output channel 4(V4) may be configured as negative voltage.

SPECIFICATION

MODEL		UMP-400-24	UMP-400-48	
SINGLE OUTPUT (Standard model)	DC VOLTAGE	24V	48V	
	RATED CURRENT	16.7A	8.3A	
	RATED OUTPUT POWER	400W max.		
	VOLTAGE ADJ. RANGE	22.8 ~ 25.2V	45.6 ~ 50.4V	
	RIPPLE & NOISE (max.) Note.2	240mVp-p	360mVp-p	
	VOLTAGE TOLERANCE Note.3	± 1.0%	± 1.0%	
	LINE REGULATION	± 0.5%	± 0.5%	
	LOAD REGULATION	± 1.0%	± 1.0%	
	SETUP, RISE TIME	1000ms, 50ms/230Vac ; 2000ms, 50ms/115Vac		
HOLD UP TIME (Typ.)	12ms@230Vac ; 12ms@115Vac			
MULTIPLE OUTPUT (Optional Model)	DC VOLTAGE	CH1 output 24V or 48V + NID DC modules for CH2,3,4		
	TOTAL OUTPUT POWER	CH2,3,4 output power can be flexible depending on NID selection. Combined power on all channels must not exceed 400W		
INPUT	VOLTAGE RANGE Note.4	90 ~ 264VAC	127 ~ 370VDC	
	FREQUENCY RANGE	47 ~ 63Hz		
	POWER FACTOR	PF>0.95/230VAC PF>0.98/115VAC at full load		
	EFFICIENCY(Typ.) Note.5	88.5%, full case load with each type of module at nominal voltage		
	AC CURRENT	2.5A/230VAC	4.7A/115VAC	
	INRUSH CURRENT	40A/230VAC	25A/115VAC	
	LEAKAGE CURRENT	Earth leakage current <300uA / 264VAC, Touch current <100uA/264VAC		
PROTECTION	OVERLOAD	105 ~ 135% rated output power Protection type CH1: constant current limiting protection (If a long short circuit continues, the OTP action will be triggered), CH2,CH3,CH4: Hiccup mode protection		
	OVER VOLTAGE	26.4 ~ 31.2V	52.8 ~ 62.4V	
	OVER TEMPERATURE	Shut down o/p voltage, re-power on to recover		
ENVIRONMENT	WORKING TEMP.	-30 ~ +70°C (Refer to "Derating Curve")		
	WORKING HUMIDITY	20 ~ 90% RH non-condensing		
	STORAGE TEMP.	-40 ~ +85°C		
	TEMP. COEFFICIENT	±0.03%/°C (0 ~ 50°C)		
	VIBRATION	10~500Hz, 2G 10min./1 cycle, 60 min. each along X, Y, Z axes		
	OPERATING ALTITUDE Note.6	5000 meters /OVC II		
OVER VOLTAGE GATEGORY	III ; According to IEC62368-1; altitude up to 2000 meters			
SAFETY & EMC (Note 7)	SAFETY STANDARDS	EAC TP TC 004; UL62368-1, Dekra seal BS EN/EN62368-1 approved; Design refer to ANSI/AAMI ES60601-1, TUV BS EN/EN60601-1, IEC 60601-1 (3 rd edition)		
	ISOLATION LEVEL	Primary-Secondary: 2x MOPP, Primary-Earth: 1x MOPP		
	WITHSTAND VOLTAGE	I/P-O/P: 4KVAC I/P-FG: 2KVAC O/P-FG: 1.5KVAC		
	ISOLATION RESISTANCE	I/P-O/P, I/P-FG, O/P-FG: 100M Ohms / 500VDC / 25°C / 70% RH		
	EMC EMISSION	Parameter	Standard	Test Level / Note
		Conducted	BS EN/EN55032 (CISPR32) / Design refer to BS EN/EN55011 (CISPR11) Class B	
		Radiated	BS EN/EN55032 (CISPR32) / Design refer to BS EN/EN55011 (CISPR11) Class B	
		Harmonic Current	BS EN/EN61000-3-2 Class A	
	Voltage Flicker	BS EN/EN61000-3-3 -----		
	EMC IMMUNITY	Parameter	Standard	Test Level / Note
ESD		BS EN/EN61000-4-2 Level 4, 8KV air; Level 4, 4KV contact		
RF field		BS EN/EN61000-4-3 Level 3, 3V/m		
EFT/ Burst		BS EN/EN61000-4-4 Level 3, 1KV		
Surge		BS EN/EN61000-4-5 Level 4, 2KV/Line-FG; 1KV/Line-Line		
Conducted		BS EN/EN61000-4-6 Level 2, 3V		
Magnetic Field		BS EN/EN61000-4-8 Level 1, 1A/m		
Voltage Dips and Interruptions		BS EN/EN61000-4-11 100% dip 1 periods, 30% dip 25 periods, 100% interruptions 250 periods		
OTHERS	MTBF	1428.4K hrs min. Telcordia SR-332 (Bellcore) ; 187.3K hrs min. MIL-HDBK-217F (25°C)		
	DIMENSION	250*89*37mm (L*W*H)		
	PACKING	0.88Kg; 14pcs/13Kg/0.89CUFT		
NOTE	<p>1. All parameters NOT specifically mentioned are measured at 230VAC input, rated load and 25°C of ambient temperature.</p> <p>2. Ripple & noise are measured at 20MHz of bandwidth by using a 12" twisted pair-wire terminated with a 0.1 μf & 47 μf parallel capacitor.</p> <p>3. Tolerance: includes set up tolerance, line regulation and load regulation.</p> <p>4. De-rating may be needed under low input voltages. Please check the derating curve for more details.</p> <p>5. The efficiency changes by installing different output modules.</p> <p>6. The ambient temperature derating of 3.5°C/1000m with fanless models and of 5°C/1000m with fan models for operating altitude higher than 2000m (6500ft).</p> <p>7. The power supply is considered a component which will be installed into a final equipment. All the EMC tests are been executed by mounting the unit on a 450mm*450mm metal plate with 3mm of thickness. The final equipment must be re-confirmed that it still meets EMC directives. For guidance on how to perform these EMC tests, please refer to "EMI testing of component power supplies." (as available on http://www.meanwell.com)</p> <p>※ Product Liability Disclaimer : For detailed information, please refer to https://www.meanwell.com/serviceDisclaimer.aspx</p>			

■ BLOCK DIAGRAM

PFC : 65KHz
PWM : 85KHz

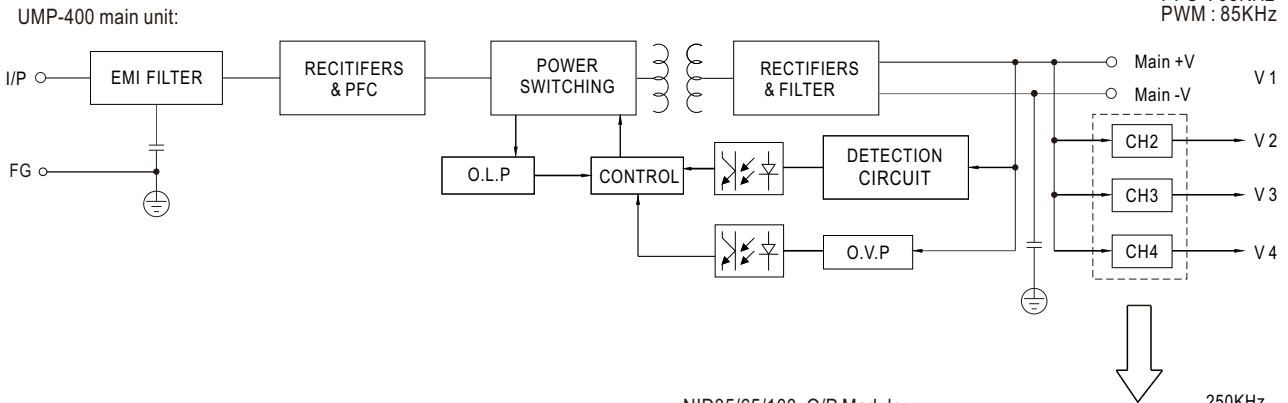

NID35/65/100 O/P Module:

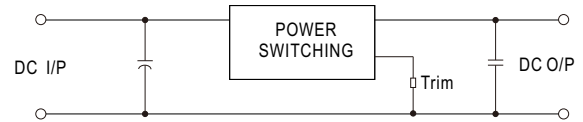

■ Derating Curve

⊙ Operate without cooling plate

UMP-400-24/48 (Single Output):

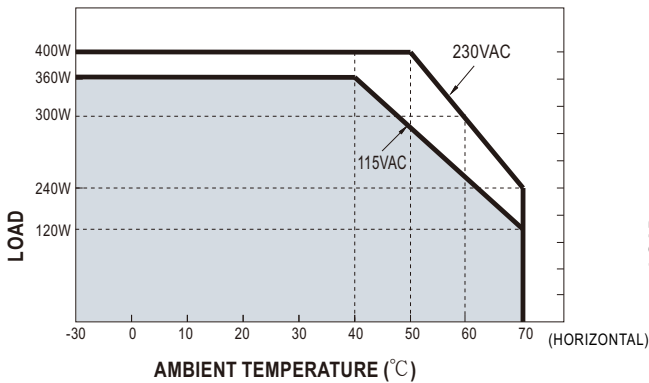

UMP-400-24/48XXX (Multi-channels):

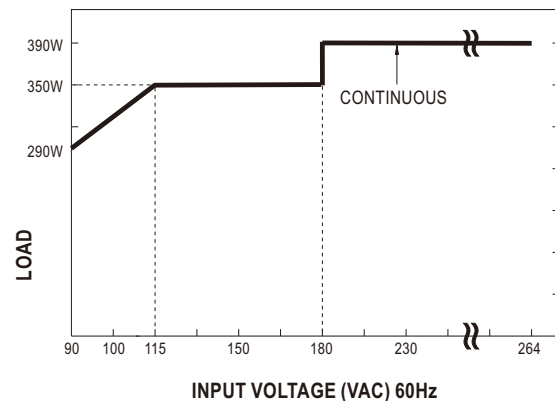
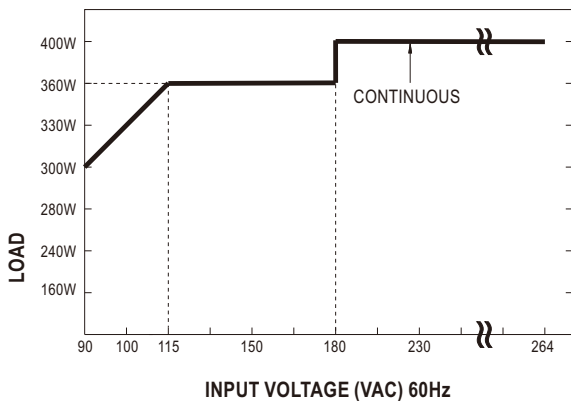
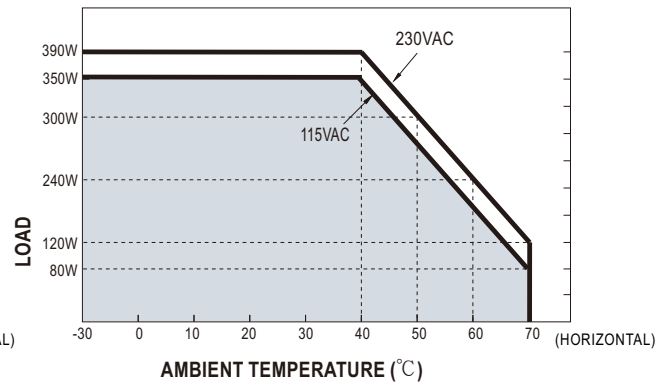

⊙ **Operate with cooling plate**

The UMP can operate under an extended temperature range with the addition of a 450x450x3mm aluminum plate.

Unit:mm

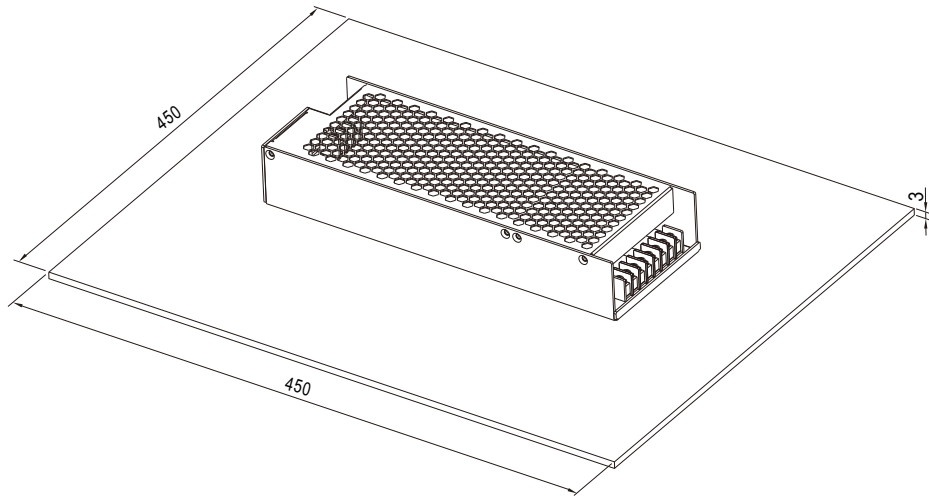

UMP-400-24/48 (Single Output):

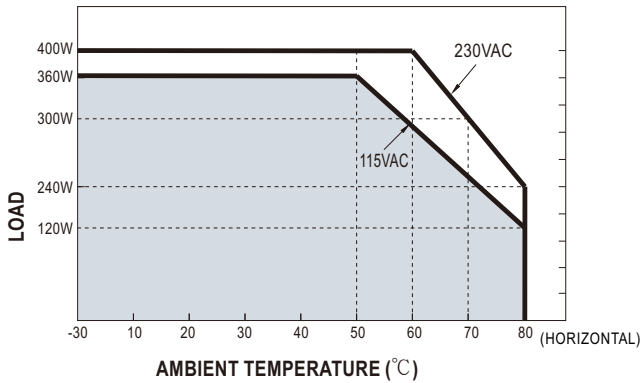

UMP-400-24/48XXX (Multi-channels):

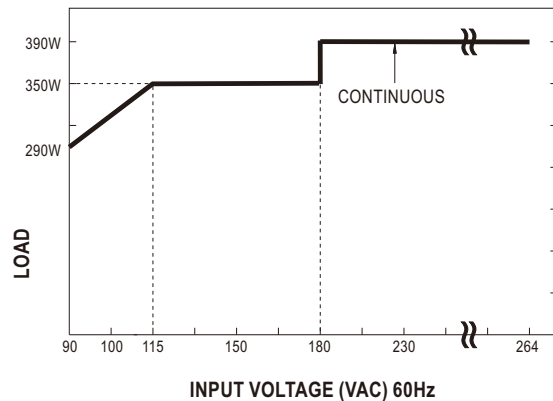
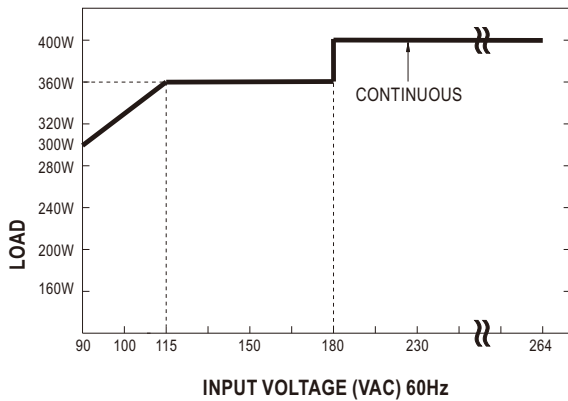
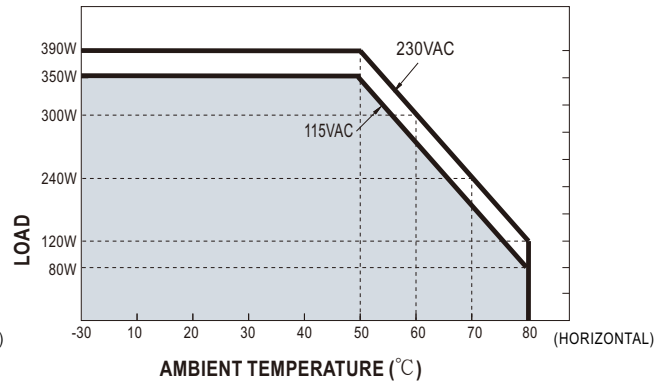

MECHANICAL SPECIFICATION

Case No.274

Unit:mm

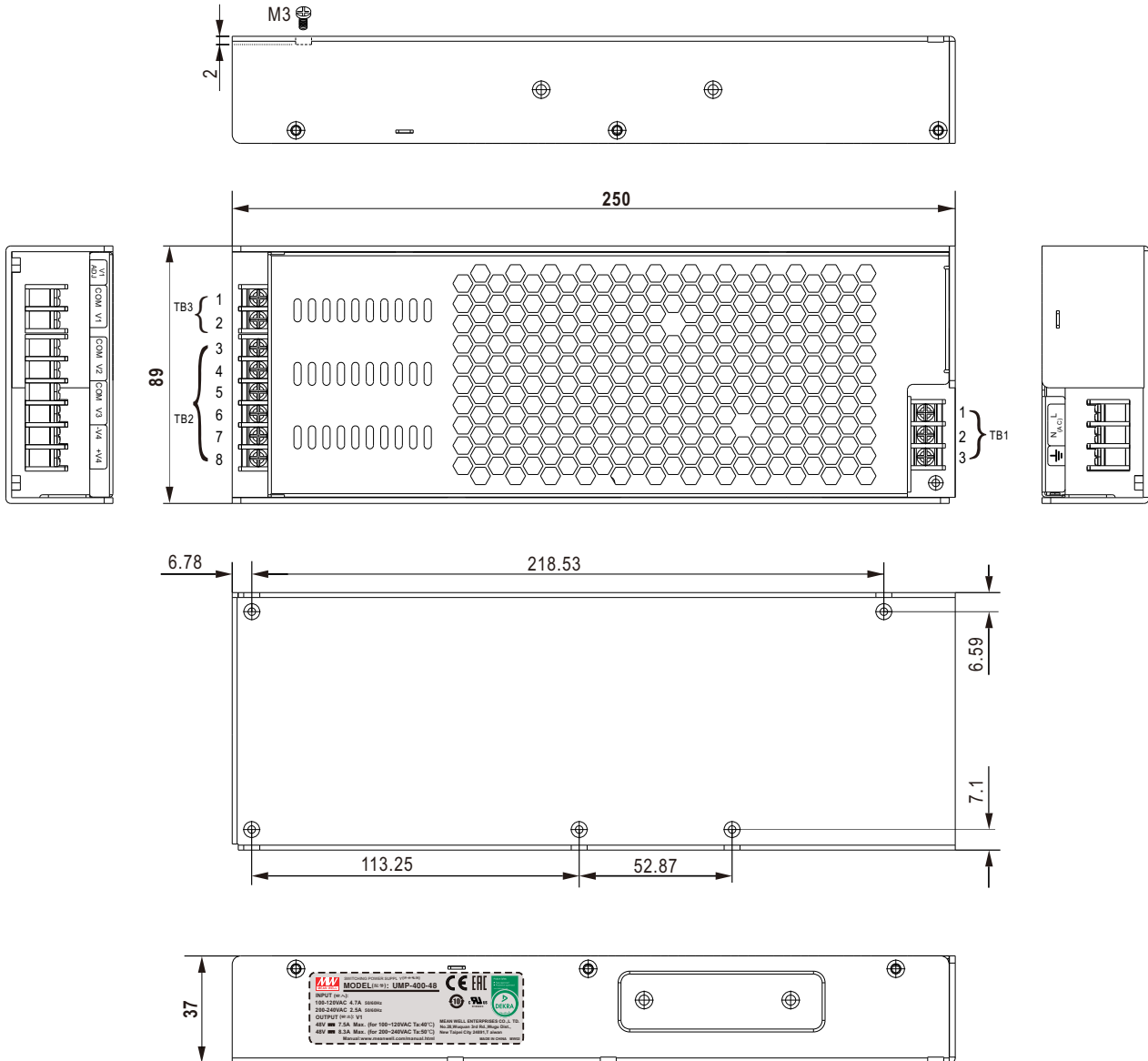

Terminal Pin No. Assignment

TB1

Pin No.	Assignment	Screw Size	Maximum mounting torque
1	AC/L	M3	14Kgf-cm
2	AC/N		
3	FG \perp		

TB3 (Single output UMP-400-24/48)

Pin No.	Assignment	Screw Size	Maximum mounting torque
1	COM	M3	14Kgf-cm
2	+V1		

TB2 (Multi-Channels UMP-400-24/48XXX)

Pin No.	Assignment	Screw Size	Maximum mounting torque
3	COM	M3	14Kgf-cm
4	+V2		
5	COM		
6	+V3		

Pin No.	positive voltage	negative voltage	Screw Size	Maximum mounting torque
7	COM	-V4	M3	14Kgf-cm
8	+V4	COM		

NOTE:

1. Only output channel 4(V4) may be configured as negative voltage.
2. When V4 is configured as positive output, Pin7 of TB2 is the common ground reference(COM).
When V4 is configured as negative voltage, Pin8 of TB2 is the common ground reference(COM).
3. TB2 is installed only when multiple output sets are selected.

■ Installation Instruction

For heat dissipation, at least 5cm installation clearance keep-out area around the PSU should be kept and the top side must be face up, shown as below:

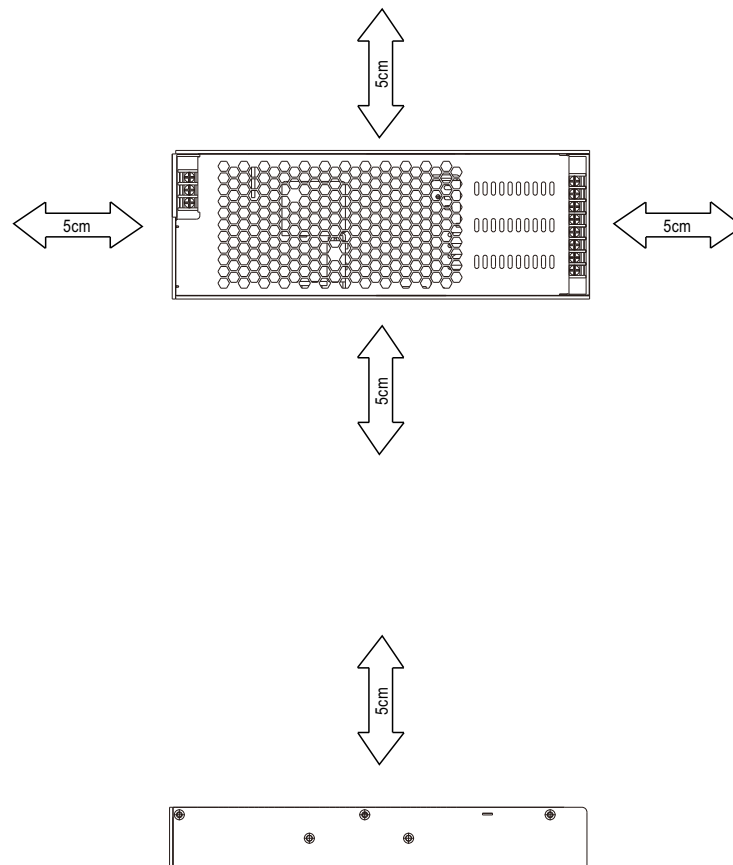
**■ Installation Manual**

Please refer to : <http://www.meanwell.com/manual.html>