

ITEM	Q'TY	PART NUMBER	PART DESCRIPTION
1	1	MPR3	Chrome Panel Mount Holder, 3mm
2	1	3XX-F	T-1 (3mm) Flanged LED, See Following Pages

REV.	DESCRIPTION	DATE	APPROVED
A	Engineering Release.	10/31/03	M. C.
B	Engineering Update w/o Changes.	04/07/05	M. C.
C	Dimension Update	07/10/06	M. C.
D	Updated Specs	04/03/09	T. Y.
E	Updated Specs	04/26/12	T. Y.
F	Updated LED offering	05/03/12	T. Y.
G	Updated Bi-Color Polarity Table	12/18/12	T. Y.
H	Updated LED Optical Characteristics	09/15/15	J. C.

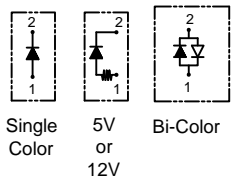
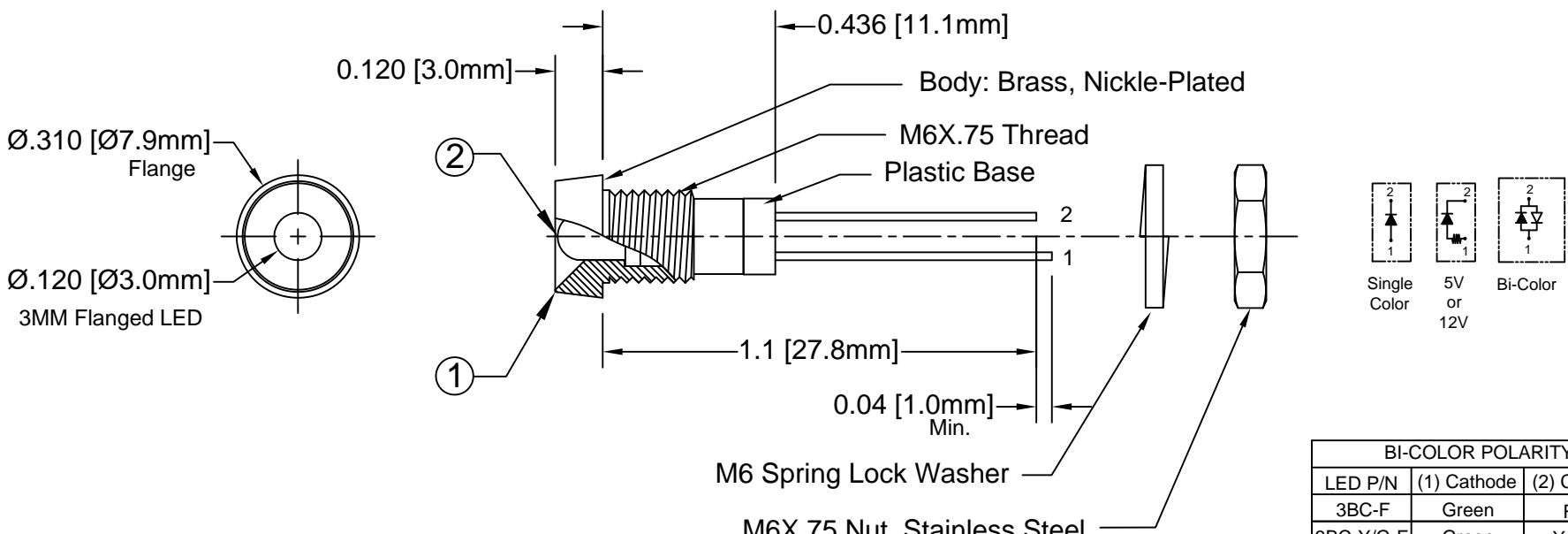

BI-COLOR POLARITY		
LED P/N	(1) Cathode	(2) Cathode
3BC-F	Green	Red
3BC-Y/G-F	Green	Yellow
3BC-R/Y-F	Yellow	Red
3BC-A/G-F	Green	Amber

(Mounting Hardware included, packed separately)

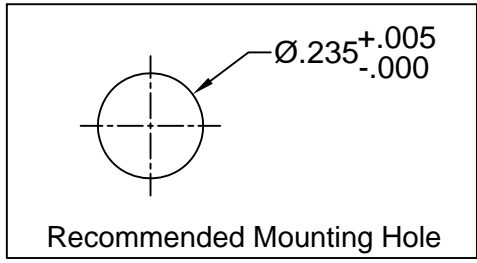

ABSOLUTE MAXIMUM RATINGS (Ta = 25°C)

- REVERSE VOLTAGE _____ 5V
- REVERSE CURRENT (VR=5V) _____ 100µA
- OPERATING TEMPERATURE RANGE _____ -25°C ~ 85°C
- STORAGE TEMPERATURE _____ -30°C ~ 100°C
- LEAD SOLDERING TEMPERATURE (1/16" FROM BODY) _____ 260°C for 5 Seconds



STANDARD TOLERANCE (UNLESS OTHERWISE SPECIFIED)	
DECIMALS	ANGULAR
.X ± .1	X° ± 1°
.XX ± .02	
.XXX ± .010	

BIVAR[®]
 4 THOMAS, IRVINE, CA. 92618
 TEL: (949) 951-8808 FAX: (949) 951-3974

DESIGNED: David Green	DATE: 02/14/03	TITLE: STD METAL PANEL MOUNT INDICATORS	REVISION: H
CHECKED: M. Chen	DATE: 02/14/03		PART NO: MPR3XX
CAGE CODE : 32559		SHEET # 1 OF 4	
CAD GENERATED DOCUMENT. DO NOT MEASURE DRAWING.			

REV.	DESCRIPTION	DATE	APPROVED
	SEE SHEET #1.		

LED Assy. No.	Chip			Lens Appearance	Electro-Optical Data @ 20mA				Viewing Angle 2 θ ½ (Deg)	LED P/N	
	Material	Peak Wave Length	Emitted Color		If (mA)	Vf (V)		Iv (mcd)			
						MAX	TYP	MAX			TYP
MPR3BWC	GaN/SiC	430	BLUE	WATER CLEAR	25	4	4.5	15	20	3BWC-F	
MPR3BWD	GaN/SiC	430	BLUE	DIFFUSED	25	4	4.5	10	35	3BWD-F	
MPR3BWT	GaN/SiC	430	BLUE	TINTED	25	4	4.5	15	20	3BWT-F	
MPR3GC	GaP/GaP	568	GREEN	WATER CLEAR	30	2.1	2.8	40	20	3GC-F	
MPR3GD	GaP/GaP	568	GREEN	DIFFUSED	30	2.1	2.8	25	35	3GD-F	
MPR3GT	GaP/GaP	568	GREEN	TINTED	30	2.1	2.8	40	20	3GT-F	
MPR3PGC	GaP/GaP	555	PURE GREEN	WATER CLEAR	30	2.2	2.8	10	20	3PGC-F	
MPR3PGD	GaP/GaP	555	PURE GREEN	DIFFUSED	30	2.2	2.8	5	35	3PGD-F	
MPR3PGT	GaP/GaP	555	PURE GREEN	TINTED	30	2.2	2.8	10	20	3PGT-F	
MPR3YC	GaAsP/GaP	590	YELLOW	WATER CLEAR	30	2	2.8	40	20	3YC-F	
MPR3YD	GaAsP/GaP	590	YELLOW	DIFFUSED	30	2	2.8	20	35	3YD-F	
MPR3YT	GaAsP/GaP	590	YELLOW	TINTED	30	2	2.8	40	20	3YT-F	
MPR3AC	GaAsP/GaP	605	AMBER	WATER CLEAR	30	2	2.8	40	20	3AC-F	
MPR3AD	GaAsP/GaP	605	AMBER	DIFFUSED	30	2	2.8	25	35	3AD-F	
MPR3AT	GaAsP/GaP	605	AMBER	TINTED	30	2	2.8	40	20	3AT-F	
MPR3HC	GaAsP/GaP	625	HE RED	WATER CLEAR	30	2	2.8	50	20	3HC-F	
MPR3HD	GaAsP/GaP	625	HE RED	DIFFUSED	30	2	2.8	30	35	3HD-F	
MPR3HT	GaAsP/GaP	625	HE RED	TINTED	30	2	2.8	50	20	3HT-F	
MPR3RC	GaP/GaP	700	RED	WATER CLEAR	20	2.1	2.8	2.5	35	3RC-F	
MPR3RD	GaP/GaP	700	RED	DIFFUSED	20	2.1	2.8	2	20	3RD-F	
MPR3RT	GaP/GaP	700	RED	TINTED	20	2.1	2.8	2.5	20	3RT-F	
MPR3BC-A/G	GaAsP/GaP	605	AMBER	DIFFUSED	30	2.0	2.8	6	45	3BC-A/G-F	
	GaP/GaP	568	GREEN		30	2.1	2.8	6			
MPR3BC	GaAsP/GaP	625	RED	DIFFUSED	30	2.0	2.8	6	45	3BC-F	
	GaP/GaP	568	GREEN		30	2.1	2.8	6			
MPR3BC-R/Y	GaAsP/GaP	625	RED	DIFFUSED	30	2.0	2.8	6	45	3BC-R/Y-F	
	GaAsP/GaP	590	YELLOW		30	2.0	2.8	4			
MPR3BC-Y/G	GaAsP/GaP	590	YELLOW	DIFFUSED	30	2.0	2.8	4	45	3BC-Y/G-F	
	GaP/GaP	568	GREEN		30	2.1	2.8	6			

STANDARD TOLERANCE (UNLESS OTHERWISE SPECIFIED) ±10% ALL VALUES ANGULAR X° ± 5°		 4 THOMAS, IRVINE, CA. 92618 TEL: (949) 951-8808 FAX: (949) 951-3974	
			
DESIGNED: David Green	DATE: 02/14/03	PART NO: MPR3XX	REVISION: H
CHECKED: M. Chen	DATE: 02/14/03	CAGE CODE : 32559	SHEET # 2 OF 4
CAD GENERATED DOCUMENT. DO NOT MEASURE DRAWING.			

REV.	DESCRIPTION	DATE	APPROVED
	SEE SHEET #1.		

LED Assy. No.	Chip			Lens Appearance	Electro-Optical Data @ 20mA				Viewing Angle 2 θ ½ (Deg)	LED P/N	
	Material	Peak Wave Length	Emitted Color		If (mA)	Vf (V)		Iv (mcd)			
						MAX	TYP	MAX			TYP
MPR3UBWC	GaN/SiC	470	BLUE	WATER CLEAR	30	4	4.5	400	30	3UBWC-0.6K-F	
MPR3SGC	GaP/GaP	568	GREEN	WATER CLEAR	30	2.1	2.8	50	20	3SGC-F	
MPR3SGD	GaP/GaP	568	GREEN	DIFFUSED	30	2.1	2.8	30	35	3SGD-F	
MPR3SGT	GaP/GaP	568	GREEN	TINTED	30	2.1	2.8	50	20	3SGT-F	
MPR3SYC	GaAsP/GaP	590	YELLOW	WATER CLEAR	30	2.0	2.8	50	20	3SYC-F	
MPR3SYD	GaAsP/GaP	590	YELLOW	DIFFUSED	30	2.0	2.8	30	35	3SYD-F	
MPR3SYT	GaAsP/GaP	590	YELLOW	TINTED	30	2.0	2.8	50	20	3SYT-F	
MPR3SAC	AlGaInP	605	AMBER	WATER CLEAR	30	1.8	2.4	300	20	3SAC-F	
MPR3SAD	AlGaInP	605	AMBER	DIFFUSED	30	1.8	2.4	100	35	3SAD-F	
MPR3SAT	AlGaInP	605	AMBER	TINTED	30	1.8	2.4	300	20	3SAT-F	
MPR3SRC	GaAlAs/GaAs	645	SUPER RED	WATER CLEAR	30	1.7	2.4	60	20	3SRC-F	
MPR3SRD	GaAlAs/GaAs	645	SUPER RED	DIFFUSED	30	1.7	2.4	40	35	3SRD-F	
MPR3SRT	GaAlAs/GaAs	645	SUPER RED	TINTED	30	1.7	2.4	60	20	3SRT-F	
MPR3UGC	AlGaInP	570	GREEN	WATER CLEAR	30	2.1	2.4	200	20	3UGC-F	
MPR3UGC	AlGaInP	570	GREEN	WATER CLEAR	30	2.1	2.4	300	35	3UGC-F	
MPR3UYC	AlGaInP	590	YELLOW	WATER CLEAR	30	2.0	2.4	300	20	3UYC-F	
MPR3UYC	AlGaInP	590	YELLOW	WATER CLEAR	30	2.0	2.4	400	20	3UYC-F	
MPR3UUYC	AlGaInP	590	YELLOW	WATER CLEAR	30	2.0	2.4	600	35	3UUYC-F	
MPR3UOC	AlGaInP	625	ORANGE	WATER CLEAR	30	1.8	2.4	300	20	3UOC-F	
MPR3SUOC	AlGaInP	625	ORANGE	WATER CLEAR	30	1.8	2.4	400	20	3SUOC-F	
MPR3URC	GaAlAs/GaAs	645	RED	WATER CLEAR	30	1.7	2.4	200	35	3URC-F	
MPR3SURC	AlGaInP	640	RED	WATER CLEAR	30	1.8	2.4	200	20	3SURC-F	
MPR3UWC	InGaN/Sapphire	6500K	WHITE	WATER CLEAR	30	3.2	3.6	6000	35	3UWC1.035C-F	

STANDARD TOLERANCE (UNLESS OTHERWISE SPECIFIED) ±10% ALL VALUES		ANGULAR X° ± 5°		 4 THOMAS, IRVINE, CA. 92618 TEL: (949) 951-8808 FAX: (949) 951-3974
DESIGNED: David Green		DATE: 02/14/03		
CHECKED: M. Chen		DATE: 02/14/03		PART NO: MPR3XX
				REVISION: H
				CAGE CODE : 32559 SHEET # 3 OF 4
CAD GENERATED DOCUMENT. DO NOT MEASURE DRAWING.				

REV.	DESCRIPTION	DATE	APPROVED
	SEE SHEET #1.		

LED Assy. No.	Chip			Lens Appearance	Absolute Max. Ratings			Electro-Optical Data @ 2mA			Viewing Angle 2 θ ½ (Deg)	LED P/N
	Material	Peak Wave Length λp(nm)	Emitted Color		Pd (mW)	If (mA)	Peak If(mA)	Vf (V)		Iv (mcd)		
								TYP	MAX	TYP		
MPR3BWDL	GaN/siC	430	BLUE	DIFFUSED	20	7	-	3.8	4.2	2.5	35	3BWDL-F
MPR3GDL	GaP/GaP	568	GREEN	DIFFUSED	10	7	-	2.1	2.6	4.0	35	3GDL-F
MPR3PGDL	GaP/GaP	555	PURE GREEN	DIFFUSED	10	7	-	2.1	2.6	0.2	35	3PGDL-F
MPR3YDL	GaAsP/GaP	590	YELLOW	DIFFUSED	10	7	-	2.0	2.6	2.0	35	3YDL-F
MPR3ADL	GaAsP/GaP	605	AMBER	DIFFUSED	10	7	-	2.0	2.6	4.0	35	3ADL-F
MPR3HDL	GaAsP/GaP	625	HE RED	DIFFUSED	10	7	-	2.0	2.6	2.5	35	3HDL-F
MPR3RDL	GaP/GaP	700	RED	DIFFUSED	10	7	-	2.1	2.6	0.5	35	3RDL-F
MPR3SRDL	GaAlAs/GaAs	645	RED	DIFFUSED	10	7	-	2.0	-	8.0	35	3SRDL-F

LED Assy. No.	Peak Wave Length λp(nm)	Emitted Color	Lens Appearance	Electro-Optical Data				Viewing Angle 2 θ½ (Deg)	LED P/N
				If (mA)	Vf (V)		Iv (mcd)		
					MAX	TYP			
5 Volt				Data @ 5V					
MPR3BWD5V	BLUE	430	DIFFUSED	-	-	5	10	35	3BWD5V-F
MPR3GC5V	GREEN	568	WATER CLEAR	-	-	5	40	20	3GC5V-F
MPR3GD5V	GREEN	568	DIFFUSED	-	-	5	25	35	3GD5V-F
MPR3GT5V	GREEN	568	TINTED	-	-	5	40	20	3GT5V-F
MPR3AD5V	AMBER	605	DIFFUSED	-	-	5	25	35	3AD5V-F
MPR3HD5V	HE RED	625	DIFFUSED	-	-	5	30	35	3HD5V-F
MPR3RD5V	RED	700	DIFFUSED	-	-	5	2	35	3RD5V-F
MPR3YD5V	YELLOW	590	DIFFUSED	-	-	5	20	35	3YD5V-F
12 Volt				Data @ 12V					
MPR3GC12V	GREEN	568	WATER CLEAR	-	-	12	40	20	3GC12V-F
MPR3GD12V	GREEN	568	DIFFUSED	-	-	12	25	35	3GD12V-F
MPR3HC12V	HE RED	625	WATER CLEAR	-	-	12	50	20	3HC12V-F
MPR3HD12V	HE RED	625	DIFFUSED	-	-	12	30	35	3HD12V-F
MPR3RC12V	RED	700	WATER CLEAR	-	-	12	6	20	3RC12V-F
MPR3RD12V	RED	700	DIFFUSED	-	-	12	2	35	3RD12V-F
MPR3YC12V	YELLOW	590	WATER CLEAR	-	-	12	40	20	3YC12V-F
MPR3YD12V	YELLOW	590	DIFFUSED	-	-	12	25	35	3YD12V-F

STANDARD TOLERANCE (UNLESS OTHERWISE SPECIFIED) ±10% ALL VALUES		ANGULAR X° ± 5°		 4 THOMAS, IRVINE, CA. 92618 TEL: (949) 951-8808 FAX: (949) 951-3974
DESIGNED: David Green		DATE: 02/14/03		
CHECKED: M. Chen		DATE: 02/14/03		CAGE CODE : 32559
				SHEET # 4 OF 4 CAD GENERATED DOCUMENT. DO NOT MEASURE DRAWING.

Mouser Electronics

Authorized Distributor

Click to View Pricing, Inventory, Delivery & Lifecycle Information:

[BIVAR:](#)

[MPR3BWD](#) [MPR3GD](#) [MPR3YD](#) [MPR3YT](#) [MPR3AD](#) [MPR3HD](#) [MPR3RD](#) [MPR3GDL](#) [MPR3BC](#) [MPR3HDL](#)
[MPR3SURC](#) [MPR3BC-Y/G](#) [MPR3BC12VW12-ER](#) [MPR3BC12VW18-ER](#) [MPR3BCC5VW6-ER](#)