

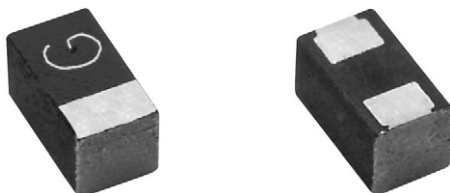

Solid Tantalum Chip Capacitors

298D MICROTAN[®], 298W Extended Range MICROTAN[®], Leadframeless Molded



FEATURES

- Small sizes include 0603 and 0402 footprint
- Lead (Pb)-free L-shaped face-down terminations
- 8 mm tape and reel packaging available per EIA-481 and reeling per IEC 60286-3 7" [178 mm] standard
- Mounting: surface mount
- Moisture sensitivity level 1 (for exceptions refer to "Standard Ratings" table)
- Material categorization: for definitions of compliance please see www.vishay.com/doc?99912



RoHS
COMPLIANT
HALOGEN
FREE
GREEN
(5-2008)

PERFORMANCE CHARACTERISTICS

Operating Temperature:

298D: -55 °C to +125 °C
(above 85 °C, voltage derating is required)

298W: -55 °C to +125 °C
(above 40 °C, voltage derating is required)

Capacitance Range:

298D: 0.33 μF to 220 μF

298W: 2.2 μF to 220 μF

Capacitance Tolerance: ± 20 % standard, ± 10 % available

Voltage Range: 2.5 V_{DC} to 50 V_{DC}

Note

- For further characteristics and recommended voltage derating guidelines see "Typical Performance Characteristics": www.vishay.com/doc?40169

ORDERING INFORMATION						
298D	335	X0	010	M	2	T
TYPE	CAPACITANCE	CAPACITANCE TOLERANCE	DC VOLTAGE RATING	CASE CODE	TERMINATION	REEL SIZE AND PACKAGING
298D 298W	This is expressed in picofarads. The first two digits are the significant figures. The third is the number of zeros to follow.	X0 = ± 20 % X9 = ± 10 %	This is expressed in volts. To complete the three-digit block, zeros precede the voltage rating. A decimal point is indicated by an "R" (6R3 = 6.3 V).	See Ratings and Case Codes table	2 = 100 % tin 4 = gold plated	T = tape and reel 7" [178 mm] reel D = tape and reel 7" [178 mm] reel, dry pack

Notes

- Preferred tolerance and termination / packaging types are in bold.
We reserve the right to supply higher voltage ratings and tighter capacitance tolerance capacitors in the same case size.
Voltage substitutions will be marked with the higher voltage rating
- Dry pack as specified in J-STD-033 for MSL 3 (available for selected part numbers)



DIMENSIONS in inches [millimeters]

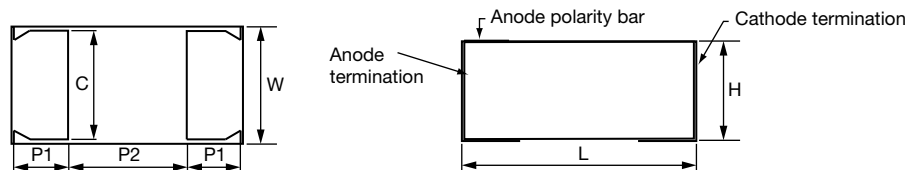

CASE CODE	L	W	H (MAX.)	P1	P2 (REF.)	C
K	0.039 + 0.008 [1.0 + 0.2]	0.020 + 0.008 [0.5 + 0.2]	0.024 [0.6]	0.01 ± 0.004 [0.25 ± 0.1]	0.02 [0.5]	0.015 ± 0.004 [0.38 ± 0.1]
M	0.063 ± 0.008 [1.60 ± 0.2]	0.033 ± 0.008 [0.85 ± 0.2]	0.035 [0.9]	0.020 ± 0.004 [0.50 ± 0.1]	0.024 [0.60]	0.024 ± 0.004 [0.60 ± 0.1]
S	0.079 ± 0.008 [2.00 ± 0.20]	0.050 ± 0.008 [1.25 ± 0.20]	0.035 [0.9]	0.020 ± 0.004 [0.50 ± 0.10]	0.040 [1.00]	0.035 ± 0.004 [0.90 ± 0.10]
R	0.081 ± 0.006 [2.06 ± 0.15]	0.053 ± 0.006 [1.35 ± 0.15]	0.062 [1.57]	0.020 ± 0.004 [0.51 ± 0.1]	0.043 [1.1]	0.035 ± 0.004 [0.90 ± 0.1]
P	0.094 ± 0.004 [2.4 ± 0.1]	0.057 ± 0.004 [1.45 ± 0.1]	0.047 [1.2]	0.020 ± 0.004 [0.50 ± 0.1]	0.057 [1.40]	0.035 ± 0.004 [0.90 ± 0.1]
Q	0.126 ± 0.008 [3.2 ± 0.2]	0.063 ± 0.008 [1.6 ± 0.2]	0.039 [1.0]	0.031 ± 0.004 [0.80 ± 0.1]	0.063 [1.60]	0.047 ± 0.004 [1.20 ± 0.1]
A	0.126 ± 0.008 [3.2 ± 0.2]	0.063 ± 0.008 [1.6 ± 0.2]	0.071 [1.8]	0.031 ± 0.004 [0.80 ± 0.1]	0.063 [1.60]	0.047 ± 0.004 [1.20 ± 0.1]

RATINGS AND CASE CODES (298D, 298W Extended Range)

µF	2.5 V		4 V		6.3 V		10 V		16 V		20 V	25 V	35 V	50 V
	298D	298D	298W	298D	298W	298D	298W	298D	298W	298D	298D	298D	298D	298D
0.33											K			
0.68											M	M		
1.0				K		K / M		K / M		M / S	R / S			P
1.5						M								
2.2				K / M		K / M		M	K				P	
3.3				M		M								
4.7		K		M		M / P	K	M / P		P	P			
10		K / M		M / S	K	M		R				A		
15		K		M		M								
22	K	K / M		M		M								
33		M		M		P	M							
47	M	M		R / P / A	M	P								
100		P	M	P / Q / A			A ⁽¹⁾							
220	P	P / Q	Q											

Note

⁽¹⁾ Rating under development



STANDARD RATINGS (298D, 298W Extended Range)						
CAPACITANCE (μ F)	CASE CODE	PART NUMBER	MAX. DCL AT +25 °C (μ A)	MAX. DF AT +25 °C (%)	MAX. ESR AT +25 °C 100 kHz (Ω)	MAX. RIPPLE 100 kHz I_{RMS} (A)
6.3 V_{DC} AT +85 °C; 4 V_{DC} AT +125 °C - 298D 6.3 V_{DC} AT +40 °C; 4.0 V_{DC} AT +85 °C; 2.5 V_{DC} AT +125 °C - 298W						
1.0	K	298D105X06R3K(2)T	0.5	6	20.00	0.027
2.2	K	298D225X06R3K(2)T	0.5	8	20.00	0.027
2.2	M	298D225(1)6R3M(2)T	0.5	10	5.00	0.070
3.3	M	298D335(1)6R3M(2)T	0.5	8	6.00	0.090
4.7	M	298D475(1)6R3M(2)T	0.5	8	3.00	0.090
10	M	298D106(1)6R3M(2)T	0.6	8	5.00	0.071
10	S	298D106X06R3S(2)T	0.6	8	5.00	0.084
10	K	298W106X06R3K(2)T	10	30	15.00	0.032
15	M	298D156X06R3M(2)T	1.0	20	7.00	0.060
22	M	298D226X06R3M(2)T	2.8	20	5.50	0.067
33	M	298D336X06R3M(2)T	4.2	30	7.50	0.058
47	M	298W476X06R3M(2)T	29.6	45	10.00	0.050
47	R	298D476X06R3R(2)T	3.0	25	3.00	0.122
47	P	298D476X06R3P(2)T	3.0	22	3.00	0.122
47	A	298D476X06R3A(2)T	3.0	10	2.00	0.150
100	P	298D107(1)6R3P(2)T	6.3	30	2.00	0.150
100	Q	298D107X06R3Q(2)T	10	30	1.10	0.220
100	A	298D107X06R3A(2)T	6.3	20	1.00	0.270
10 V_{DC} AT +85 °C; 7 V_{DC} AT +125 °C - 298D 10 V_{DC} AT +40 °C; 6.3 V_{DC} AT +85 °C; 4.0 V_{DC} AT +125 °C - 298W						
1.0	K	298D105X0010K(2)T	0.5	6	20.00	0.027
1.0	M	298D105(1)010M(2)T	0.5	6	12.00	0.045
1.5	M	298D155(1)010M(2)T	0.5	6	14.00	0.040
2.2	K	298D225X0010K(2)T	2.2	8	15.00	0.027
2.2	M	298D225X0010M(2)T	0.5	10	10.00	0.050
3.3	M	298D335(1)010M(2)T	0.5	8	6.00	0.090
4.7	K	298W475X0010K(2)T	10	50	50.00	0.017
4.7	M	298D475(1)010M(2)T	0.5	6	5.00	0.071
4.7	P	298D475(1)010P(2)T	0.5	6	4.00	0.106
10	M	298D106(1)010M(2)T	1.0	20	7.50	0.058
15	M	298D156X0010M(2)T	1.5	30	7.50	0.058
22	M	298D226X0010M(2)T	2.2	40	10.00	0.050
33	M	298W336X0010M(2)T	66	75	21.00	0.035
33	P	298D336X0010P(2)T	3.3	20	4.00	0.150
47	P	298D476X0010P(2)T	4.7	22	3.00	0.122
100	A	298W107X0010A(2)D ⁽¹⁾⁽²⁾	TBD	TBD	TBD	TBD
16 V_{DC} AT +85 °C; 10 V_{DC} AT +125 °C - 298D 16 V_{DC} AT +40 °C; 10 V_{DC} AT +85 °C; 6.3 V_{DC} AT +125 °C - 298W						
1.0	K	298D105X0016K(2)T	1.6	10	20.00	0.027
1.0	M	298D105(1)016M(2)T	0.5	6	12.00	0.045
2.2	K	298W225(1)016K(2)T	10	50	50.00	0.017
2.2	M	298D225(1)016M(2)T	0.5	10	12.00	0.045
4.7	M	298D475X0016M(2)T	0.8	12	12.00	0.046
4.7	P	298D475(1)016P(2)T	0.8	6	4.00	0.106
10	R	298D106(1)016R(2)T	1.6	8	8.00	0.075

Notes

- Part number definitions:

(1) Tolerance: for 10 % tolerance, specify "X9"; for 20 % tolerance, change to "X0"

(2) Termination: for 100 % tin specify "2", for gold plated specify "4"

(1) Rating is MSL 3

(2) Part number 298W107X0010A(2)D is under development, please consult with factory for availability and specifications



STANDARD RATINGS (298D, 298W Extended Range)						
CAPACITANCE (μ F)	CASE CODE	PART NUMBER	MAX. DCL AT +25 °C (μ A)	MAX. DF AT +25 °C (%)	MAX. ESR AT +25 °C 100 kHz (Ω)	MAX. RIPPLE 100 kHz I_{RMS} (A)
20 V_{DC} AT +85 °C; 13 V_{DC} AT +125 °C						
0.33	K	298D334(1)020K(2)T	0.5	6	100.00	0.012
0.68	M	298D684(1)020M(2)T	0.5	6	20.00	0.042
1.0	S	298D105X0020S(2)T	0.5	6	10.00	0.059
1.0	M	298D105(1)020M(2)T	0.5	6	12.00	0.045
4.7	P	298D475(1)020P(2)T	1.0	6	4.00	0.106
25 V_{DC} AT +85 °C; 17 V_{DC} AT +125 °C						
0.68	M	298D684(1)025M(2)T	0.5	6	20.00	0.042
1.0	S	298D105X0025S(2)T	0.5	6	10.00	0.059
1.0	R	298D105(1)025R(2)T	0.5	6	10.00	0.067
4.7	P	298D475(1)025P(2)T	1.2	6	4.00	0.106
10	A	298D106(1)025A(2)T	2.5	10	3.50	0.146
35 V_{DC} AT +85 °C; 23 V_{DC} AT +125 °C						
2.2	P	298D225X0035P(2)T	0.8	8	8.00	0.075
50 V_{DC} AT +85 °C; 33 V_{DC} AT +125 °C						
1.0	P	298D105X0050P(2)T	0.5	8	8.00	0.075

Notes

- Part number definitions:

(1) Tolerance: for 10 % tolerance, specify "X9"; for 20 % tolerance, change to "X0"

(2) Termination: for 100 % tin specify "2", for gold plated specify "4"

(1) Rating is MSL 3

(2) Part number 298W107X0010A(2)D is under development, please consult with factory for availability and specifications

STANDARD PACKAGING QUANTITY	
CASE CODE	QUANTITY (pcs/reel)
	7" REEL
K	5000
M	4000
S	3000
R	2500
P	3000
Q	2500
A	2000



POWER DISSIPATION	
CASE CODE	MAXIMUM PERMISSIBLE POWER DISSIPATION AT +25 °C (W) IN FREE AIR
K	0.015
M	0.025
S	0.035
R	0.045
P	0.045
Q	0.055
A	0.075

PRODUCT INFORMATION	
Micro Guide	www.vishay.com/doc?40115
Pad Dimensions	
Packaging Dimensions	
Moisture Sensitivity	www.vishay.com/doc?40135
Typical Performance Characteristics	www.vishay.com/doc?40169
Solid Tantalum Capacitors (With MnO ₂ Electrolyte) Voltage Derating	www.vishay.com/doc?40246
SELECTOR GUIDES	
Solid Tantalum Selector Guide	www.vishay.com/doc?49053
Solid Tantalum Chip Capacitors	www.vishay.com/doc?40091
FAQ	
Frequently Asked Questions	www.vishay.com/doc?40110



Guide for Leadframeless Molded Tantalum Capacitors

INTRODUCTION

Tantalum electrolytic capacitors are the preferred choice in applications where volumetric efficiency, stable electrical parameters, high reliability, and long service life are primary considerations. The stability and resistance to elevated temperatures of the tantalum / tantalum oxide / manganese dioxide system make solid tantalum capacitors an appropriate choice for today's surface mount assembly technology.

Vishay Sprague has been a pioneer and leader in this field, producing a large variety of tantalum capacitor types for consumer, industrial, automotive, military, and aerospace electronic applications.

Tantalum is not found in its pure state. Rather, it is commonly found in a number of oxide minerals, often in combination with Columbium ore. This combination is known as "tantallite" when its contents are more than one-half tantalum. Important sources of tantallite include Australia, Brazil, Canada, China, and several African countries. Synthetic tantallite concentrates produced from tin slags in Thailand, Malaysia, and Brazil are also a significant raw material for tantalum production.

Electronic applications, and particularly capacitors, consume the largest share of world tantalum production. Other important applications for tantalum include cutting tools (tantalum carbide), high temperature super alloys, chemical processing equipment, medical implants, and military ordnance.

Vishay Sprague is a major user of tantalum materials in the form of powder and wire for capacitor elements and rod and sheet for high temperature vacuum processing.

THE BASICS OF TANTALUM CAPACITORS

Most metals form crystalline oxides which are non-protecting, such as rust on iron or black oxide on copper. A few metals form dense, stable, tightly adhering, electrically insulating oxides. These are the so-called "valve" metals and include titanium, zirconium, niobium, tantalum, hafnium, and aluminum. Only a few of these permit the accurate control of oxide thickness by electrochemical means. Of these, the most valuable for the electronics industry are aluminum and tantalum.

Capacitors are basic to all kinds of electrical equipment, from radios and television sets to missile controls and automobile ignitions. Their function is to store an electrical charge for later use.

Capacitors consist of two conducting surfaces, usually metal plates, whose function is to conduct electricity. They are separated by an insulating material or dielectric. The dielectric used in all tantalum electrolytic capacitors is tantalum pentoxide.

Tantalum pentoxide compound possesses high-dielectric strength and a high-dielectric constant. As capacitors are being manufactured, a film of tantalum pentoxide is applied to their electrodes by means of an electrolytic process. The film is applied in various thicknesses and at various voltages and although transparent to begin with, it takes on different colors as light refracts through it. This coloring occurs on the tantalum electrodes of all types of tantalum capacitors.

Rating for rating, tantalum capacitors tend to have as much as three times better capacitance / volume efficiency than aluminum electrolytic capacitors. An approximation of the capacitance / volume efficiency of other types of capacitors may be inferred from the following table, which shows the dielectric constant ranges of the various materials used in each type. Note that tantalum pentoxide has a dielectric constant of 26, some three times greater than that of aluminum oxide. This, in addition to the fact that extremely thin films can be deposited during the electrolytic process mentioned earlier, makes the tantalum capacitor extremely efficient with respect to the number of microfarads available per unit volume. The capacitance of any capacitor is determined by the surface area of the two conducting plates, the distance between the plates, and the dielectric constant of the insulating material between the plates.

COMPARISON OF CAPACITOR DIELECTRIC CONSTANTS

DIELECTRIC	ϵ DIELECTRIC CONSTANT
Air or Vacuum	1.0
Paper	2.0 to 6.0
Plastic	2.1 to 6.0
Mineral Oil	2.2 to 2.3
Silicone Oil	2.7 to 2.8
Quartz	3.8 to 4.4
Glass	4.8 to 8.0
Porcelain	5.1 to 5.9
Mica	5.4 to 8.7
Aluminum Oxide	8.4
Tantalum Pentoxide	26
Ceramic	12 to 400K

In the tantalum electrolytic capacitor, the distance between the plates is very small since it is only the thickness of the tantalum pentoxide film. As the dielectric constant of the tantalum pentoxide is high, the capacitance of a tantalum capacitor is high if the area of the plates is large:

$$C = \frac{\epsilon A}{t}$$

where

C = capacitance

ϵ = dielectric constant

A = surface area of the dielectric

t = thickness of the dielectric

Tantalum capacitors contain either liquid or solid electrolytes. In solid electrolyte capacitors, a dry material (manganese dioxide) forms the cathode plate. A tantalum lead is embedded in or welded to the pellet, which is in turn connected to a termination or lead wire. The drawings show the construction details of the surface mount types of tantalum capacitors shown in this catalog.

SOLID ELECTROLYTE TANTALUM CAPACITORS

Solid electrolyte capacitors contain manganese dioxide, which is formed on the tantalum pentoxide dielectric layer by impregnating the pellet with a solution of manganous nitrate. The pellet is then heated in an oven, and the manganous nitrate is converted to manganese dioxide.

The pellet is next coated with graphite, followed by a layer of metallic silver, which provides a conductive surface between the pellet and the leadframe.

Molded chip tantalum capacitor encases the element in plastic resins, such as epoxy materials. The molding compound has been selected to meet the requirements of UL 94 V-0 and outgassing requirements of ASTM E-595. After assembly, the capacitors are tested and inspected to assure long life and reliability. It offers excellent reliability and high stability for consumer and commercial electronics with the added feature of low cost.

Surface mount designs of “Solid Tantalum” capacitors use lead frames or lead frameless designs as shown in the accompanying drawings.

TANTALUM CAPACITORS FOR ALL DESIGN CONSIDERATIONS

Solid electrolyte designs are the least expensive for a given rating and are used in many applications where their very small size for a given unit of capacitance is of importance. They will typically withstand up to about 10 % of the rated DC working voltage in a reverse direction. Also important are their good low temperature performance characteristics and freedom from corrosive electrolytes.

Vishay Sprague patented the original solid electrolyte capacitors and was the first to market them in 1956. Vishay Sprague has the broadest line of tantalum capacitors and has continued its position of leadership in this field. Data sheets covering the various types and styles of Vishay Sprague capacitors for consumer and entertainment electronics, industry, and military applications are available where detailed performance characteristics must be specified.

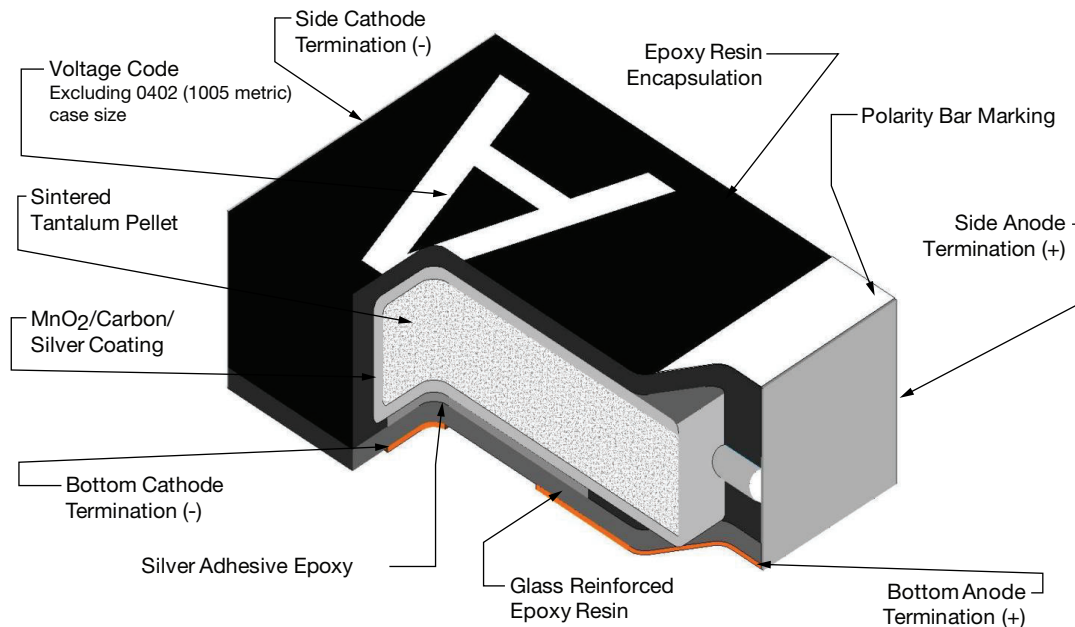
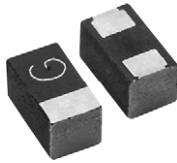
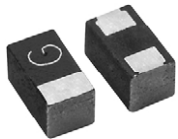

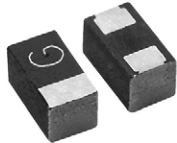
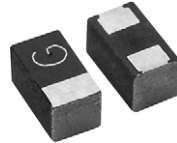
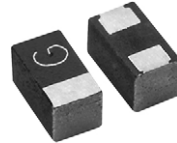
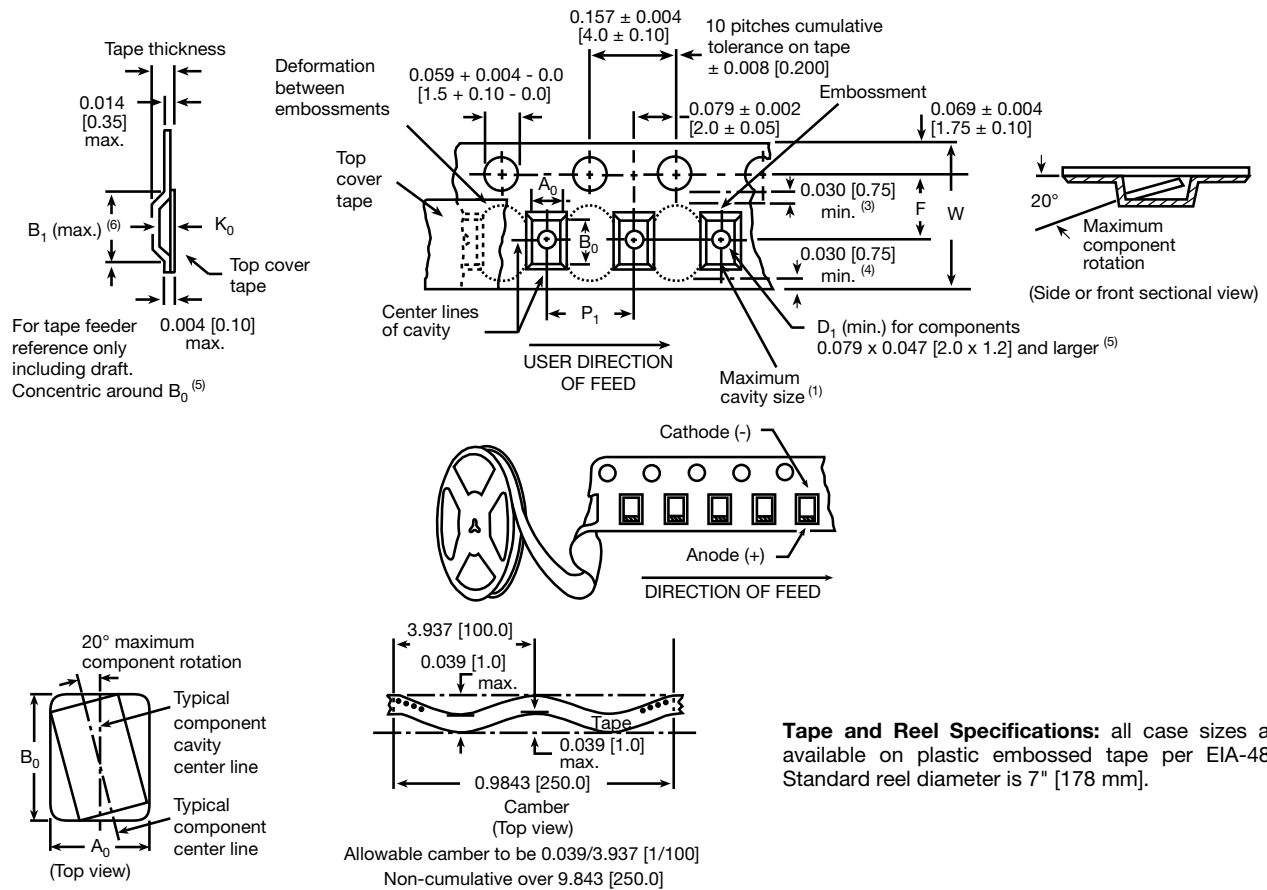

Fig. 1 - Leadframeless Molded Capacitors, All Types

SOLID TANTALUM CAPACITORS - LEADFRAMELESS MOLDED				
SERIES	TL8	298D	298W	TR8
PRODUCT IMAGE				
TYPE	Solid tantalum leadframeless molded chip capacitors			
FEATURES	Small size including 0603 and 0402 foot print			
	Ultra low profile	Industrial grade	Industrial grade, extended range	Low ESR
TEMPERATURE RANGE	Operating Temperature: -55 °C to +125 °C (above 40 °C, voltage derating is required)	Operating Temperature: -55 °C to +125 °C (above 85 °C, voltage derating is required)	Operating Temperature: -55 °C to +125 °C (above 40 °C, voltage derating is required)	Operating Temperature: -55 °C to +125 °C (above 85 °C, voltage derating is required)
CAPACITANCE RANGE	0.68 µF to 220 µF	0.33 µF to 220 µF	2.2 µF to 220 µF	1 µF to 220 µF
VOLTAGE RANGE	4 V to 25 V	2.5 V to 50 V	4 V to 16 V	2.5 V to 25 V
CAPACITANCE TOLERANCE	± 20 %, ± 10 %			
DISSIPATION FACTOR	6 % to 80 %	6 % to 80 %	30 % to 80 %	6 % to 80 %
CASE CODES	W9, A0, B0	K, M, R, P, Q, A, S, B	K, M, Q	M, R, P, Q, A, B
TERMINATION	100 % tin	100 % tin or gold plated		

SOLID TANTALUM CAPACITORS - LEADFRAMELESS MOLDED			
SERIES	TP8	TM8	DLA 11020
PRODUCT IMAGE			
TYPE	Solid tantalum leadframeless molded chip capacitors		
FEATURES	Small size including 0603 and 0402 foot print		
	High performance, automotive grade	High reliability	High reliability, DLA approved
TEMPERATURE RANGE	Operating Temperature: -55 °C to +125 °C (above 85 °C, voltage derating is required)		
CAPACITANCE RANGE	1 µF to 100 µF	0.68 µF to 47 µF	1 µF to 47 µF
VOLTAGE RANGE	6.3 V to 40 V	2 V to 40 V	6.3 V to 40 V
CAPACITANCE TOLERANCE	± 20 %, ± 10 %		
DISSIPATION FACTOR	6 % to 30 %	6 % to 20 %	6 % to 8 %
CASE CODES	M, W, R, P, A, N, T, B	K, M, G, W, R, P, A, N, T	M, W, R, P, A, N, T
TERMINATION	100 % tin	Tin / lead solder plated, 100 % tin and gold plated	Tin / lead solder plated or gold plated

PLASTIC TAPE AND REEL PACKAGING in inches [millimeters]



Notes

- Metric dimensions will govern. Dimensions in inches are rounded and for reference only
- (1) A₀, B₀, K₀, are determined by the maximum dimensions to the ends of the terminals extending from the component body and / or the body dimensions of the component. The clearance between the ends of the terminals or body of the component to the sides and depth of the cavity (A₀, B₀, K₀) must be within 0.002" (0.05 mm) minimum and 0.020" (0.50 mm) maximum. The clearance allowed must also prevent rotation of the component within the cavity of not more than 20°
- (2) Tape with components shall pass around radius "R" without damage. The minimum trailer length may require additional length to provide "R" minimum for 12 mm embossed tape for reels with hub diameters approaching N minimum
- (3) This dimension is the flat area from the edge of the sprocket hole to either outward deformation of the carrier tape between the embossed cavities or to the edge of the cavity whichever is less
- (4) This dimension is the flat area from the edge of the carrier tape opposite the sprocket holes to either the outward deformation of the carrier tape between the embossed cavity or to the edge of the cavity whichever is less
- (5) The embossed hole location shall be measured from the sprocket hole controlling the location of the embossment. Dimensions of embossment location shall be applied independent of each other
- (6) B₁ dimension is a reference dimension tape feeder clearance only

CARRIER TAPE DIMENSIONS in inches [millimeters] FOR 298D, 298W, TR8, TP8, TL8

CASE CODE	TAPE SIZE	B ₁ (MAX.) ⁽¹⁾	D ₁ (MIN.)	F	K ₀ (MAX.)	P ₁	W
M ⁽²⁾	8 mm	0.075 [1.91]	0.02 [0.5]	0.138 [3.5]	0.043 [1.10]	0.157 [4.0]	0.315 [8.0]
W	8 mm	0.112 [2.85]	0.039 [1.0]	0.138 [3.5]	0.053 [1.35]	0.157 [4.0]	0.315 [8.0]
R	8 mm	0.098 [2.46]	0.039 [1.0]	0.138 [3.5]	0.066 [1.71]	0.157 [4.0]	0.315 [8.0]
P	8 mm	0.108 [2.75]	0.02 [0.5]	0.138 [3.5]	0.054 [1.37]	0.157 [4.0]	0.315 [8.0]
A	8 mm	0.153 [3.90]	0.039 [1.0]	0.138 [3.5]	0.078 [2.00]	0.157 [4.0]	0.315 [8.0]
A0, Q	8 mm	-	0.02 [0.5]	0.138 [3.5]	0.049 [1.25]	0.157 [4.0]	0.315 [8.0]
B	8 mm	0.157 [4.0]	0.039 [1.0]	0.138 [3.5]	0.087 [2.22]	0.157 [4.0]	0.315 [8.0]
W9, S	8 mm	0.126 [3.20]	0.029 [0.75]	0.138 [3.5]	0.045 [1.15]	0.157 [4.0]	0.315 [8.0]
B0	12 mm	0.181 [4.61]	0.059 [1.5]	0.217 [5.5]	0.049 [1.25]	0.157 [4.0]	0.472 [12.0]

Notes

- (1) For reference only
- (2) Packaging of M case in plastic tape is available per request

CARRIER TAPE DIMENSIONS in inches [millimeters] FOR TM8							
CASE CODE	TAPE SIZE	B ₁ (MAX.) ⁽¹⁾	D ₁ (MIN.)	F	K ₀ (MAX.)	P ₁	W
M	8 mm	0.075 [1.91]	0.02 [0.5]	0.138 [3.5]	0.043 [1.10]	0.157 [4.0]	0.315 [8.0]
G	8 mm	0.077 [1.96]	0.02 [0.5]	0.138 [3.5]	0.051 [1.30]	0.157 [4.0]	0.315 [8.0]
W	8 mm	0.112 [2.85]	0.039 [1.0]	0.138 [3.5]	0.053 [1.35]	0.157 [4.0]	0.315 [8.0]
R	8 mm	0.098 [2.46]	0.039 [1.0]	0.138 [3.5]	0.066 [1.71]	0.157 [4.0]	0.315 [8.0]
P	8 mm	0.108 [2.75]	0.02 [0.5]	0.138 [3.5]	0.054 [1.37]	0.157 [4.0]	0.315 [8.0]
A	8 mm	0.153 [3.90]	0.039 [1.0]	0.138 [3.5]	0.078 [2.00]	0.157 [4.0]	0.315 [8.0]
N	12 mm	0.154 [3.90]	0.059 [1.5]	0.216 [5.5]	0.051 [1.30]	0.157 [4.0]	0.472 [12.0]
T	12 mm	0.154 [3.90]	0.059 [1.5]	0.216 [5.5]	0.067 [1.70]	0.157 [4.0]	0.472 [12.0]

Notes
⁽¹⁾ For reference only

PAPER TAPE AND REEL PACKAGING in inches [millimeters] FOR 298D, 298W, TR8, TP8, TL8, TM8 (K case only)											
CASE SIZE	TAPE SIZE	A ₀	B ₀	D ₀	P ₀	P ₁	P ₂	E	F	W	T
K	8 mm	0.033 ± 0.002 [0.85 ± 0.05]	0.053 ± 0.002 [1.35 ± 0.05]	0.06 ± 0.004 [1.5 ± 0.1]	0.157 ± 0.004 [4.0 ± 0.1]	0.078 ± 0.004 [2.0 ± 0.1]	0.079 ± 0.002 [2.0 ± 0.05]	0.069 ± 0.004 [1.75 ± 0.1]	0.0138 ± 0.002 [3.5 ± 0.05]	0.315 ± 0.008 [8.0 ± 0.2]	0.03 ± 0.002 [0.75 ± 0.05]
M	8 mm	0.041 ± 0.002 [1.05 ± 0.05]	0.071 ± 0.002 [1.8 ± 0.05]	0.06 ± 0.004 [1.5 ± 0.1]	0.157 ± 0.004 [4.0 ± 0.1]	0.157 ± 0.004 [4.0 ± 0.1]	0.079 ± 0.002 [2.0 ± 0.05]	0.069 ± 0.004 [1.75 ± 0.1]	0.0138 ± 0.002 [3.5 ± 0.05]	0.315 ± 0.008 [8.0 ± 0.2]	0.037 ± 0.002 [0.95 ± 0.05]

Note
⁽¹⁾ A₀, B₀ are determined by the maximum dimensions to the ends of the terminals extending from the component body and / or the body dimensions of the component. The clearance between the ends of the terminals or body of the component to the sides and depth of the cavity (A₀, B₀) must be within 0.002" (0.05 mm) minimum and 0.020" (0.50 mm) maximum. The clearance allowed must also prevent rotation of the component within the cavity of not more than 20°

RECOMMENDED REFLOW PROFILES

Capacitors should withstand reflow profile as per J-STD-020 standard, three cycles.

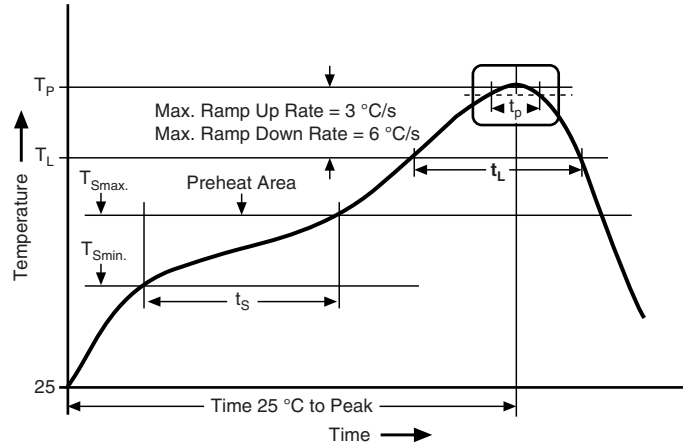

PROFILE FEATURE	SnPb EUTECTIC ASSEMBLY	LEAD (Pb)-FREE ASSEMBLY
PREHEAT AND SOAK		
Temperature min. ($T_{Smin.}$)	100 °C	150 °C
Temperature max. ($T_{Smax.}$)	150 °C	200 °C
Time (t_s) from ($T_{Smin.}$ to $T_{Smax.}$)	60 s to 90 s	60 s to 150 s
RAMP UP		
Ramp-up rate (T_L to T_p)	3 °C/s maximum	
Liquidus temperature (T_L)	183 °C	217 °C
Time (t_L) maintained above T_L	60 s to 150 s	
Peak package body temperature (T_p) max.	235 °C	260 °C
Time (t_p) within 5 °C of the peak max. temperature	20 s	30 s
RAMP DOWN		
Ramp-down rate (T_p to T_L)	6 °C/s maximum	
Time from 25 °C to peak temperature	6 min maximum	8 min maximum

PAD DIMENSIONS in inches [millimeters]

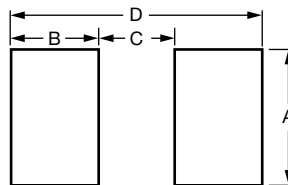

CASE CODE	A (NOM.)	B (MIN.)	C (NOM.)	D (MIN.)
K	0.021 [0.53]	0.016 [0.41]	0.022 [0.55]	0.054 [1.37]
M, G	0.024 [0.61]	0.027 [0.70]	0.025 [0.64]	0.080 [2.03]
R, W9, S	0.035 [0.89]	0.029 [0.74]	0.041 [1.05]	0.099 [2.52]
W	0.035 [0.89]	0.029 [0.74]	0.037 [0.95]	0.095 [2.41]
P	0.035 [0.89]	0.029 [0.74]	0.054 [1.37]	0.112 [2.84]
A, Q, A0	0.047 [1.19]	0.042 [1.06]	0.065 [1.65]	0.148 [3.76]
B, B0	0.094 [2.39]	0.044 [1.11]	0.072 [1.82]	0.159 [4.03]
N, T	0.094 [2.39]	0.044 [1.11]	0.065 [1.65]	0.152 [3.86]
M2	0.315 [8.00]	0.098 [2.50]	0.197 [5.00]	0.394 [10.0]



TYPICAL CURVES AT +25 °C, IMPEDANCE AND ESR VS. FREQUENCY

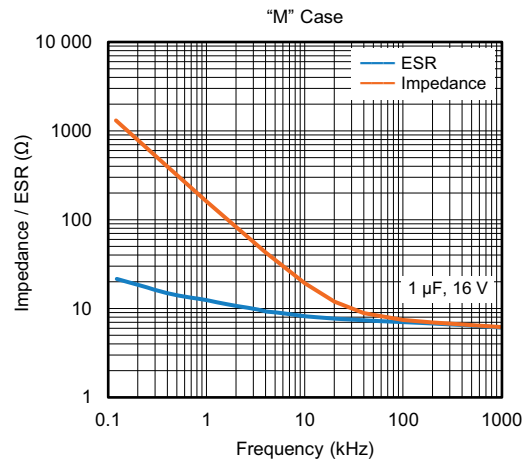
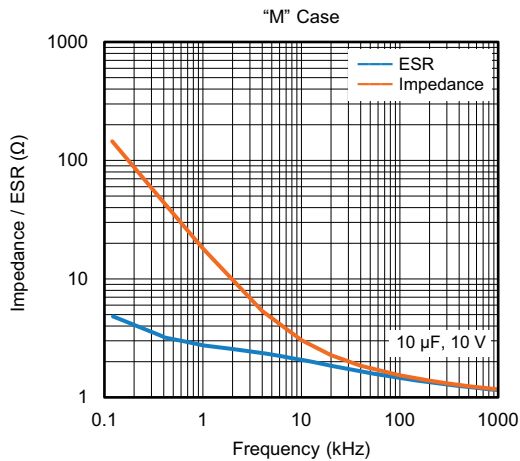
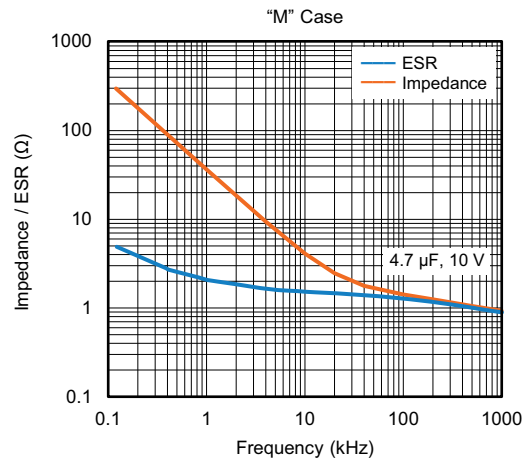
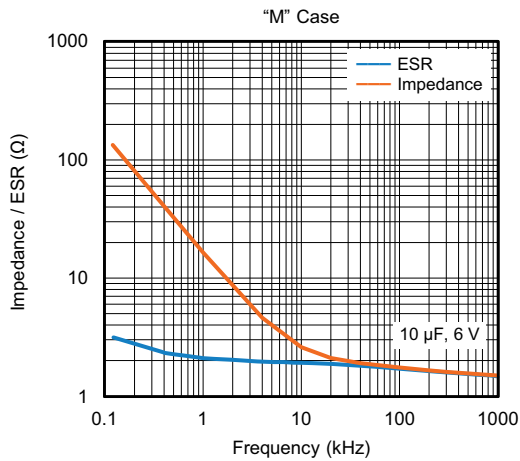
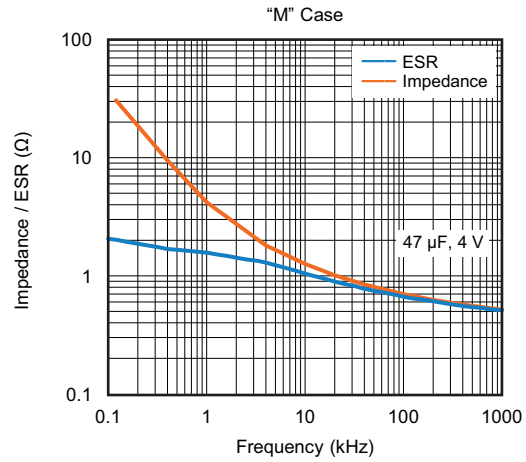
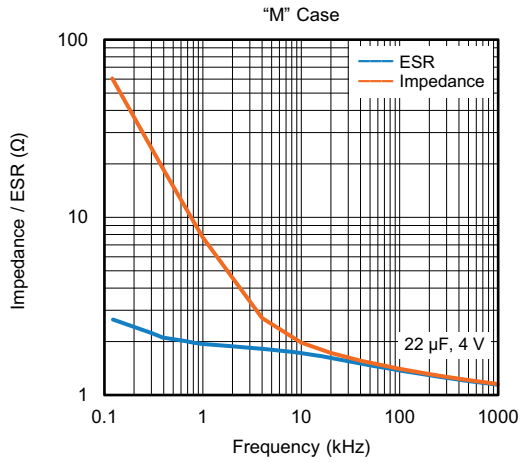



TYPICAL CURVES AT +25 °C, IMPEDANCE AND ESR VS. FREQUENCY

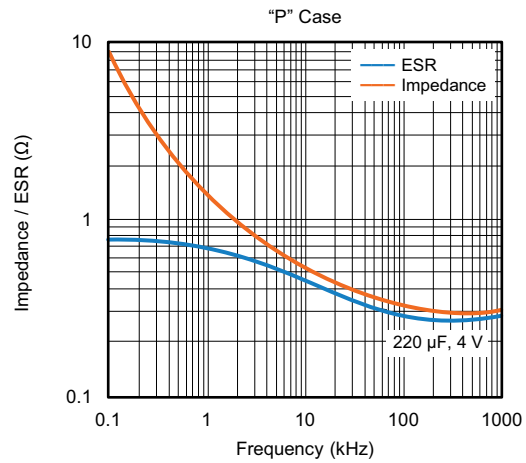
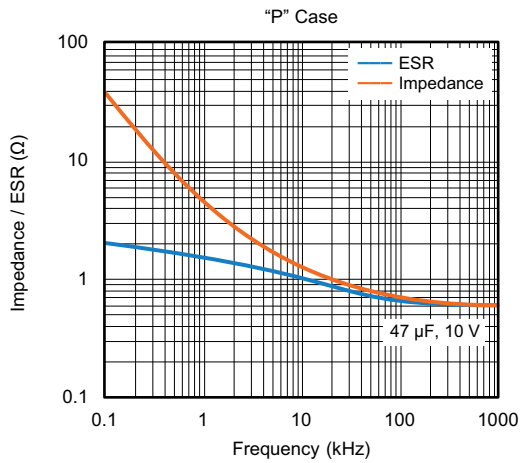
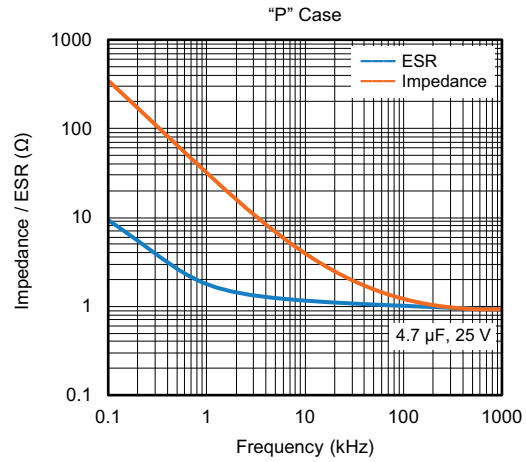
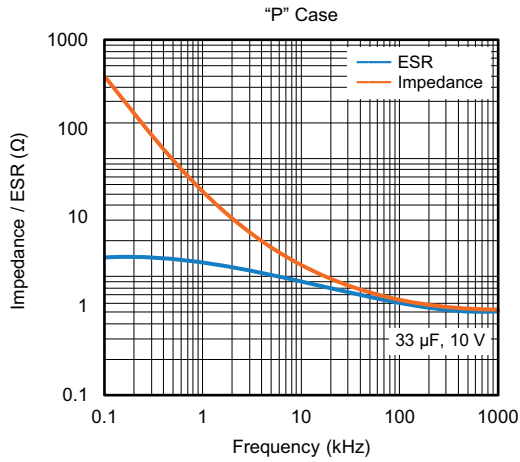



GUIDE TO APPLICATION

- 1. **AC Ripple Current:** the maximum allowable ripple current shall be determined from the formula:

$$I_{RMS} = \sqrt{\frac{P}{R_{ESR}}}$$

where,

P = power dissipation in watts at +25 °C (see paragraph number 5 and the table Power Dissipation as given in the tables in the product datasheets)

R_{ESR} = the capacitor equivalent series resistance at the specified frequency

- 2. **AC Ripple Voltage:** the maximum allowable ripple voltage shall be determined from the formula:

$$V_{RMS} = Z \sqrt{\frac{P}{R_{ESR}}}$$

or, from the formula:

$$V_{RMS} = I_{RMS} \times Z$$

where,

P = power dissipation in watts at +25 °C (see paragraph number 5 and the table Power Dissipation as given in the tables in the product datasheets)

R_{ESR} = the capacitor equivalent series resistance at the specified frequency

Z = the capacitor impedance at the specified frequency

- 2.1 The sum of the peak AC voltage plus the applied DC voltage shall not exceed the DC voltage rating of the capacitor.
- 2.2 The sum of the negative peak AC voltage plus the applied DC voltage shall not allow a voltage reversal exceeding 10 % of the DC working voltage at +25 °C.
- 3. **Reverse Voltage:** these capacitors are capable of withstanding peak voltages in the reverse direction equal to 10 % of the DC rating at +25 °C, 5 % of the DC rating at +85 °C, and 1 % of the DC rating at +125 °C.
- 4. **Temperature Derating:** if these capacitors are to be operated at temperatures above +25 °C, the permissible RMS ripple current shall be calculated using the derating factors as shown:

TEMPERATURE	DERATING FACTOR
+25 °C	1.0
+85 °C	0.9
+125 °C	0.4

- 5. **Power Dissipation:** power dissipation will be affected by the heat sinking capability of the mounting surface. Non-sinusoidal ripple current may produce heating effects which differ from those shown. It is important that the equivalent I_{RMS} value be established when calculating permissible operating levels. (Power Dissipation calculated using +25 °C temperature rise.)

- 6. **Printed Circuit Board Materials:** molded capacitors are compatible with commonly used printed circuit board materials (alumina substrates, FR4, FR5, G10, PTFE-fluorocarbon and porcelainized steel).

- 7. **Attachment:**

- 7.1 **Solder Paste:** the recommended thickness of the solder paste after application is 0.007" ± 0.001" [0.178 mm ± 0.025 mm]. Care should be exercised in selecting the solder paste. The metal purity should be as high as practical. The flux (in the paste) must be active enough to remove the oxides formed on the metallization prior to the exposure to soldering heat. In practice this can be aided by extending the solder preheat time at temperatures below the liquidous state of the solder.

- 7.2 **Soldering:** capacitors can be attached by conventional soldering techniques; vapor phase, convection reflow, infrared reflow, wave soldering and hot plate methods. The Soldering Profile charts show recommended time / temperature conditions for soldering. Preheating is recommended. The recommended maximum ramp rate is 3 °C per second. Attachment with a soldering iron is not recommended due to the difficulty of controlling temperature and time at temperature. The soldering iron must never come in contact with the capacitor. For details see www.vishay.com/doc?40214.

- 7.2.1 **Backward and Forward Compatibility:** capacitors with SnPb or 100 % tin termination finishes can be soldered using SnPb or lead (Pb)-free soldering processes.

- 8. **Cleaning (Flux Removal) After Soldering:** molded capacitors are compatible with all commonly used solvents such as TES, TMS, Prelete, Chlorethane, Terpene and aqueous cleaning media. However, CFC / ODS products are not used in the production of these devices and are not recommended. Solvents containing methylene chloride or other epoxy solvents should be avoided since these will attack the epoxy encapsulation material.

- 8.1 When using ultrasonic cleaning, the board may resonate if the output power is too high. This vibration can cause cracking or a decrease in the adherence of the termination. DO NOT EXCEED 9W/l at 40 kHz for 2 min.

- 9. **Recommended Mounting Pad Geometries:** proper mounting pad geometries are essential for successful solder connections. These dimensions are highly process sensitive and should be designed to minimize component rework due to unacceptable solder joints. The dimensional configurations shown are the recommended pad geometries for both wave and reflow soldering techniques. These dimensions are intended to be a starting point for circuit board designers and may be fine tuned if necessary based upon the peculiarities of the soldering process and / or circuit board design.



Solid Tantalum Chip Capacitors MICROTAN[®] Leadframeless Molded Capacitors 298D, 298W, TR8 and TL8

ELECTRICAL PERFORMANCE CHARACTERISTICS			
ITEM	PERFORMANCE CHARACTERISTICS		
Category temperature range	-55 °C to +85 °C (to +125 °C with voltage derating)		
Capacitance tolerance	± 20 %, ± 10 %, tested via bridge method, at 25 °C, 120 Hz		
Dissipation factor	Limits per Standard Ratings table. Tested via bridge method, at 25 °C, 120 Hz.		
ESR	Limits per Standard Ratings table. Tested via bridge method, at 25 °C, 100 kHz.		
Leakage current	After application of rated voltage applied to capacitors for 5 min using a steady source of power with 1 kΩ resistor in series with the capacitor under test, leakage current at 25 °C is not more than described in Standard Ratings table. <i>Note that the leakage current varies with temperature and applied voltage. See graph below for the appropriate adjustment factor.</i>		
Reverse voltage	Capacitors are capable of withstanding peak voltages in the reverse direction equal to: 10 % of the DC rating at +25 °C 5 % of the DC rating at +85 °C 1 % of the DC rating at +125 °C Vishay does not recommend intentional or repetitive application of reverse voltage.		
Ripple current and Temperature derating	For maximum permissible ripple current (I_{RMS}) or/and voltage (V_{RMS}) please refer to product datasheet and Guide to Application. If capacitors are to be used at temperatures above +25 °C, the permissible RMS ripple current or voltage shall be calculated using the derating factors: 1.0 at +25 °C 0.9 at +85 °C 0.4 at +125 °C		
Maximum working (operating) voltage	298W AND TL8		
	RATED VOLTAGE (V) -55 °C to +40 °C	CATEGORY VOLTAGE (V) AT TEMPERATURE RANGE	
		+40 °C to +85 °C	+85 °C to +125 °C
	4.0	2.5	1.6
	6.3	4.0	2.5
	10	6.3	4.0
	16	10	6.3
	20	13	8.0
	25	17	10
	35	23	14
	298D AND TR8		
	RATED VOLTAGE (V) -55 °C to +85 °C	CATEGORY VOLTAGE (V) AT TEMPERATURE RANGE	
		+85 °C to +125 °C	
	2.5	1.7	
4.0	2.7		
6.3	4.0		
10	7.0		
16	10		
20	13		
25	17		
35	23		
50	33		

Notes

- All information presented in this document reflects typical performance characteristics
- For information about recommended voltage derating see technical note: www.vishay.com/doc?40246
- The voltage derating recommended in technical note (taken as ratio between recommended voltage and full rated voltage) should be applied with respect to maximum allowed working (operating) voltage in given temperature range
- For product series 298W and TL8:
 - in the range from -55 °C to +40 °C maximum allowed working (operating) voltage is equal to rated voltage
 - in the ranges +40 °C to +85 °C and +85 °C to +125 °C maximum allowed working (operating) voltages ("category" voltages) are shown in the table above
- For product series 298D and TR8:
 - in the range from -55 °C to +85 °C maximum allowed working (operating) voltage is equal to 100 % of rated voltage
 - at temperature +125 °C maximum allowed working (operating) voltage ("category" voltage) is equal to 2/3 (or 67 %) of full rated voltage
 - in the range +85 °C to 125 °C "category" voltage linearly decreases from 100 % to 67 %



298D / TR8: CATEGORY TO RATED VOLTAGE RATIO VS. OPERATING TEMPERATURE (°C)

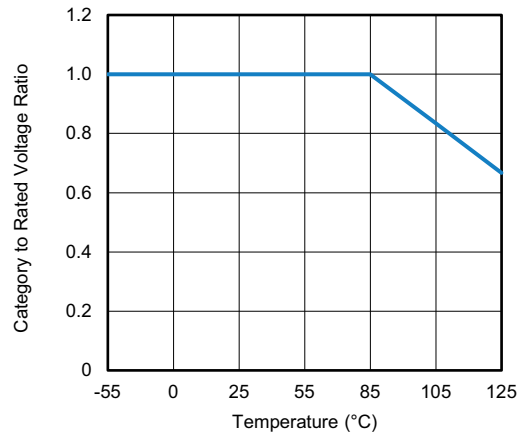

298W / TL8: CATEGORY TO RATED VOLTAGE RATIO VS. OPERATING TEMPERATURE (°C)

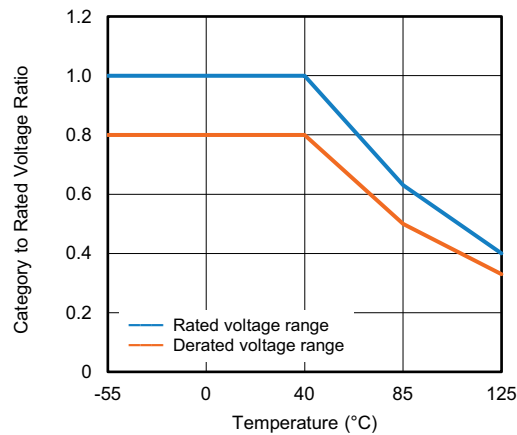

TYPICAL LEAKAGE CURRENT FACTOR RANGE

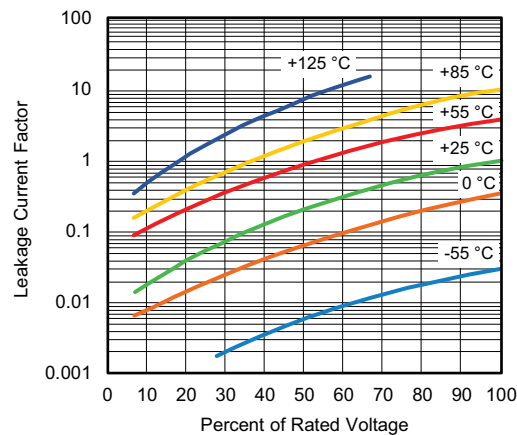

Notes

- At +25 °C, the leakage current shall not exceed the value listed in the Standard Ratings table
- At +85 °C, the leakage current shall not exceed 10 times the value listed in the Standard Ratings table
- At +125 °C, the leakage current shall not exceed 12 times the value listed in the Standard Ratings table



ENVIRONMENTAL PERFORMANCE CHARACTERISTICS		
ITEM	CONDITION	POST TEST PERFORMANCE
Thermal shock	At -55 °C/+125 °C, 30 min each, for 5 cycles. MIL-STD-202 method 107	Capacitance change ± 30 % Dissipation factor Not to exceed 150 % of initial Leakage current Not to exceed 200 % of initial
Surge voltage	85 °C, 1000 successive test cycles at 1.3 of category voltage in series with a 1 kΩ resistor at the rate of 30 s ON, 30 s OFF, MIL-PRF-55365	Capacitance change ± 30 % Dissipation factor Not to exceed 150 % of initial Leakage current Not to exceed 200 % of initial
Life test at +85 °C	1000 h application of category voltage at 85 °C with a 3 Ω series resistance, MIL-STD-202 method 108	Capacitance change ± 30 % Dissipation factor Not to exceed 150 % of initial Leakage current Not to exceed 200 % of initial
Humidity test	At 40 °C/90 % RH 500 h, no voltage applied. MIL-STD-202 method 103	Capacitance change ± 30 % Dissipation factor Not to exceed 150 % of initial Leakage current Not to exceed 200 % of initial

MECHANICAL PERFORMANCE CHARACTERISTICS		
ITEM	CONDITION	POST TEST PERFORMANCE
Terminal strength/ Shear stress test	Apply a pressure load of 5 N for 10 s ± 1 s horizontally to the center of capacitor side body. AEC-Q200-006	There shall be no visual damage when viewed at 20 x magnification and the component shall meet the original electrical requirements.
Vibration	MIL-STD-202, method 204, condition D, 10 Hz to 2000 Hz, 20 g peak	There shall be no mechanical or visual damage to capacitors post-conditioning.
Shock (specified pulse)	MIL-STD-202, method 213, condition I, 100 g peak	Capacitance change ± 30 % Dissipation factor Initial specified value or less Leakage current Initial specified value or less There shall be no mechanical or visual damage to capacitors post-conditioning.
Resistance to solder heat	MIL-STD-202, method 210, condition K	Capacitance change ± 30 % Dissipation factor Not to exceed 150 % of initial Leakage current Not to exceed 200 % of initial There shall be no mechanical or visual damage to capacitors post-conditioning.
Solderability	MIL-STD-202, method 208, ANSI/J-STD-002, test B. Applies only to solder and tin plated terminations. Does not apply to gold terminations.	All terminations shall exhibit a continuous solder coating free from defects for a minimum of 95 % of the critical area of any individual lead.
Resistance to solvents	MIL-STD-202, method 215	Marking has to remain legible, no degradation of encapsulation material.
Flammability	Encapsulation materials meet UL 94 V-0 with an oxygen index of 32 %	

Note

- All measurements to be performed after 24 h conditioning at room temperature.



Disclaimer

ALL PRODUCT, PRODUCT SPECIFICATIONS AND DATA ARE SUBJECT TO CHANGE WITHOUT NOTICE TO IMPROVE RELIABILITY, FUNCTION OR DESIGN OR OTHERWISE.

Vishay Intertechnology, Inc., its affiliates, agents, and employees, and all persons acting on its or their behalf (collectively, "Vishay"), disclaim any and all liability for any errors, inaccuracies or incompleteness contained in any datasheet or in any other disclosure relating to any product.

Vishay makes no warranty, representation or guarantee regarding the suitability of the products for any particular purpose or the continuing production of any product. To the maximum extent permitted by applicable law, Vishay disclaims (i) any and all liability arising out of the application or use of any product, (ii) any and all liability, including without limitation special, consequential or incidental damages, and (iii) any and all implied warranties, including warranties of fitness for particular purpose, non-infringement and merchantability.

Statements regarding the suitability of products for certain types of applications are based on Vishay's knowledge of typical requirements that are often placed on Vishay products in generic applications. Such statements are not binding statements about the suitability of products for a particular application. It is the customer's responsibility to validate that a particular product with the properties described in the product specification is suitable for use in a particular application. Parameters provided in datasheets and / or specifications may vary in different applications and performance may vary over time. All operating parameters, including typical parameters, must be validated for each customer application by the customer's technical experts. Product specifications do not expand or otherwise modify Vishay's terms and conditions of purchase, including but not limited to the warranty expressed therein.

Hyperlinks included in this datasheet may direct users to third-party websites. These links are provided as a convenience and for informational purposes only. Inclusion of these hyperlinks does not constitute an endorsement or an approval by Vishay of any of the products, services or opinions of the corporation, organization or individual associated with the third-party website. Vishay disclaims any and all liability and bears no responsibility for the accuracy, legality or content of the third-party website or for that of subsequent links.

Except as expressly indicated in writing, Vishay products are not designed for use in medical, life-saving, or life-sustaining applications or for any other application in which the failure of the Vishay product could result in personal injury or death. Customers using or selling Vishay products not expressly indicated for use in such applications do so at their own risk. Please contact authorized Vishay personnel to obtain written terms and conditions regarding products designed for such applications.

No license, express or implied, by estoppel or otherwise, to any intellectual property rights is granted by this document or by any conduct of Vishay. Product names and markings noted herein may be trademarks of their respective owners.