



Designers' Choice

# NEW PRODUCT BULLETIN

## New COLOR CODED SCREW TERMINALS



### Color Coded Screw Terminals provide:

- Quick identification
- Visibility for field service troubleshooting

### SPECIFICATIONS

**Combination Binding Head:**  
Standard screw is Brass, Nickel Plate. For painted, color head, add suffix as shown.



**COLOR SELECTION:**  
Select desired screw terminal and add color suffix to the screw terminal Cat. No.

HEAD COLOR	SUFFIX
RED	-2
BLACK	-3
WHITE	-4
BLUE	-5
GREEN	-6
YELLOW	-7
NICKEL	none

**CAT. NO. COLOR SUFFIX**  
Ex: XXXX -X



• Available for screw terminals where noted.

## LOW PROFILE - PC SCREW TERMINALS

These easy to mount screw terminals are ideally suited for high density packaging and are available unassembled or with the screw installed and captivated. They are a practical alternative to PC screw type edge connectors, barrier blocks, terminal boards and terminal strips.

### PRINCIPAL FEATURES

- Low profile
- Stable, no-rock design
- Easily mounts in pre-drilled or stamped holes
- Accepts 12-22 AWG solid or stranded wire, crimp type terminals or lugs
- Space saving and time saving
- Combination drive, binding head screw



**New** Color coded screws available (add color screw suffix to Cat. No.)

### SPECIFICATIONS

**Rated:** 15 Amps  
**Terminal:**  
.032 Brass, Tin Plate  
**Binding Head Screw:**  
Brass, Nickel Plate

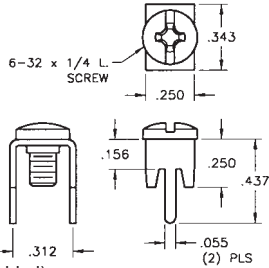

Mounting Detail

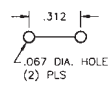

**CAT. NO. 7784**  
(Supplied Less Screw)  
**CAT. NO. 8198**  
(Screw Supplied Unassembled)  
**CAT. NO. 7778**  
(Screw Installed & Captivated)

A practical, low-cost alternative to PC screw type edge connectors, barrier blocks, terminal boards and terminal strips. Supplied unassembled or with screw installed and captivated.

### PRINCIPAL FEATURES

- Low profile
  - Stable, no-rock design with exclusive anti-rotational feature
  - Ideally suited for high-density packaging
  - Space saving and time saving
  - Combination drive, binding head screw
- New** Color coded screws available (add color screw suffix to Cat. No.)



### SPECIFICATIONS

**Rated:** 15 Amps  
**Terminal:**  
.032 Brass, Tin Plate  
**Binding Head Screw:**  
Brass, Nickel Plate

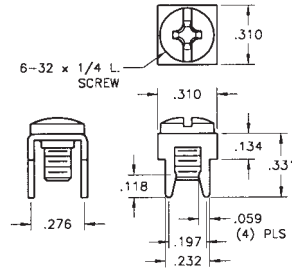

Mounting Detail

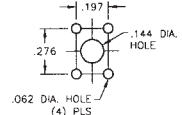

**CAT. NO. 7785**  
(Supplied Less Screw)  
**CAT. NO. 8195**  
(Screw Supplied Unassembled)  
**CAT. NO. 7775**  
(Screw Installed & Captivated)

## 30 AMP - PC SCREW TERMINALS

A practical, low-cost alternative to PC screw type edge connectors, barrier blocks, terminal boards and terminal strips. Supplied unassembled or with screw installed and captivated.

### PRINCIPAL FEATURES

- Compact, heavy duty design
  - Six snap-in legs for total stability
  - Serrated top surface secures connection
  - Combination drive, binding head screw
- New** Color coded screws available (add color screw suffix to Cat. No.)



### SPECIFICATIONS

**Rated:** 30 Amps  
**Terminal:**  
.032 Brass, Tin Plate  
**Binding Head Screw:**  
Brass, Nickel Plate

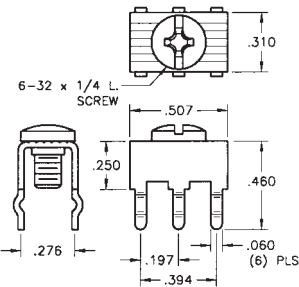

Mounting Detail

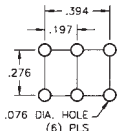

**CAT. NO. 7786**  
(Supplied Less Screw)  
**CAT. NO. 8197**  
(Screw Supplied Unassembled)  
**CAT. NO. 8199**  
(Screw Installed & Captivated)

### HEAVY DUTY

This heavy duty screw terminal has been designed to carry 30 Amps, while maintaining a space saving compact profile, making it ideal for high density packaging.

### PRINCIPAL FEATURES

- Compact, heavy duty design
- Six snap-in legs for total stability
- Serrated top surface secures connection



### SPECIFICATIONS

**Rated:** 30 Amps  
**Terminal:**  
.045 Brass, Tin Plate  
**Screw:** Stainless Steel

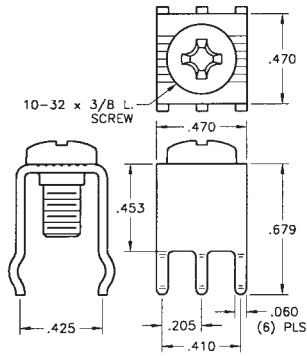

Mounting Detail

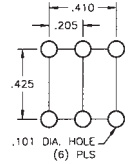

**CAT. NO. 7787**  
(Supplied Less Screw)  
**CAT. NO. 8196**  
(Screw Supplied Unassembled)

## PC MOUNT SCREW TERMINALS

These easy-to-mount, multipurpose screw type terminals are a practical, low-cost alternative to PC screw type edge connectors, barrier blocks, terminal boards and terminal strips. Steadfast and easy to install, will accommodate solid or stranded wire, crimp type terminals or lugs. Multi-placement of these low-profile terminals make them ideally suited for high density packaging. Supplied unassembled or with screw installed and captivated.

### PRINCIPAL FEATURES

- Low profile
- Stable, no-rock design with exclusive anti-rotational feature
- Easily mounts with four legs into pre-drilled or punched holes
- Accepts 14-22 AWG solid or stranded wire, crimp type terminals or lugs
- Ideally suited for high-density packaging
- Available in horizontal or vertical mounting
- Space-saving and time saving
- Easy accessibility for PC board testing
- Binding screw is positioned above board level to avoid wicking during wave soldering
- Terminals are made of Brass with Tin Plate
- Supplied with a combination drive 6-32 binding head screw

**New** Color coded screws available (add color screw suffix to Cat. No.)

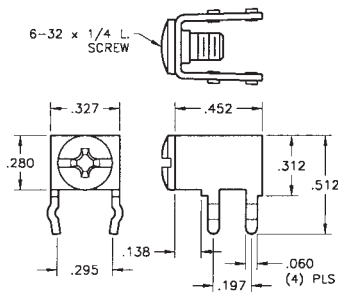
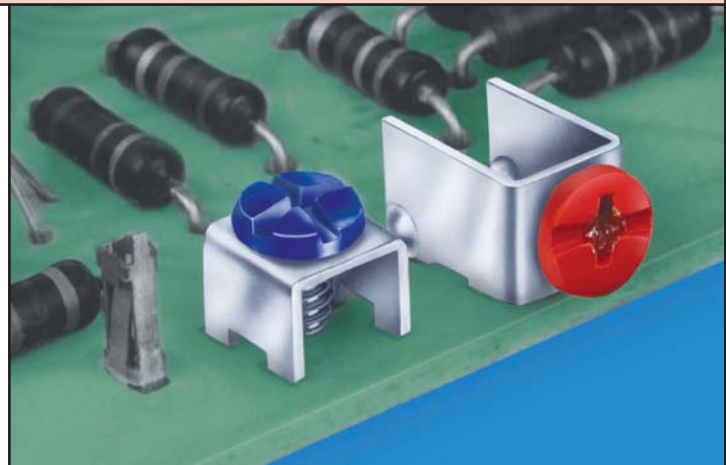

### HORIZONTAL TYPE

#### SPECIFICATIONS

**Rated:** 15 Amps

**Terminal:**

.032 Thick Brass, Tin Plate

**Binding Head Screw:**

Brass, Nickel Plate

Mounting Detail

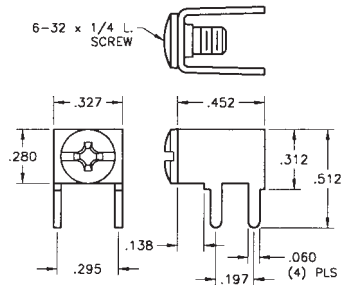

**CAT. NO. 7779** (Supplied Less Screw)  
**CAT. NO. 7690** (Screw Supplied Unassembled)  
**CAT. NO. 7692** (Screw Installed & Captivated)

**New** Color coded screws available (add color screw suffix to Cat. No.)

**CAT. NO. 7781** (Supplied Less Screw)  
**CAT. NO. 8190** (Screw Supplied Unassembled)  
**CAT. NO. 7700** (Screw Installed & Captivated)

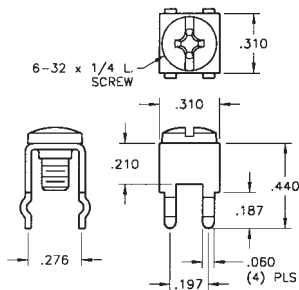

### VERTICAL TYPE

#### SPECIFICATIONS

**Rated:** 15 Amps

**Terminal:**

.032 Thick Brass, Tin Plate

**Binding Head Screw:**

Brass, Nickel Plate

Mounting Detail

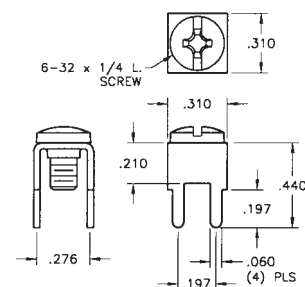

**CAT. NO. 7780** (Supplied Less Screw)  
**CAT. NO. 7691** (Screw Supplied Unassembled)  
**CAT. NO. 7693** (Screw Installed & Captivated)

**New** Color coded screws available (add color screw suffix to Cat. No.)

**CAT. NO. 7782** (Supplied Less Screw)  
**CAT. NO. 8191** (Screw Supplied Unassembled)  
**CAT. NO. 7701** (Screw Installed & Captivated)

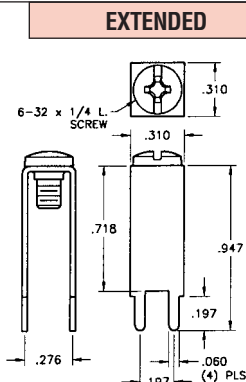

### EXTENDED

#### SPECIFICATIONS

**Rated:** 15 Amps

**Terminal:**

.032 Thick Brass, Tin Plate

**Binding Head Screw:**

Brass, Nickel Plate

Mounting Detail

### 45°

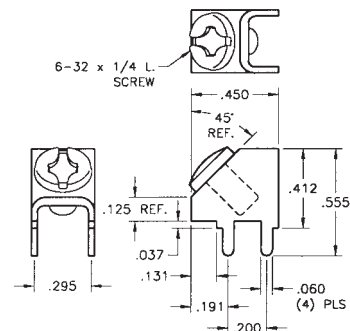

**CAT. NO. 7789** (Supplied Less Screw)  
**CAT. NO. 7697** (Screw Supplied Unassembled)  
**CAT. NO. 7699** (Screw Installed & Captivated)

**New** Color coded screws available (add color screw suffix to Cat. No.)

**CAT. NO. 7783** (Supplied Less Screw)  
**CAT. NO. 8189** (Screw Supplied Unassembled)  
**CAT. NO. 7702** (Screw Installed & Captivated)