

Type CPF Series

Key Features

Thin film precision resistors with TC's to 15ppm and tolerances to 0.05%.

Wide range of case sizes from 0201 to 2512

Suitable for all applications where close accuracy and stability are essential

Terminal finish – electroplated 100% matte Sn



Applications

Communications

Industrial Controls

Instrumentation

Medical

The CPF series is a high stability precision chip resistor range offering various power dissipations relating to a wide range of chip sizes. The CPF series offers TCR's down to 15ppm/°C and resistance tolerances to 0.1%. Standard values are within the IEC 63 E96 and E24 value grids. The CPF has accurate and uniform physical dimensions to facilitate placement

Electrical Characteristics

| | | | | | | | |
|--------------------------------|-----------------|------|------|------|------|------|------|
| Chip Size | 0201 | | | | | | |
| Rated Power @70°C | 0.03125W | | | | | | |
| Resistance Range Ω | Min. | 49R9 | 49R9 | 49R9 | 49R9 | 49R9 | 49R9 |
| | Max | 75K | 75K | 75K | 75K | 75K | 75K |
| Tolerance | 0.1 | | 0.5 | | 1 | | |
| Code Letter | B | | D | | F | | |
| Selection series | E24 & E96 | | | | | | |
| Temp. Coefficient (ppm/°C) | 25 | 50 | 25 | 50 | 25 | 50 | |
| Code Letter | E | C | E | C | E | C | |
| Operating Voltage (Max) | 15V | | | | | | |
| Max. Overload Voltage | 30V | | | | | | |
| Operating Temp. Range | -55 ~ +155°C | | | | | | |
| Insulation Resistance dry min. | >1000M Ω | | | | | | |
| Stability | 0.5% | | | | | | |

| | | | | | | | | | | | | |
|---------------------------|-----------------|------|----|-----|------|----|------|----|------|----|------|----|
| Chip Size | 0402 | | | | | | | | | | | |
| Rated Power @70°C | 0.063W | | | | | | | | | | | |
| Resistance Range Ω | Min. | 49R9 | | | 4R02 | | 4R02 | | 49R9 | | 4R02 | |
| | Max | 20K | | | 100K | | 511K | | 100K | | 511K | |
| Tolerance (%) | 0.05 | | | 0.1 | | | 0.5 | | | 1 | | |
| Code Letter | A | | | B | | | D | | | F | | |
| Selection series | E24 & E96 | | | | | | | | | | | |
| T.C.R. (ppm/°C) | 15 | 25 | 50 | 15 | 25 | 50 | 15 | 25 | 50 | 15 | 25 | 50 |
| Code Letter | D | E | C | D | E | C | D | E | C | D | E | C |
| Max Operating Volt. | 25V | | | | | | | | | | | |
| Max. Overload Volt. | 50V | | | | | | | | | | | |
| Op. Temp. Range | -55 ~ +155°C | | | | | | | | | | | |
| Insulation Resistance | >1000M Ω | | | | | | | | | | | |
| Stability | 0.5% | | | | | | | | | | | |

| | | | | | | | | | | | | |
|---------------------------|-----------------|------|----|-----|------|----|-----|----|------|----|-----|----|
| Chip Size | 0603 | | | | | | | | | | | |
| Rated Power @70°C | 0.063W | | | | | | | | | | | |
| Resistance Range Ω | Min. | 4R7 | | | 4R7 | | 1R0 | | 4R7 | | 1R0 | |
| | Max | 332K | | | 511K | | 1M0 | | 511K | | 1M0 | |
| Tolerance (%) | 0.05 | | | 0.1 | | | 0.5 | | | 1 | | |
| Code Letter | A | | | B | | | D | | | F | | |
| Selection series | E24 & E96 | | | | | | | | | | | |
| T.C.R. (ppm/°C) | 15 | 25 | 50 | 15 | 25 | 50 | 15 | 25 | 50 | 15 | 25 | 50 |
| Code Letter | D | E | C | D | E | C | D | E | C | D | E | C |
| Max Operating Volt. | 50V | | | | | | | | | | | |
| Max. Overload Volt. | 100V | | | | | | | | | | | |
| Op. Temp. Range | -55 ~ +155°C | | | | | | | | | | | |
| Insulation Resistance | >1000M Ω | | | | | | | | | | | |
| Stability | 0.5% | | | | | | | | | | | |

| | | | | | | | | | | | | |
|---------------------------|-----------------|-----|----|-----|-----|----|-----|----|-----|----|-----|----|
| Chip Size | 0805 | | | | | | | | | | | |
| Rated Power @70°C | 0.1W | | | | | | | | | | | |
| Resistance Range Ω | Min. | 4R7 | | | 4R7 | | 1R0 | | 4R7 | | 1R0 | |
| | Max | 1M0 | | | 1M0 | | 2M0 | | 1M0 | | 2M0 | |
| Tolerance (%) | 0.05 | | | 0.1 | | | 0.5 | | | 1 | | |
| Code Letter | A | | | B | | | D | | | F | | |
| Selection series | E24 & E96 | | | | | | | | | | | |
| T.C.R. (ppm/°C) | 15 | 25 | 50 | 15 | 25 | 50 | 15 | 25 | 50 | 15 | 25 | 50 |
| Code Letter | D | E | C | D | E | C | D | E | C | D | E | C |
| Max Operating Volt. | 100V | | | | | | | | | | | |
| Max. Overload Volt. | 200V | | | | | | | | | | | |
| Op. Temp. Range | -55 ~ +155°C | | | | | | | | | | | |
| Insulation Resistance | >1000M Ω | | | | | | | | | | | |
| Stability | 0.5% | | | | | | | | | | | |

| | | | | | | | | | | | | |
|---------------------------|-----------------|-----|-----|-----|------|-----|------|-----|------|----|----|----|
| Chip Size | 1206 | | | | | | | | | | | |
| Rated Power @70°C | 0.125W | | | | | | | | | | | |
| Resistance Range Ω | Min. | 4R7 | 4R7 | 4R7 | 1R0 | 4R7 | 1R0 | 4R7 | 1R0 | | | |
| | Max | 1M5 | 1M0 | 1M5 | 2M49 | 1M5 | 2M49 | 1M5 | 2M49 | | | |
| Tolerance (%) | 0.05 | | | 0.1 | | | 0.5 | | | 1 | | |
| Code Letter | A | | | B | | | D | | | F | | |
| Selection series | E24 & E96 | | | | | | | | | | | |
| T.C.R. (ppm/°C) | 15 | 25 | 50 | 15 | 25 | 50 | 15 | 25 | 50 | 15 | 25 | 50 |
| Code Letter | D | E | C | D | E | C | D | E | C | D | E | C |
| Max Operating Volt. | 150V | | | | | | | | | | | |
| Max. Overload Volt. | 300V | | | | | | | | | | | |
| Op. Temp. Range | -55 ~ +155°C | | | | | | | | | | | |
| Insulation Resistance | >1000M Ω | | | | | | | | | | | |
| Stability | 0.5% | | | | | | | | | | | |

| | | | | | | | | | | | | |
|---------------------------|-----------------|-----|-----|------|-----|------|-----|------|----|----|----|----|
| Chip Size | 1210 | | | | | | | | | | | |
| Rated Power @70°C | 0.25W | | | | | | | | | | | |
| Resistance Range Ω | Min. | 4R7 | 4R7 | 1R0 | 4R7 | 1R0 | 4R7 | 1R0 | | | | |
| | Max | 1M0 | 1M0 | 2M49 | 1M0 | 2M49 | 1M0 | 2M49 | | | | |
| Tolerance (%) | 0.05 | | | 0.1 | | | 0.5 | | | 1 | | |
| Code Letter | A | | | B | | | D | | | F | | |
| Selection series | E24 & E96 | | | | | | | | | | | |
| T.C.R. (ppm/°C) | 15 | 25 | 50 | 15 | 25 | 50 | 15 | 25 | 50 | 15 | 25 | 50 |
| Code Letter | D | E | C | D | E | C | D | E | C | D | E | C |
| Max Operating Volt. | 150V | | | | | | | | | | | |
| Max. Overload Volt. | 300V | | | | | | | | | | | |
| Op. Temp. Range | -55 ~ +155°C | | | | | | | | | | | |
| Insulation Resistance | >1000M Ω | | | | | | | | | | | |
| Stability | 0.5% | | | | | | | | | | | |

| | | | | | | | | | | | | |
|---------------------------|-----------------|-----|-----|-----|-----|-----|-----|-----|----|----|----|----|
| Chip Size | 2010 | | | | | | | | | | | |
| Rated Power @70°C | 0.25W | | | | | | | | | | | |
| Resistance Range Ω | Min. | 4R7 | 4R7 | 1R0 | 4R7 | 1R0 | 4R7 | 1R0 | | | | |
| | Max | 1M0 | 1M0 | 3M0 | 1M0 | 3M0 | 1M0 | 3M0 | | | | |
| Tolerance (%) | 0.05 | | | 0.1 | | | 0.5 | | | 1 | | |
| Code Letter | A | | | B | | | D | | | F | | |
| Selection series | E24 & E96 | | | | | | | | | | | |
| T.C.R. (ppm/°C) | 15 | 25 | 50 | 15 | 25 | 50 | 15 | 25 | 50 | 15 | 25 | 50 |
| Code Letter | D | E | C | D | E | C | D | E | C | D | E | C |
| Max Operating Volt. | 150V | | | | | | | | | | | |
| Max. Overload Volt. | 300V | | | | | | | | | | | |
| Op. Temp. Range | -55 ~ +155°C | | | | | | | | | | | |
| Insulation Resistance | >1000M Ω | | | | | | | | | | | |
| Stability | 0.5% | | | | | | | | | | | |

| | | | | | | | | | | | | | | | | |
|-----------------------|--------------|-----|----|-----|-----|----|-----|-----|----|----|-----|----|--|-----|--|--|
| Chip Size | 2512 | | | | | | | | | | | | | | | |
| Rated Power @70°C | 0.5W | | | | | | | | | | | | | | | |
| Resistance Range Ω | Min. | 4R7 | | | 4R7 | | | 1R0 | | | 4R7 | | | 1R0 | | |
| | Max | 1M0 | | | 1M0 | | | 3M0 | | | 1M0 | | | 3M0 | | |
| Tolerance (%) | 0.05 | | | 0.1 | | | 0.5 | | | 1 | | | | | | |
| Code Letter | A | | | B | | | D | | | F | | | | | | |
| Selection series | E24 & E96 | | | | | | | | | | | | | | | |
| T.C.R. (ppm/°C) | 15 | 25 | 50 | 15 | 25 | 50 | 15 | 25 | 50 | 15 | 25 | 50 | | | | |
| Code Letter | D | E | C | D | E | C | D | E | C | D | E | C | | | | |
| Max Operating Volt. | 150V | | | | | | | | | | | | | | | |
| Max. Overload Volt. | 300V | | | | | | | | | | | | | | | |
| Op. Temp. Range | -55 ~ +155°C | | | | | | | | | | | | | | | |
| Insulation Resistance | >1000MΩ | | | | | | | | | | | | | | | |
| Stability | 0.5% | | | | | | | | | | | | | | | |

Environmental Characteristics

| Item | Requirement | | Test Method |
|---|--|-------------|--|
| | Tol. ≤0.05% | TOL. >0.05% | |
| Temperature Coefficient of Resistance (TCR) | As per TCRs specified in Electrical Characteristics tables | | MIL-STD-202 Method 304 +25/-55/+25/+125/+25°C |
| Short Time Overload | ΔR±0.05% | ΔR±0.2% | JIS-C-5201-1 5.5 RCWV*2.5 or Max. overload voltage whichever is lower for 5 seconds |
| Insulation Resistance | >9999 MΩ | | MIL-STD-202 Method 302 Apply 100VDC for 1 minute |
| Endurance | ΔR±0.05% | ΔR±0.2% | MIL-STD-202 Method 108A 70±2°C, RCWV for 1000 hrs with 1.5 hrs "ON" and 0.5 hrs "OFF" |
| | 0201: >7kΩ ΔR±0.5% ≤7kΩ ΔR±0.2% | | |
| Damp Heat with Load | ΔR±0.05% | ΔR±0.3% | MIL-STD-202 Method 103B 40±2°C, 90~95% R.H. RCWV for 1000 hrs with 1.5 hrs "ON" and 0.5 hrs "OFF" |
| Bending Strength | ΔR±0.05% | ΔR±0.1% | JIS-C-5201-1 6.1.4 Bending amplitude 3 mm for 10 seconds |
| Solderability | 95% min. coverage | | MIL-STD-202 Method 208H 245±5°C for 3 seconds |
| Resistance to Soldering Heat | ΔR±0.05% | ΔR±0.1% | MIL-STD-202 Method 210E 260±5°C for 10 seconds |
| Dielectric Withstand Voltage | By Type | | MIL-STD-202 Method 301 Max. overload voltage for 1 minute |
| Thermal Shock | ΔR±0.05% | ΔR±0.2% | MIL-STD-202 Method 107G -55°C ~150°C, 100 cycles |
| Low Temperature Operation | ΔR±0.05% | ΔR±0.2% | JIS-C-5201-1 7.1 1 hour, -65°C, followed by 45 minutes of RCWV |
| High Temperature Exposure | ΔR±0.5% | | MIL-STD-202 Method 107G At +155°C for 1000 hours |

RCWV(Rated continuous working voltage)= $\sqrt{P \cdot R}$ or Max. Operating voltage whichever is lower

Storage Temperature: 25±3°C; Humidity < 80%RH

Derating Curve

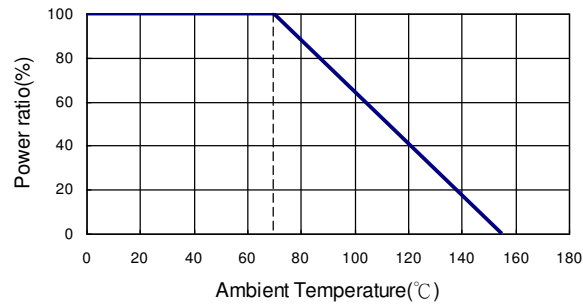

Construction and dimensions

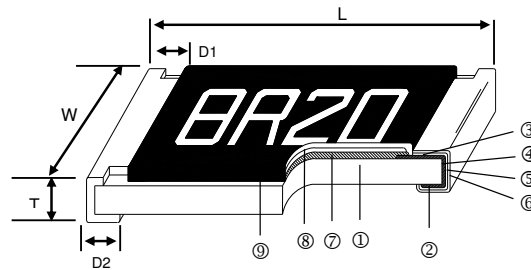

| | | |
|-------------------------|---------------------------|-------------------------|
| ① Alumina Substrate | ④ Edge Electrode (NiCr) | ⑦ Resistor Layer (NiCr) |
| ② Bottom Electrode (Ag) | ⑤ Barrier Layer (Ni) | ⑧ Overcoat (Epoxy) |
| ③ Top Electrode (Ag) | ⑥ External Electrode (Sn) | ⑨ Marking |

| Size | L (mm) | W (mm) | T (mm) | D1 (mm) | D2 (mm) | Weight (g) (1000 Pcs.) |
|------|-----------|-----------|-----------|-----------|-----------|---------------------------|
| 0201 | 0.58±0.05 | 0.29±0.05 | 0.23±0.05 | 0.12±0.05 | 0.15±0.05 | 0.14 |
| 0402 | 1.00±0.05 | 0.50±0.05 | 0.30±0.05 | 0.20±0.10 | 0.20±0.10 | 0.54 |
| 0603 | 1.55±0.10 | 0.80±0.10 | 0.45±0.10 | 0.30±0.20 | 0.30±0.20 | 1.83 |
| 0805 | 2.00±0.15 | 1.25±0.15 | 0.55±0.10 | 0.30±0.20 | 0.40±0.20 | 4.71 |
| 1206 | 3.05±0.15 | 1.55±0.15 | 0.55±0.10 | 0.42±0.20 | 0.35±0.25 | 9.02 |
| 1210 | 3.10±0.15 | 2.40±0.15 | 0.55±0.10 | 0.40±0.20 | 0.55±0.25 | 10 |
| 2010 | 4.90±0.15 | 2.40±0.15 | 0.55±0.10 | 0.60±0.30 | 0.50±0.25 | 23.61 |
| 2512 | 6.30±0.15 | 3.10±0.15 | 0.55±0.10 | 0.60±0.30 | 0.50±0.25 | 38.06 |

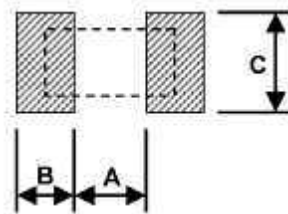

| Size | Recommended Land Pattern | | |
|------|--------------------------|------|----------|
| | A | B | C |
| 0201 | 0.25 | 0.30 | 0.40±0.2 |
| 0402 | 0.50 | 0.50 | 0.60±0.2 |
| 0603 | 0.80 | 1.00 | 0.90±0.2 |
| 0805 | 1.00 | 1.00 | 1.35±0.2 |
| 1206 | 2.00 | 1.15 | 1.70±0.2 |
| 1210 | 2.00 | 1.15 | 2.50±0.2 |
| 2010 | 3.60 | 1.40 | 2.50±0.2 |
| 2512 | 4.90 | 1.60 | 3.10±0.2 |

Marking

Case sizes 0805 to 2512 IEC 4 Digit Marking:

| | | | | | |
|------------|-------------|-------------|------------|--------------|--------------|
| Resistance | 100R (100Ω) | 2K2 (2.2kΩ) | 10K (10kΩ) | 499K (499kΩ) | 100K (100kΩ) |
| Code | 1000 | 2201 | 1002 | 4992 | 1003 |

Case Size 0603 E24 3 digit marking – Example 101 = 100R 102=1K0

| | | | | | | | | | | | | |
|-----|----|----|----|----|----|----|----|----|----|----|----|----|
| E24 | 10 | 11 | 12 | 13 | 15 | 16 | 18 | 20 | 22 | 24 | 27 | 30 |
| | 33 | 36 | 39 | 43 | 47 | 51 | 56 | 62 | 68 | 75 | 82 | 91 |

Case size 0603 E96 3 digit marking – Examples 14C = 13K7 68B = 4K99 68X = 49R9

| Code | E96 | Code | E96 | Code | E96 | Code | E96 |
|------|-----|------|-----|------|-----|------|-----|
| 01 | 100 | 25 | 178 | 49 | 316 | 73 | 562 |
| 02 | 102 | 26 | 182 | 50 | 324 | 74 | 576 |
| 03 | 105 | 27 | 187 | 51 | 332 | 75 | 590 |
| 04 | 107 | 28 | 191 | 52 | 340 | 76 | 604 |
| 05 | 110 | 29 | 196 | 53 | 348 | 77 | 619 |
| 06 | 113 | 30 | 200 | 54 | 357 | 78 | 634 |
| 07 | 115 | 31 | 205 | 55 | 365 | 79 | 649 |
| 08 | 118 | 32 | 210 | 56 | 374 | 80 | 665 |
| 09 | 121 | 33 | 215 | 57 | 383 | 81 | 681 |
| 10 | 124 | 34 | 221 | 58 | 392 | 82 | 698 |
| 11 | 127 | 35 | 226 | 59 | 402 | 83 | 715 |
| 12 | 130 | 36 | 232 | 60 | 412 | 84 | 732 |
| 13 | 133 | 37 | 237 | 61 | 422 | 85 | 750 |
| 14 | 137 | 38 | 243 | 62 | 432 | 86 | 768 |
| 15 | 140 | 39 | 249 | 63 | 442 | 87 | 787 |
| 16 | 143 | 40 | 255 | 64 | 453 | 88 | 806 |
| 17 | 147 | 41 | 261 | 65 | 464 | 89 | 825 |
| 18 | 150 | 42 | 267 | 66 | 475 | 90 | 845 |
| 19 | 154 | 43 | 274 | 67 | 487 | 91 | 866 |
| 20 | 158 | 44 | 280 | 68 | 499 | 92 | 887 |
| 21 | 162 | 45 | 287 | 69 | 511 | 93 | 909 |
| 22 | 165 | 46 | 294 | 70 | 523 | 94 | 931 |
| 23 | 169 | 47 | 301 | 71 | 536 | 95 | 953 |
| 24 | 174 | 48 | 309 | 72 | 549 | 96 | 976 |

| Code | A | B | C | D | E | F | G | H | X | Y | Z |
|------------|-----------------|-----------------|-----------------|-----------------|-----------------|-----------------|-----------------|-----------------|------------------|------------------|------------------|
| Multiplier | 10 ⁰ | 10 ¹ | 10 ² | 10 ³ | 10 ⁴ | 10 ⁵ | 10 ⁶ | 10 ⁷ | 10 ⁻¹ | 10 ⁻² | 10 ⁻³ |

NB For case size 0603 values other than E24 and E96 resistors will be supplied unmarked.

All resistors smaller than 0603 supplied unmarked.

Packaging

Packing Quantity and Reel Specification

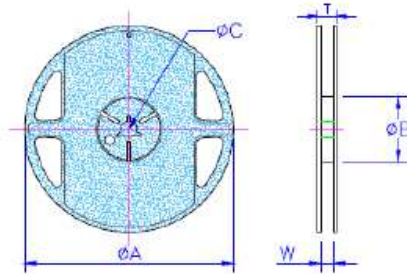

| Size | $\varnothing A \pm 1.0$ | $\varnothing B \pm 1.0$ | $\varnothing C \pm 0.7$ | $W \pm 1.0$ | $T \pm 1.0$ | Paper Tape | Embossed Plastic Tape |
|------|-------------------------|-------------------------|-------------------------|-------------|-------------|--------------|-----------------------|
| 0201 | 178.0 | 60.0 | 13.5 | 9.5 | 11.5 | 1000 / 10000 | N/A |
| 0402 | | | | | | | |
| 0603 | | | | | | | |
| 0805 | | | | 13.5 | 15.5 | 1000 / 5000 | |
| 1206 | | | | | | | |
| 1210 | | | | | | | |
| 2010 | N/A | 4000 | | | | | |
| 2512 | | | | | | | |

Paper tape Specification

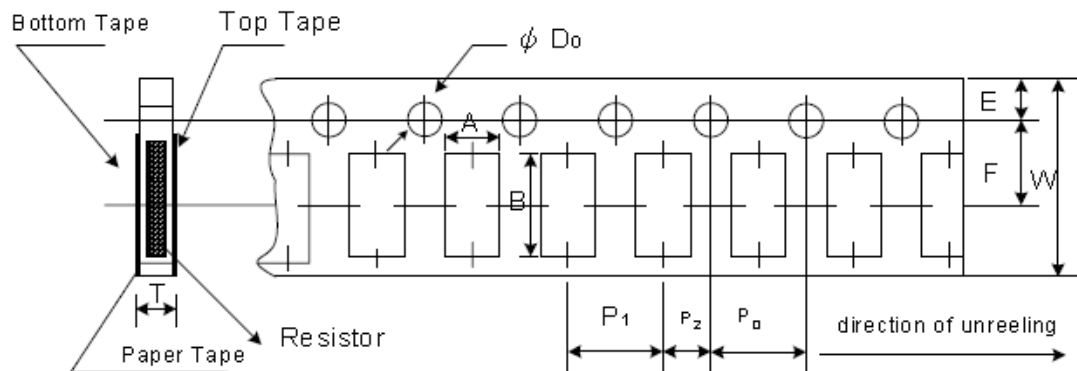

| Size | $A \pm 0.05$ | $B \pm 0.05$ | $W \pm 0.10$ | $E \pm 0.05$ | $F \pm 0.05$ | P_0 | P_1 | $P_2 \pm 0.05$ | $\varnothing D_0$ | T |
|------|--------------|--------------|--------------|--------------|--------------|-----------------|-----------------|----------------|-------------------|-----------------|
| 0201 | 0.40 | 0.70 | 8.00 | 1.75 | 3.5 | 4.00 ± 0.10 | 2.00 ± 0.05 | 2.00 | 1.55 ± 0.03 | 0.42 ± 0.02 |
| 0402 | 0.70 | 1.16 | | | | | 4.00 ± 0.10 | | 1.55 ± 0.05 | 0.40 ± 0.03 |
| 0603 | 1.10 | 1.90 | | | | | 4.00 ± 0.10 | | 1.55 ± 0.05 | 0.60 ± 0.03 |
| 0805 | 1.60 | 2.37 | | | | 4.00 ± 0.05 | 1.60 ± 0.10 | | 0.75 ± 0.05 | |
| 1206 | 2.00 | 3.55 | | | | | | | | |
| 1210 | 2.75 | 3.40 | | | | | | | | |

Peel force of top cover tape

The peel speed shall be about 300mm/min±5%

The peel force of top cover tape shall be between 8gf to 60gf



Embossed Plastic Tape Specifications



| Type | A | B | W | E | F | P ₀ | P ₁ | P ₂ | ØD ₀ | T |
|------|-----------|-----------|-----------|-----------|----------|----------------|----------------|----------------|-----------------|-----------|
| 2010 | 2.85±0.10 | 5.45±0.10 | 12.0±0.10 | 1.75±0.10 | 5.5±0.05 | 4.00±0.05 | 4.00±0.10 | 2.00±0.05 | 1.50±0.10 | 1.00±0.20 |
| 2512 | 3.40±0.10 | 6.65±0.10 | 12.0±0.10 | 1.75±0.10 | 5.5±0.05 | 4.00±0.05 | 4.00±0.10 | 2.00±0.05 | 1.50±0.10 | 1.00±0.20 |

Peel force of top cover tape

The peel speed shall be about 300mm/min±5%

The peel force of top cover tape shall be between 20gf to 80g

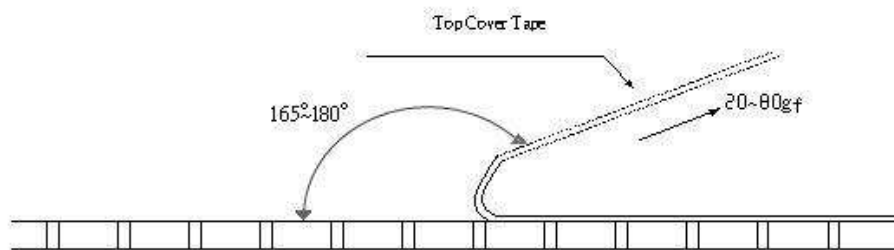

Reflow Solder Profile

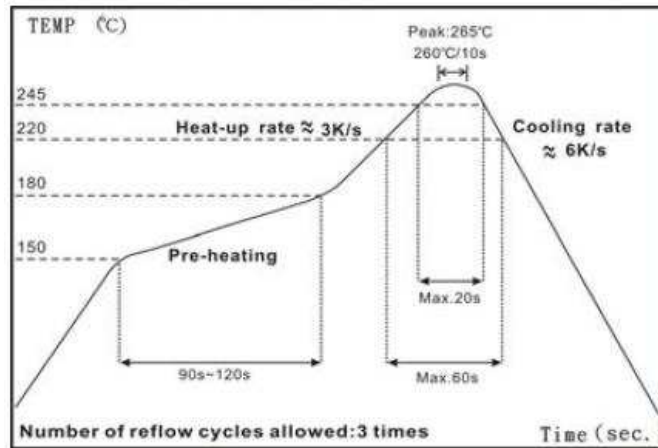

Time of Reflow soldering at maximum temperature point 260°C = 10s

Wave Solder Profile

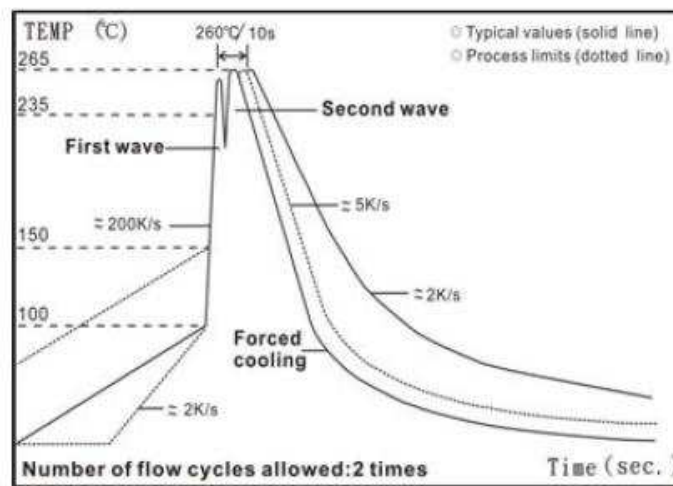

Time of Wave soldering at maximum temperature point 260°C = 10s

Time of Soldering Iron at maximum temperature point 410°C = 5s

How To Order

| CPF | 0603 | B | 100R | E | 1 |
|---|--|-----------------------------------|---|-------------------------------------|---|
| Common Part | Package Size | Tolerance | Value | TCR | Packaging |
| CPF - precision thin film chip resistor | 0201 1206 0402 1210 0603 2010 0805 2512 | B - ±0.1% D - ±0.5% F - ±1% | 100R - 100Ω 1K0 - 1000Ω 10K - 10,000Ω | D - 15PPM E - 25PPM C - 50PPM | 1 - 1K REEL Blank - standard reel 0201 - 10K 0402 0603 0805 1206 1210 - 5K 2010 2512 - 4K |

Mouser Electronics

Authorized Distributor

Click to View Pricing, Inventory, Delivery & Lifecycle Information:

[TE Connectivity:](#)

[CPF0402B4R53E1](#)