



Is Now Part of



ON Semiconductor®

To learn more about ON Semiconductor, please visit our website at
www.onsemi.com

Please note: As part of the Fairchild Semiconductor integration, some of the Fairchild orderable part numbers will need to change in order to meet ON Semiconductor's system requirements. Since the ON Semiconductor product management systems do not have the ability to manage part nomenclature that utilizes an underscore (_), the underscore (_) in the Fairchild part numbers will be changed to a dash (-). This document may contain device numbers with an underscore (_). Please check the ON Semiconductor website to verify the updated device numbers. The most current and up-to-date ordering information can be found at www.onsemi.com. Please email any questions regarding the system integration to Fairchild_questions@onsemi.com.

ON Semiconductor and the ON Semiconductor logo are trademarks of Semiconductor Components Industries, LLC dba ON Semiconductor or its subsidiaries in the United States and/or other countries. ON Semiconductor owns the rights to a number of patents, trademarks, copyrights, trade secrets, and other intellectual property. A listing of ON Semiconductor's product/patent coverage may be accessed at www.onsemi.com/site/pdf/Patent-Marking.pdf. ON Semiconductor reserves the right to make changes without further notice to any products herein. ON Semiconductor makes no warranty, representation or guarantee regarding the suitability of its products for any particular purpose, nor does ON Semiconductor assume any liability arising out of the application or use of any product or circuit, and specifically disclaims any and all liability, including without limitation special, consequential or incidental damages. Buyer is responsible for its products and applications using ON Semiconductor products, including compliance with all laws, regulations and safety requirements or standards, regardless of any support or applications information provided by ON Semiconductor. "Typical" parameters which may be provided in ON Semiconductor data sheets and/or specifications can and do vary in different applications and actual performance may vary over time. All operating parameters, including "Typicals" must be validated for each customer application by customer's technical experts. ON Semiconductor does not convey any license under its patent rights nor the rights of others. ON Semiconductor products are not designed, intended, or authorized for use as a critical component in life support systems or any FDA Class 3 medical devices or medical devices with a same or similar classification in a foreign jurisdiction or any devices intended for implantation in the human body. Should Buyer purchase or use ON Semiconductor products for any such unintended or unauthorized application, Buyer shall indemnify and hold ON Semiconductor and its officers, employees, subsidiaries, affiliates, and distributors harmless against all claims, costs, damages, and expenses, and reasonable attorney fees arising out of, directly or indirectly, any claim of personal injury or death associated with such unintended or unauthorized use, even if such claim alleges that ON Semiconductor was negligent regarding the design or manufacture of the part. ON Semiconductor is an Equal Opportunity/Affirmative Action Employer. This literature is subject to all applicable copyright laws and is not for resale in any manner.



FODM8071

3.3V/5V Logic Gate Output Optocoupler with High Noise Immunity

Features

- High-noise Immunity Characterized by Common Mode Rejection
 - 20 kV/μs Minimum Common Mode Rejection
- High Speed
 - 20 Mbit/s Data Rate (NRZ)
 - 55 ns Maximum Propagation Delay
 - 20 ns Maximum Pulse Width Distortion
 - 30 ns Maximum Propagation Delay Skew
- 3.3 V and 5 V CMOS Compatibility
- Specifications Guaranteed Over 3 V to 5.5 V Supply Voltage and -40°C to +110°C Temperature Range
- Safety and Regulatory Approvals:
 - UL1577, 3750 VAC_{RMS} for 1 Minute
 - DIN EN/IEC60747-5-5

Applications

- Microprocessor System Interface:
 - SPI, I²C
- Industrial Fieldbus Communications:
 - DeviceNet, CAN, RS485
- Programmable Logic Control
- Isolated Data Acquisition System
- Voltage Level Translator

Description

The FODM8071 is a 3.3V/5V high-speed logic gate output optocoupler, which supports isolated communications allowing digital signals to communicate between systems without conducting ground loops or hazardous voltages. It utilizes Fairchild's patented coplanar packaging technology, Optoplanar[®], and optimized IC design to achieve high-immunity, characterized by high common mode rejection specifications.

This high-speed logic gate output optocoupler, housed in a compact 5-pin Mini-Flat package, consists of a high-speed AlGaAs LED at the input coupled to a CMOS detector IC at the output. The detector IC comprises an integrated photodiode, a high-speed transimpedance amplifier and a voltage comparator with an output driver. The CMOS technology coupled with a high-efficiency LED achieves low power consumption as well as very high speed (55 ns propagation delay, 20 ns pulse width distortion).

Related Resources

- [FOD8001 Product Folder](#)
- [FOD0721 Product Folder](#)

Schematic and Package Outline

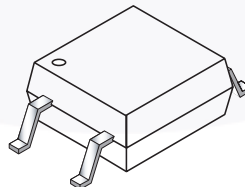
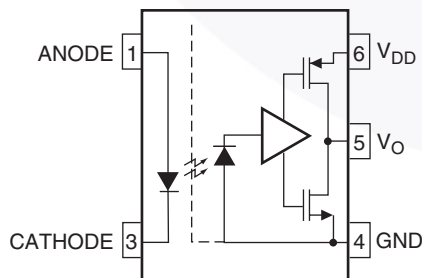

Truth Table

LED	Output
Off	High
On	Low

Figure 1. Schematic and Package Outline

Safety and Insulation Ratings

As per DIN EN/IEC 60747-5-5, this optocoupler is suitable for “safe electrical insulation” only within the safety limit data. Compliance with the safety ratings shall be ensured by means of protective circuits.

Parameter		Characteristics
Installation Classifications per DIN VDE 0110/1.89 Table 1, For Rated Mains Voltage	< 150 V _{RMS}	I–IV
	< 300 V _{RMS}	I–III
Climatic Classification		40/110/21
Pollution Degree (DIN VDE 0110/1.89)		2
Comparative Tracking Index		175

Symbol	Parameter	Value	Unit
V _{PR}	Input-to-Output Test Voltage, Method A, V _{IORM} × 1.6 = V _{PR} , Type and Sample Test with t _m = 10 s, Partial Discharge < 5 pC	904	V _{peak}
	Input-to-Output Test Voltage, Method B, V _{IORM} × 1.875 = V _{PR} , 100% Production Test with t _m = 1 s, Partial Discharge < 5 pC	1060	V _{peak}
V _{IORM}	Maximum Working Insulation Voltage	565	V _{peak}
V _{IOTM}	Highest Allowable Over-Voltage	4000	V _{peak}
	External Creepage	≥ 5	mm
	External Clearance	≥ 5	mm
DTI	Distance Through Insulation (Insulation Thickness)	≥ 0.4	mm
T _S	Case Temperature ⁽¹⁾	150	°C
I _{S,INPUT}	Input Current ⁽¹⁾	200	mA
P _{S,OUTPUT}	Output Power ⁽¹⁾	300	mW
R _{IO}	Insulation Resistance at T _S , V _{IO} = 500 V ⁽¹⁾	> 10 ⁹	Ω

Note:

1. Safety limit values – maximum values allowed in the event of a failure.

Pin Definitions

Number	Name	Function Description
1	ANODE	Anode
3	CATHODE	Cathode
4	GND	Output Ground
5	V _O	Output Voltage
6	V _{DD}	Output Supply Voltage

Absolute Maximum Ratings

Stresses exceeding the absolute maximum ratings may damage the device. The device may not function or be operable above the recommended operating conditions and stressing the parts to these levels is not recommended. In addition, extended exposure to stresses above the recommended operating conditions may affect device reliability. The absolute maximum ratings are stress ratings only. T_A = 25°C unless otherwise specified.

Symbol	Parameter	Value	Unit
T _{STG}	Storage Temperature	-40 to +125	°C
T _{OPR}	Operating Temperature	-40 to +110	°C
T _J	Junction Temperature	-40 to +125	°C
T _{SOL}	Lead Solder Temperature (Refer to Reflow Temperature Profile)	260 for 10 seconds	°C
I _F	Forward Current	20	mA
V _R	Reverse Voltage	5	V
V _{DD}	Supply Voltage	0 to 6.0	V
V _O	Output Voltage	-0.5 to V _{DD} + 0.5	V
I _O	Average Output Current	10	mA
PD _I	Input Power Dissipation ⁽²⁾⁽⁴⁾	40	mW
PD _O	Output Power Dissipation ⁽³⁾⁽⁴⁾	70	mW

Notes:

- Derate linearly from 95°C at a rate of -1.4 mW/°C
- Derate linearly from 100°C at a rate of -3.47 mW/°C.
- Functional operation under these conditions is not implied. Permanent damage may occur if the device is subjected to conditions outside these ratings.

Recommended Operating Conditions

The Recommended Operating Conditions table defines the conditions for actual device operation. Recommended operating conditions are specified to ensure optimal performance to the datasheet specifications. Fairchild does not recommend exceeding them or designing to Absolute Maximum Ratings.

Symbol	Parameter	Min.	Max.	Unit
T _A	Ambient Operating Temperature	-40	+110	°C
V _{DD}	Supply Voltages ⁽⁵⁾	3.0	5.5	V
V _{FL}	Logic Low Input Voltage	0	0.8	V
I _{FH}	Logic High Input Current	5	16	mA
I _{OL}	Logic Low Output Current	0	7	mA

Note:

- 0.1µF bypass capacitor must be connected between 4 and 6.

Electrical Characteristics

Apply over all recommended conditions. $T_A = -40^{\circ}\text{C}$ to $+110^{\circ}\text{C}$, $3.0\text{ V} \leq V_{DD} \leq 5.5\text{ V}$, unless otherwise specified. Typical value is measured at $T_A = 25^{\circ}\text{C}$ and $V_{DD} = 3.3\text{ V}$.

Symbol	Parameter	Test Conditions	Min.	Typ.	Max.	Unit
INPUT CHARACTERISTICS						
V_F	Forward Voltage	$I_F = 10\text{ mA}$ (Figure 2)	1.05	1.35	1.8	V
BV_R	Input Reverse Breakdown Voltage	$I_R = 10\text{ }\mu\text{A}$	5	15		V
I_{FHL}	Threshold Input Current	(Figure 3)		2.8	5.0	mA
OUTPUT CHARACTERISTICS						
I_{DDL}	Logic Low Output Supply Current	$V_{DD} = 3.3\text{ V}$, $I_F = 10\text{ mA}$ (Figures 4 and 6)		3.3	4.8	mA
		$V_{DD} = 5.0\text{ V}$, $I_F = 10\text{ mA}$ (Figures 4 and 7)		4.0	5.0	mA
I_{DDH}	Logic High Output Supply Current	$V_{DD} = 3.3\text{ V}$, $I_F = 0\text{ mA}$ (Figure 5)		3.3	4.8	mA
		$V_{DD} = 5.0\text{ V}$, $I_F = 0\text{ mA}$ (Figure 5)		4.0	5.0	mA
V_{OH}	Logic High Output Voltage	$V_{DD} = 3.3\text{ V}$, $I_O = -20\text{ }\mu\text{A}$, $I_F = 0\text{ mA}$	$V_{DD} - 0.1\text{ V}$	3.3		V
		$V_{DD} = 3.3\text{ V}$, $I_O = -4\text{ mA}$, $I_F = 0\text{ mA}$	$V_{DD} - 0.5\text{ V}$	3.1		V
		$V_{DD} = 5.0\text{ V}$, $I_O = -20\text{ }\mu\text{A}$, $I_F = 0\text{ mA}$	$V_{DD} - 0.1\text{ V}$	5.0		V
		$V_{DD} = 5.0\text{ V}$, $I_O = -4\text{ mA}$, $I_F = 0\text{ mA}$	$V_{DD} - 0.5\text{ V}$	4.9		V
V_{OL}	Logic Low Output Voltage	$I_O = 20\text{ }\mu\text{A}$, $I_F = 10\text{ mA}$		0.0027	0.01	V
		$I_O = 4\text{ mA}$, $I_F = 10\text{ mA}$		0.27	0.80	V

Electrical Characteristics (Continued)

Apply over all recommended conditions. $T_A = -40^{\circ}\text{C}$ to $+110^{\circ}\text{C}$, $3.0\text{ V} \leq V_{DD} \leq 5.5\text{ V}$, unless otherwise specified. Typical value is measured at $T_A = 25^{\circ}\text{C}$ and $V_{DD} = 3.3\text{ V}$.

Switching Characteristics

Symbol	Parameter	Test Conditions	Min.	Typ.	Max.	Unit
Date Rate ⁽⁶⁾					20	Mbps
t_{PW}	Pulse Width		50			ns
t_{PHL}	Propagation Delay Time to Logic Low Output	$C_L = 15\text{ pF}$ (Figures 8, 9, and 13)		31	55	ns
t_{PLH}	Propagation Delay Time to Logic High Output	$C_L = 15\text{ pF}$ (Figures 8, 9, and 13)		25	55	ns
PWD	Pulse Width Distortion, $ t_{PHL} - t_{PLH} $	$C_L = 15\text{ pF}$ (Figures 10 and 11)		5.5	20	ns
t_{PSK}	Propagation Delay Skew	$C_L = 15\text{ pF}$ ⁽⁷⁾			30	ns
t_R	Output Rise Time (10% to 90%)	(Figure 12 and 13)		5.8		ns
t_F	Output Fall Time (90% to 10%)	(Figure 12 and 13)		5.3		ns
$ CM_H $	Common Mode Transient Immunity at Output High	$I_F = 0\text{ mA}$, $V_O > 0.8 V_{DD}$, $V_{CM} = 1000\text{ V}$, $T_A = 25^{\circ}\text{C}$, (Figure 14) ⁽⁸⁾	20	40		kV/ μs
$ CM_L $	Common Mode Transient Immunity at Output Low	$I_F = 5\text{ mA}$, $V_O < 0.8\text{ V}$, $V_{CM} = 1000\text{ V}$, $T_A = 25^{\circ}\text{C}$, (Figure 14) ⁽⁸⁾	20	40		kV/ μs
C_{PDDO}	Output Dynamic Power Dissipation Capacitance ⁽⁹⁾			4		pF

Notes:

- Data rate is based on 10 MHz, 50% NRZ pattern with a 50 nsec minimum bit time.
- t_{PSK} is equal to the magnitude of the worst case difference in t_{PHL} and/or t_{PLH} that will be seen between any two units from the same manufacturing date code that are operated at same case temperature ($\pm 5^{\circ}\text{C}$), at the same operating conditions, with equal loads ($R_L = 350\ \Omega$ and $C_L = 15\text{ pF}$), and with an input rise time less than 5 ns.
- Common mode transient immunity at output high is the maximum tolerable positive dV_{cm}/dt on the leading edge of the common mode impulse signal, V_{cm} , to assure that the output will remain high. Common mode transient immunity at output low is the maximum tolerable negative dV_{cm}/dt on the trailing edge of the common pulse signal, V_{cm} , to assure that the output will remain low.
- Unloaded dynamic power dissipation is calculated as follows: $C_{PD} \times V_{DD} \times f + I_{DD} + V_{PD}$ where f is switched time in MHz.

Isolation Characteristics

Symbol	Parameter	Conditions	Min.	Typ.	Max.	Unit
V_{ISO}	Input-Output Isolation Voltage	$f = 60\text{ Hz}$, $t = 1.0\text{ minute}$, $I_{I-O} \leq 10\ \mu\text{A}$ ⁽¹⁰⁾⁽¹¹⁾	3750			$V_{AC_{RMS}}$
R_{ISO}	Isolation Resistance	$V_{I-O} = 500\text{ V}$ ⁽¹⁰⁾	10^{11}			Ω
C_{ISO}	Isolation Capacitance	$V_{I-O} = 0\text{ V}$, $f = 1.0\text{ MHz}$ ⁽¹⁰⁾		0.2		pF

Notes:

- Device is considered a two terminal device: pins 1, and 3 are shorted together and pins 4, 5, and 6 are shorted together.
- 11.3,750 $V_{AC_{RMS}}$ for 1 minute duration is equivalent to 4,500 $V_{AC_{RMS}}$ for 1 second duration.

Typical Performance Curves

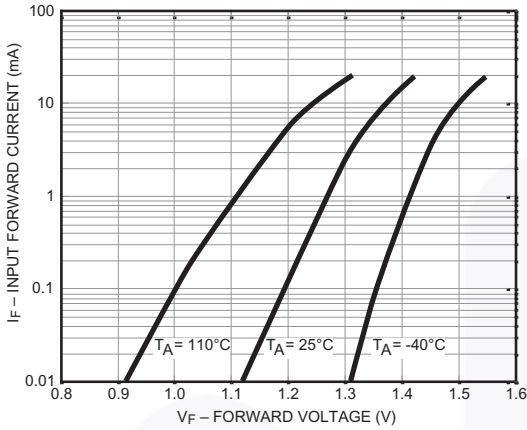

Figure 2. Input Forward Current vs. Forward Voltage

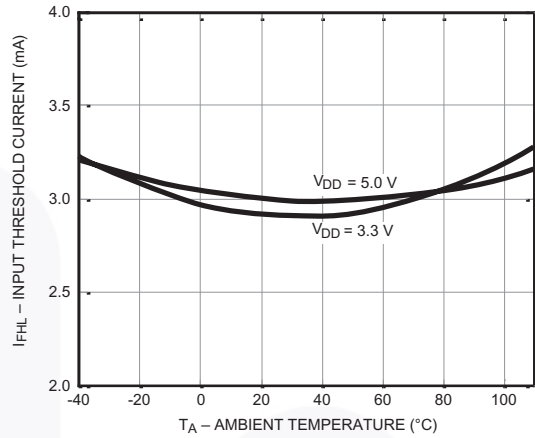

Figure 3. Input Threshold Current vs. Ambient Temperature

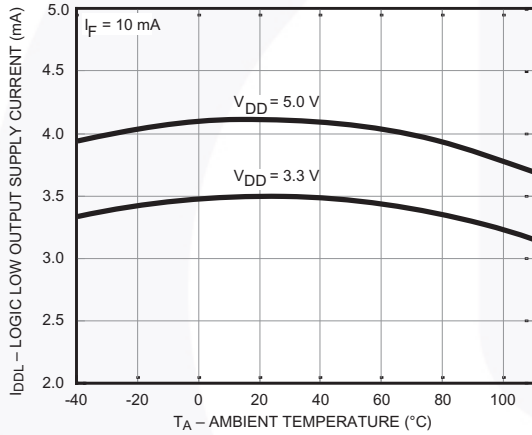

Figure 4. Logic Low Output Supply Current vs. Ambient Temperature

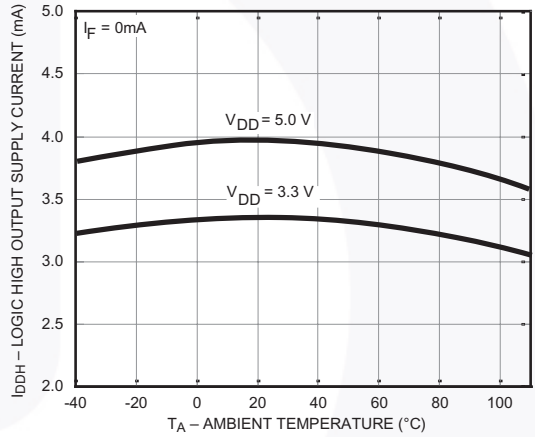

Figure 5. Logic High Output Supply Current vs. Ambient Temperature

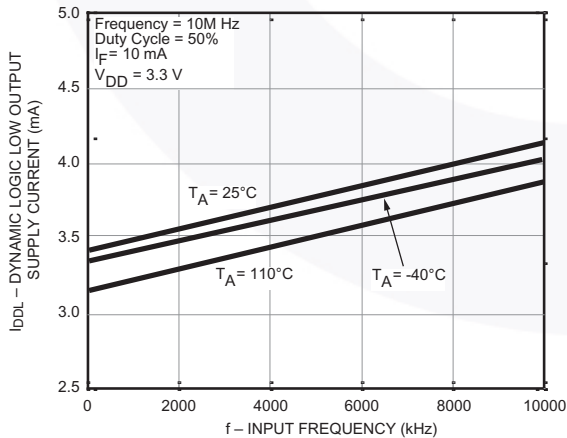

Figure 6. Dynamic Logic Low Output Supply Current vs. Input Frequency (V_{DD} = 3.3V)

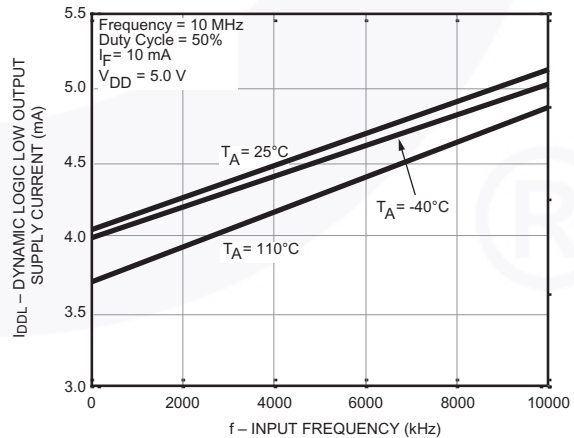

Figure 7. Dynamic Logic Low Output Supply Current vs. Input Frequency (V_{DD} = 5.0V)

Typical Performance Curves (Continued)

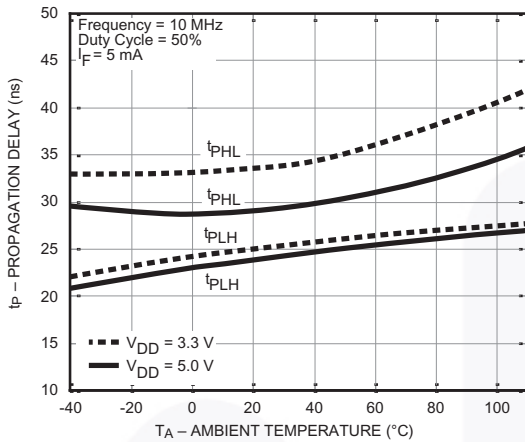

Figure 8. Propagation Delay vs. Ambient Temperature

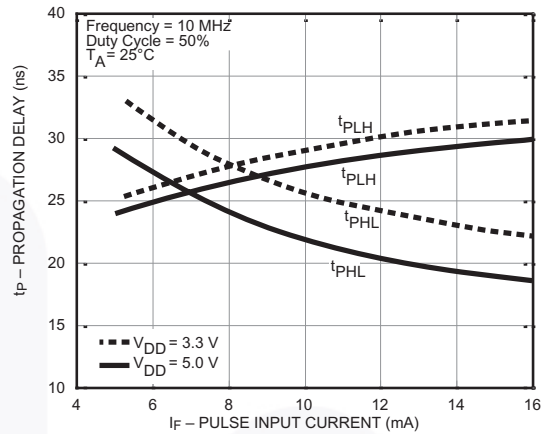

Figure 9. Propagation Delay vs. Pulse Input Current

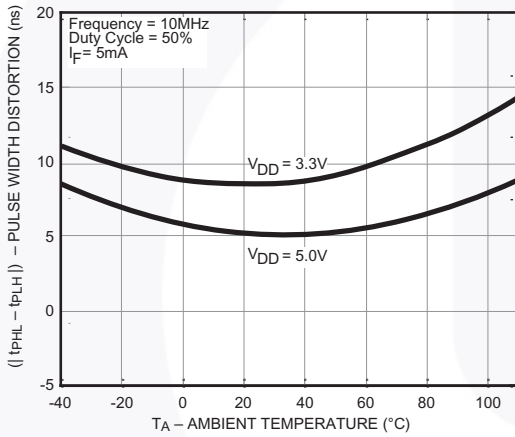

Figure 10. Pulse Width Distortion vs. Ambient Temperature

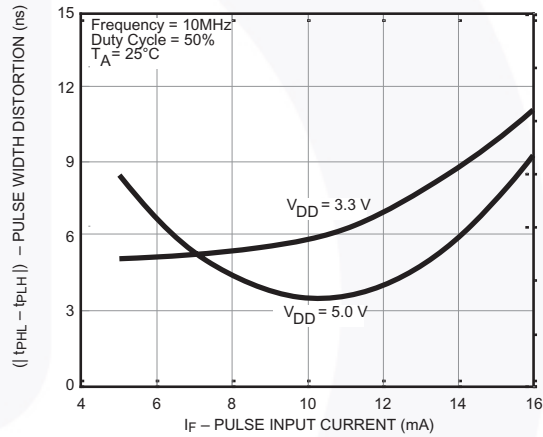

Figure 11. Pulse Width Distortion vs. Pulse Input Current

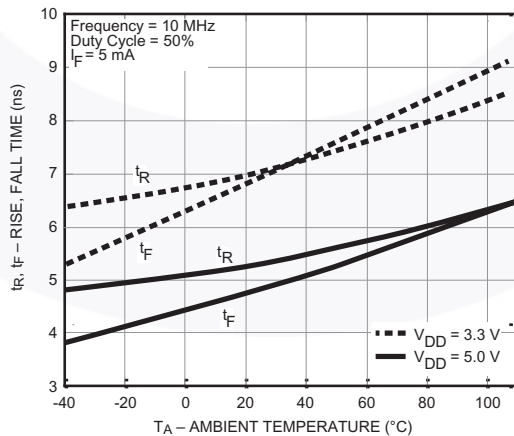

Figure 12. Rise and Fall Time vs. Ambient Temperature

Schematics

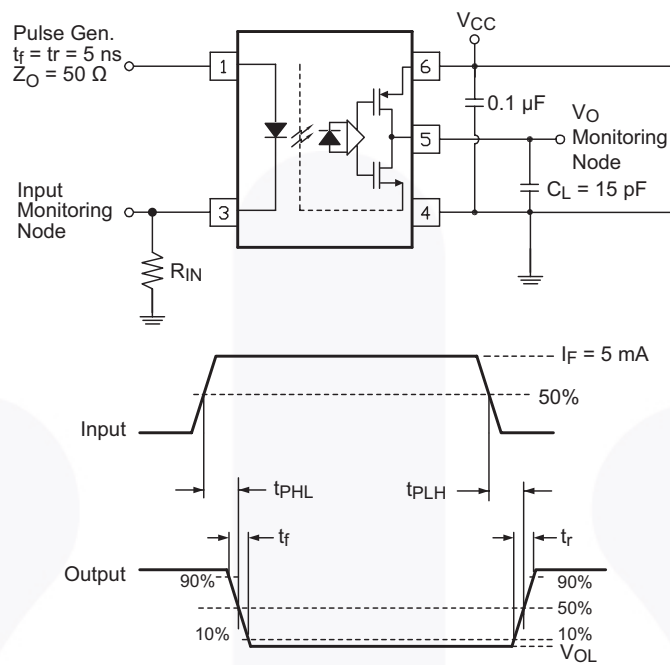

Figure 13. Test Circuit for Propagation Delay Time, Rise Time and Fall Time

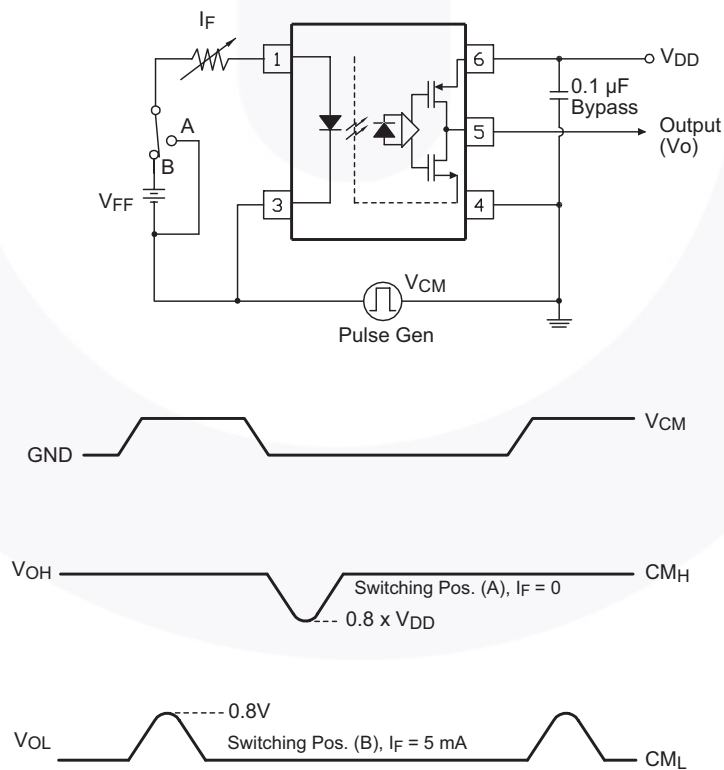

Figure 14. Test Circuit for Instantaneous Common Mode Rejection Voltage

Reflow Profile

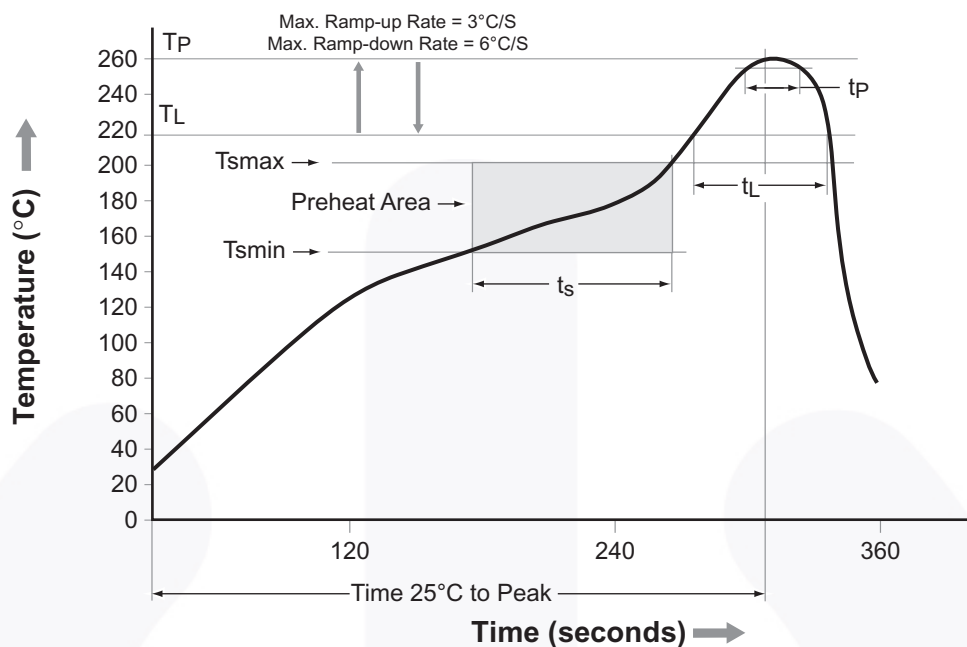



Figure 15. Reflow Profile

Profile Feature	Pb-Free Assembly Profile
Temperature Min. (T _{smin})	150°C
Temperature Max. (T _{smax})	200°C
Time (t _s) from (T _{smin} to T _{smax})	60–120 seconds
Ramp-up Rate (t _L to t _p)	3°C/second maximum
Liquidous Temperature (T _L)	217°C
Time (t _L) Maintained Above (T _L)	60–150 seconds
Peak Body Package Temperature	260°C +0°C / -5°C
Time (t _p) within 5°C of 260°C	30 seconds
Ramp-down Rate (T _P to T _L)	6°C/second maximum
Time 25°C to Peak Temperature	8 minutes maximum

Ordering Information

Part Number	Package	Packing Method
FODM8071	Mini-Flat 5-Pin	Tube (100 Units)
FODM8071R2	Mini-Flat 5-Pin	Tape and Reel (2500 Units)
FODM8071V	Mini-Flat 5-Pin, DIN EN/IEC60747-5-5 Option	Tube (100 Units)
FODM8071R2V	Mini-Flat 5-Pin, DIN EN/IEC60747-5-5 Option	Tape and Reel (2500 Units)

 All packages are lead free per JEDEC: J-STD-020B standard.

Marking Information

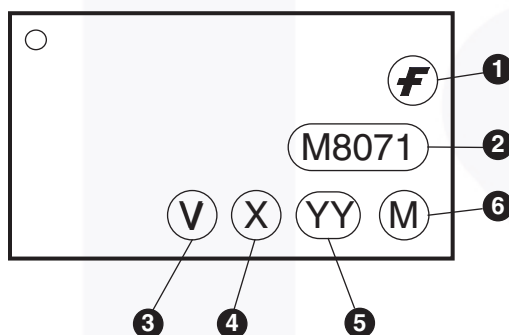
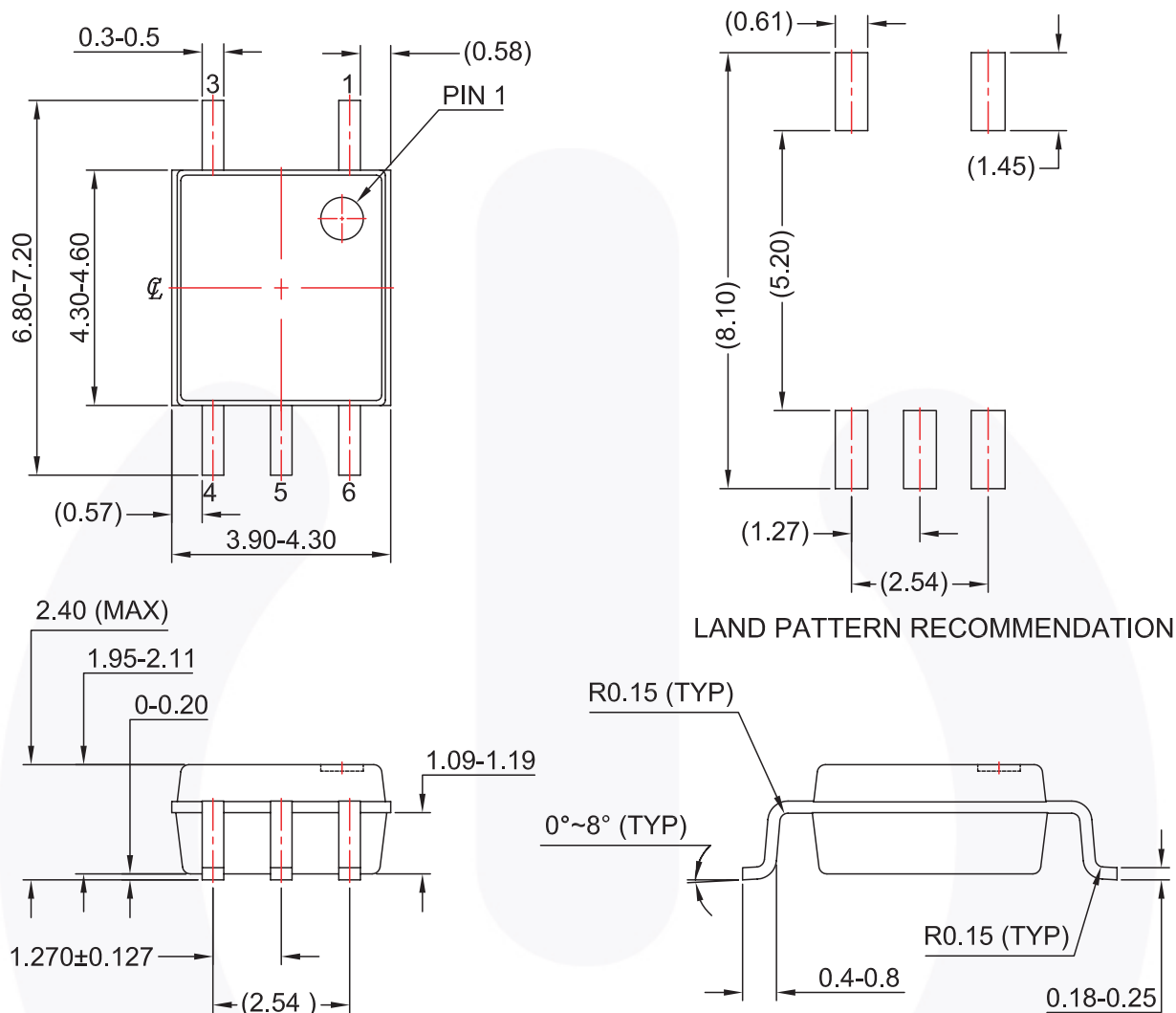

Figure 16. Top Mark

Table 1. Top Mark Definitions

1	Fairchild Logo
2	Device Number
3	DIN EN/IEC60747-5-5 Option (only appears on component ordered with this option)
4	One-Digit Year Code, e.g., "4"
5	Digit Work Week, Ranging from "01" to "53"
6	Assembly Package Code

Package Dimensions



NOTES:

- A) NO STANDARD APPLIES TO THIS PACKAGE
- B) ALL DIMENSIONS ARE IN MILLIMETERS.
- C) DIMENSIONS ARE EXCLUSIVE OF BURRS, MOLD FLASH, AND TIE BAR EXTRUSION
- D) DWG FILENAME AND REVISION : MKT-MFP05Arev3.



Figure 17. MLP 5L Package



TRADEMARKS

The following includes registered and unregistered trademarks and service marks, owned by Fairchild Semiconductor and/or its global subsidiaries, and is not intended to be an exhaustive list of all such trademarks.

- | | | | |
|--------------------------|--|---------------------------------------|------------------|
| AccuPower™ | F-PFS™ | OPTOPLANAR® | SYSTEM GENERAL® |
| AttitudeEngine™ | FRFET® | Power Supply WebDesigner™ | TinyBoost® |
| Awinda® | Global Power Resource SM | PowerTrench® | TinyBuck® |
| AX-CAP®* | GreenBridge™ | PowerXS™ | TinyCalc™ |
| BitSiC™ | Green FPS™ | Programmable Active Droop™ | TinyLogic® |
| Build it Now™ | Green FPS™ e-Series™ | QFET® | TINYOPTO™ |
| CorePLUS™ | Gmax™ | QS™ | TinyPower™ |
| CorePOWER™ | GTO™ | Quiet Series™ | TinyPWM™ |
| CROSSVOL™ | IntelliMAX™ | RapidConfigure™ | TinyWire™ |
| CTL™ | ISOPLANAR™ | Saving our world, 1mW/W/kW at a time™ | TranSiC™ |
| Current Transfer Logic™ | Making Small Speakers Sound Louder and Better™ | SignalWise™ | TriFault Detect™ |
| DEUXPEED® | MegaBuck™ | SmartMax™ | TRUECURRENT®* |
| Dual Cool™ | MICROCOUPLER™ | SMART START™ | μSerDes™ |
| EcoSPARK® | MicroFET™ | Solutions for Your Success™ | UHC® |
| EfficientMax™ | MicroPak™ | SPM® | Ultra FRFET™ |
| ESBC™ | MicroPak2™ | STEALTH™ | UniFET™ |
| F [®] | MillerDrive™ | SuperFET® | VCX™ |
| Fairchild® | MotionMax™ | SuperSOT™-3 | VisualMax™ |
| Fairchild Semiconductor® | MotionGrid® | SuperSOT™-6 | VoltagePlus™ |
| FACT Quiet Series™ | MTi® | SuperSOT™-8 | XS™ |
| FACT® | MTx® | SupreMOS® | Xsens™ |
| FastvCore™ | MVN® | SyncFET™ | 仙童™ |
| FETBench™ | mWSaver® | Sync-Lock™ | |
| FPS™ | OptoHiT™ | | |
| | OPTOLOGIC® | | |

* Trademarks of System General Corporation, used under license by Fairchild Semiconductor.

DISCLAIMER

FAIRCHILD SEMICONDUCTOR RESERVES THE RIGHT TO MAKE CHANGES WITHOUT FURTHER NOTICE TO ANY PRODUCTS HEREIN TO IMPROVE RELIABILITY, FUNCTION, OR DESIGN. TO OBTAIN THE LATEST, MOST UP-TO-DATE DATASHEET AND PRODUCT INFORMATION, VISIT OUR WEBSITE AT [HTTP://WWW.FAIRCHILDSEMI.COM](http://www.fairchildsemi.com). FAIRCHILD DOES NOT ASSUME ANY LIABILITY ARISING OUT OF THE APPLICATION OR USE OF ANY PRODUCT OR CIRCUIT DESCRIBED HEREIN; NEITHER DOES IT CONVEY ANY LICENSE UNDER ITS PATENT RIGHTS, NOR THE RIGHTS OF OTHERS. THESE SPECIFICATIONS DO NOT EXPAND THE TERMS OF FAIRCHILD'S WORLDWIDE TERMS AND CONDITIONS, SPECIFICALLY THE WARRANTY THEREIN, WHICH COVERS THESE PRODUCTS.

AUTHORIZED USE

Unless otherwise specified in this data sheet, this product is a standard commercial product and is not intended for use in applications that require extraordinary levels of quality and reliability. This product may not be used in the following applications, unless specifically approved in writing by a Fairchild officer: (1) automotive or other transportation, (2) military/aerospace, (3) any safety critical application – including life critical medical equipment – where the failure of the Fairchild product reasonably would be expected to result in personal injury, death or property damage. Customer's use of this product is subject to agreement of this Authorized Use policy. In the event of an unauthorized use of Fairchild's product, Fairchild accepts no liability in the event of product failure. In other respects, this product shall be subject to Fairchild's Worldwide Terms and Conditions of Sale, unless a separate agreement has been signed by both Parties.

ANTI-COUNTERFEITING POLICY

Fairchild Semiconductor Corporation's Anti-Counterfeiting Policy. Fairchild's Anti-Counterfeiting Policy is also stated on our external website, www.fairchildsemi.com, under Terms of Use

Counterfeiting of semiconductor parts is a growing problem in the industry. All manufacturers of semiconductor products are experiencing counterfeiting of their parts. Customers who inadvertently purchase counterfeit parts experience many problems such as loss of brand reputation, substandard performance, failed applications, and increased cost of production and manufacturing delays. Fairchild is taking strong measures to protect ourselves and our customers from the proliferation of counterfeit parts. Fairchild strongly encourages customers to purchase Fairchild parts either directly from Fairchild or from Authorized Fairchild Distributors who are listed by country on our web page cited above. Products customers buy either from Fairchild directly or from Authorized Fairchild Distributors are genuine parts, have full traceability, meet Fairchild's quality standards for handling and storage and provide access to Fairchild's full range of up-to-date technical and product information. Fairchild and our Authorized Distributors will stand behind all warranties and will appropriately address any warranty issues that may arise. Fairchild will not provide any warranty coverage or other assistance for parts bought from Unauthorized Sources. Fairchild is committed to combat this global problem and encourage our customers to do their part in stopping this practice by buying direct or from authorized distributors.

PRODUCT STATUS DEFINITIONS

Definition of Terms

Datasheet Identification	Product Status	Definition
Advance Information	Formative / In Design	Datasheet contains the design specifications for product development. Specifications may change in any manner without notice.
Preliminary	First Production	Datasheet contains preliminary data; supplementary data will be published at a later date. Fairchild Semiconductor reserves the right to make changes at any time without notice to improve design.
No Identification Needed	Full Production	Datasheet contains final specifications. Fairchild Semiconductor reserves the right to make changes at any time without notice to improve the design.
Obsolete	Not In Production	Datasheet contains specifications on a product that is discontinued by Fairchild Semiconductor. The datasheet is for reference information only.

Rev. I76

ON Semiconductor and  are trademarks of Semiconductor Components Industries, LLC dba ON Semiconductor or its subsidiaries in the United States and/or other countries. ON Semiconductor owns the rights to a number of patents, trademarks, copyrights, trade secrets, and other intellectual property. A listing of ON Semiconductor's product/patent coverage may be accessed at www.onsemi.com/site/pdf/Patent-Marking.pdf. ON Semiconductor reserves the right to make changes without further notice to any products herein. ON Semiconductor makes no warranty, representation or guarantee regarding the suitability of its products for any particular purpose, nor does ON Semiconductor assume any liability arising out of the application or use of any product or circuit, and specifically disclaims any and all liability, including without limitation special, consequential or incidental damages. Buyer is responsible for its products and applications using ON Semiconductor products, including compliance with all laws, regulations and safety requirements or standards, regardless of any support or applications information provided by ON Semiconductor. "Typical" parameters which may be provided in ON Semiconductor data sheets and/or specifications can and do vary in different applications and actual performance may vary over time. All operating parameters, including "Typicals" must be validated for each customer application by customer's technical experts. ON Semiconductor does not convey any license under its patent rights nor the rights of others. ON Semiconductor products are not designed, intended, or authorized for use as a critical component in life support systems or any FDA Class 3 medical devices or medical devices with a same or similar classification in a foreign jurisdiction or any devices intended for implantation in the human body. Should Buyer purchase or use ON Semiconductor products for any such unintended or unauthorized application, Buyer shall indemnify and hold ON Semiconductor and its officers, employees, subsidiaries, affiliates, and distributors harmless against all claims, costs, damages, and expenses, and reasonable attorney fees arising out of, directly or indirectly, any claim of personal injury or death associated with such unintended or unauthorized use, even if such claim alleges that ON Semiconductor was negligent regarding the design or manufacture of the part. ON Semiconductor is an Equal Opportunity/Affirmative Action Employer. This literature is subject to all applicable copyright laws and is not for resale in any manner.

PUBLICATION ORDERING INFORMATION

LITERATURE FULFILLMENT:

Literature Distribution Center for ON Semiconductor
19521 E. 32nd Pkwy, Aurora, Colorado 80011 USA
Phone: 303-675-2175 or 800-344-3860 Toll Free USA/Canada
Fax: 303-675-2176 or 800-344-3867 Toll Free USA/Canada
Email: orderlit@onsemi.com

N. American Technical Support: 800-282-9855 Toll Free
USA/Canada
Europe, Middle East and Africa Technical Support:
Phone: 421 33 790 2910
Japan Customer Focus Center
Phone: 81-3-5817-1050

ON Semiconductor Website: www.onsemi.com
Order Literature: <http://www.onsemi.com/orderlit>
For additional information, please contact your local
Sales Representative

Mouser Electronics

Authorized Distributor

Click to View Pricing, Inventory, Delivery & Lifecycle Information:

[onsemi:](#)

[FODM8071](#) [FODM8071R2](#)