

P5100
2500 V 250 MHz Oscilloscope Probe
Instructions



070-8151-05

Tektronix

P5100

2500 V 250 MHz Oscilloscope Probe

Instructions

Warning

The servicing instructions are for use by qualified personnel only. To avoid personal injury, do not perform any servicing unless you are qualified to do so. Refer to all safety summaries prior to performing service.

www.tektronix.com

070-8151-05

Tektronix

Copyright © Tektronix. All rights reserved. Licensed software products are owned by Tektronix or its subsidiaries or suppliers, and are protected by national copyright laws and international treaty provisions.

Tektronix products are covered by U.S. and foreign patents, issued and pending. Information in this publication supersedes that in all previously published material. Specifications and price change privileges reserved.

TEKTRONIX and TEK are registered trademarks of Tektronix, Inc.

Contacting Tektronix

Tektronix, Inc.
14200 SW Karl Braun Drive
P.O. Box 500
Beaverton, OR 97077
USA

For product information, sales, service, and technical support:

- In North America, call 1-800-833-9200.
- Worldwide, visit www.tektronix.com to find contacts in your area.

Warranty

Tektronix warrants that this product will be free from defects in materials and workmanship for a period of one (1) year from the date of shipment. If any such product proves defective during this warranty period, Tektronix, at its option, either will repair the defective product without charge for parts and labor, or will provide a replacement in exchange for the defective product. Parts, modules and replacement products used by Tektronix for warranty work may be new or reconditioned to like new performance. All replaced parts, modules and products become the property of Tektronix.

In order to obtain service under this warranty, Customer must notify Tektronix of the defect before the expiration of the warranty period and make suitable arrangements for the performance of service. Customer shall be responsible for packaging and shipping the defective product to the service center designated by Tektronix, with shipping charges prepaid. Tektronix shall pay for the return of the product to Customer if the shipment is to a location within the country in which the Tektronix service center is located. Customer shall be responsible for paying all shipping charges, duties, taxes, and any other charges for products returned to any other locations.

This warranty shall not apply to any defect, failure or damage caused by improper use or improper or inadequate maintenance and care. Tektronix shall not be obligated to furnish service under this warranty a) to repair damage resulting from attempts by personnel other than Tektronix representatives to install, repair or service the product; b) to repair damage resulting from improper use or connection to incompatible equipment; c) to repair any damage or malfunction caused by the use of non-Tektronix supplies; or d) to service a product that has been modified or integrated with other products when the effect of such modification or integration increases the time or difficulty of servicing the product.

THIS WARRANTY IS GIVEN BY TEKTRONIX WITH RESPECT TO THE PRODUCT IN LIEU OF ANY OTHER WARRANTIES, EXPRESS OR IMPLIED. TEKTRONIX AND ITS VENDORS DISCLAIM ANY IMPLIED WARRANTIES OF MERCHANTABILITY OR FITNESS FOR A PARTICULAR PURPOSE. TEKTRONIX' RESPONSIBILITY TO REPAIR OR REPLACE DEFECTIVE PRODUCTS IS THE SOLE AND EXCLUSIVE REMEDY PROVIDED TO THE CUSTOMER FOR BREACH OF THIS WARRANTY. TEKTRONIX AND ITS VENDORS WILL NOT BE LIABLE FOR ANY INDIRECT, SPECIAL, INCIDENTAL, OR CONSEQUENTIAL DAMAGES IRRESPECTIVE OF WHETHER TEKTRONIX OR THE VENDOR HAS ADVANCE NOTICE OF THE POSSIBILITY OF SUCH DAMAGES.

[W2 – 15AUG04]

Table of Contents

General Safety Summary	ii
Service Safety Summary	iv
Compliance Information	v
Safety Compliance	v
Environmental Considerations	vii
Features and Accessories	1
Operating Basics	5
Maximum Nondestructive Input Voltage	5
Grounding the Probe	5
Ground Lead Length	6
User Maintenance	7
Low Frequency (LF) Probe Compensation	7
Cleaning	8
Preparation for Shipment	8
Performance Verification	9
DC Accuracy Check	10
Bandwidth Check	11
Adjustments	12
DC Gain and High Frequency (HF) Compensation	12
Maintenance	17
Replacing Probe Parts	17
Specifications	19
Replaceable Parts	23

General Safety Summary

Review the following safety precautions to avoid injury and prevent damage to this product or any products connected to it.

To avoid potential hazards, use this product only as specified.

Only qualified personnel should perform service procedures.

While using this product, you may need to access other parts of a larger system. Read the safety sections of the other component manuals for warnings and cautions related to operating the system.

To Avoid Fire or Personal Injury

Connect and Disconnect Properly. Connect the probe output to the measurement instrument before connecting the probe to the circuit under test. Connect the probe reference lead to the circuit under test before connecting the probe input. Disconnect the probe input and the probe reference lead from the circuit under test before disconnecting the probe from the measurement instrument.

Observe All Terminal Ratings. To avoid fire or shock hazard, observe all ratings and markings on the product. Consult the product manual for further ratings information before making connections to the product.

Connect the probe reference lead to earth ground only.

Do not apply a potential to any terminal, including the common terminal, that exceeds the maximum rating of that terminal.

Do Not Operate Without Covers. Do not operate this product with covers or panels removed.

Do Not Operate With Suspected Failures. If you suspect that there is damage to this product, have it inspected by qualified service personnel.

Avoid Exposed Circuitry. Do not touch exposed connections and components when power is present.

Do Not Operate in Wet/Damp Conditions.

Do Not Operate in an Explosive Atmosphere.

Keep Product Surfaces Clean and Dry.

Terms in this Manual These terms may appear in this manual:



WARNING. *Warning statements identify conditions or practices that could result in injury or loss of life.*



CAUTION. *Caution statements identify conditions or practices that could result in damage to this product or other property.*

Symbols and Terms on the Product

These terms may appear on the product:

- DANGER indicates an injury hazard immediately accessible as you read the marking.
- WARNING indicates an injury hazard not immediately accessible as you read the marking.
- CAUTION indicates a hazard to property including the product.

The following symbol(s) may appear on the product:



CAUTION
Refer to Manual



WARNING
High Voltage

Service Safety Summary

Only qualified personnel should perform service procedures. Read this *Service Safety Summary* and the *General Safety Summary* before performing any service procedures.

Do Not Service Alone. Do not perform internal service or adjustments of this product unless another person capable of rendering first aid and resuscitation is present.

Disconnect Power. To avoid electric shock, switch off the instrument power, then disconnect the power cord from the mains power.

Use Care When Servicing With Power On. Dangerous voltages or currents may exist in this product. Disconnect power, remove battery (if applicable), and disconnect test leads before removing protective panels, soldering, or replacing components.

To avoid electric shock, do not touch exposed connections.

Compliance Information

This section lists the safety and environmental standards with which the instrument complies.

Safety Compliance

EC Declaration of Conformity – Low Voltage

Compliance was demonstrated to the following specification as listed in the Official Journal of the European Communities:

Low Voltage Directive 2006/95/EC.

- EN 61010-031: 2002. Particular requirements for handheld probe assemblies for electrical measurement and test equipment.

U.S. Nationally Recognized Testing Laboratory Listing

- UL 3111-1, 1st Edition. Standard for Safety of Electrical Measuring and Testing Equipment.
- IEC 1010-2-031st Edition. Particular requirements for handheld probe assemblies for electrical measurement and test equipment.

Canadian Certification

- CAN/CSA C22.2 No. 1010.1-92 Safety requirements for electrical equipment for measurement, control, and laboratory use. Part 1.

Additional Compliances

- IEC 61010-031: 2002. Particular requirements for handheld probe assemblies for electrical measurement and test equipment.

Equipment Type

Test and measuring equipment.

Safety Class

Class 1 – grounded product.

Pollution Degree Description

A measure of the contaminants that could occur in the environment around and within a product. Typically the internal environment inside a product is considered to be the same as the external. Products should be used only in the environment for which they are rated.

- Pollution Degree 1. No pollution or only dry, nonconductive pollution occurs. Products in this category are generally encapsulated, hermetically sealed, or located in clean rooms.
- Pollution Degree 2. Normally only dry, nonconductive pollution occurs. Occasionally a temporary conductivity that is caused by condensation must be expected. This location is a typical office/home environment. Temporary condensation occurs only when the product is out of service.

- Pollution Degree 3. Conductive pollution, or dry, nonconductive pollution that becomes conductive due to condensation. These are sheltered locations where neither temperature nor humidity is controlled. The area is protected from direct sunshine, rain, or direct wind.
- Pollution Degree 4. Pollution that generates persistent conductivity through conductive dust, rain, or snow. Typical outdoor locations.

Pollution Degree Pollution Degree 2 (as defined in IEC 61010-1). Note: Rated for indoor use only.

Measurement Category Descriptions Terminals on this product may have different installation (overvoltage) category designations. The installation categories are:

- Measurement Category IV. For measurements performed at the source of low-voltage installation.
- Measurement Category III. For measurements performed in the building installation.
- Measurement Category II. For measurements performed on circuits directly connected to the low-voltage installation.
- Measurement Category I. For measurements performed on circuits not directly connected to MAINS.

Measurement Category Measurement Category III (as defined in IEC 61010-1)

Environmental Considerations

This section provides information about the environmental impact of the product.

Product End-of-Life Handling

Observe the following guidelines when recycling an instrument or component:

Equipment Recycling. Production of this equipment required the extraction and use of natural resources. The equipment may contain substances that could be harmful to the environment or human health if improperly handled at the product's end of life. In order to avoid release of such substances into the environment and to reduce the use of natural resources, we encourage you to recycle this product in an appropriate system that will ensure that most of the materials are reused or recycled appropriately.



This symbol indicates that this product complies with the applicable European Union requirements according to Directives 2002/96/EC and 2006/66/EC on waste electrical and electronic equipment (WEEE) and batteries. For information about recycling options, check the Support/Service section of the Tektronix Web site (www.tektronix.com).

Restriction of Hazardous Substances

This product has been classified as Monitoring and Control equipment, and is outside the scope of the 2002/95/EC RoHS Directive.

Features and Accessories

The P5100 is a 100X, 2500 V (DC + peak AC), 1000 V CAT III oscilloscope probe that provides 250 MHz performance.

The P5100 probe is designed for ground-referenced measurements only. The P5100 probe is only rated CAT I for voltages exceeding 1000 VAC and not intended for mains voltages above 1000 VAC. A CAT I circuit is a non-mains energy limited circuit within equipment. Refer to the Specification section for more details.

The P5100 probe is compatible with all Class 1 (grounded) general-purpose oscilloscopes and with Tektronix ground-referenced oscilloscopes that automatically detect 100X probe attenuation and display the correct scale readout.



WARNING. *To avoid electric shock and possible injury, do not apply any voltage above earth ground potential (0-volt potential) to the probe common lead (do not float the common). The exposed metal on the probe compensation box is electrically connected to the probe common lead and therefore is at the same potential.*

The P5100 voltage probe is intended for use with ground-referenced oscilloscopes only. Do not float the oscilloscope by removing or isolating the ground pin from the AC power cord.

Do not use the P5100 voltage probe with any equipment with floating inputs, including the TPS2000 or THS700 series oscilloscopes.

To reduce risk of electric shock and fire, do not use this probe to measure high voltages (>1000 VAC or 1500 VDC) on power distribution systems.

To reduce the risk of electric shock, do not use accessories from any other product. Use only the accessories provided for the P5100 probe. The use of accessories for probes other than the P5100 probe may cause injury or death.

To reduce risk of electric shock and fire when using accessories with the probe, do not exceed the measurement category or rated voltage of either the probe or an accessory whichever is less. For example, when using the Probe Tip to BNC Adapter with the probe, do not exceed 500 V (DC + peak AC) CAT I.

P5100 Features and Standard Accessories

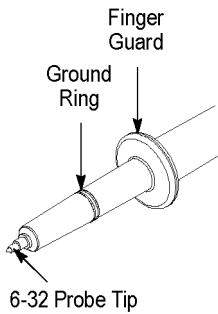

Probe Body - The probe body ground ring connection allows a short ground connection for optimal signal fidelity.

The probe tip is a 6-32 threaded post that accepts both standard and optional accessories. Keep the probe body and accessories clean and dry to reduce the risk of shock due to surface conduction.

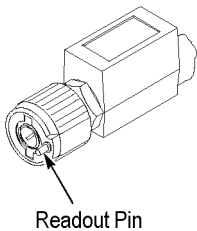

Compensation Box - The P5100 compensation box contains service-level adjustments such as the gain adjustment.

The P5100 is compatible with Tektronix ground-referenced oscilloscopes that automatically detect and display the 100X attenuation factor of the probe.

(If you have an older instrument with a lit vernier indicator, the 10X position will light. Multiply the reading by a factor of 10 to get the true value.)

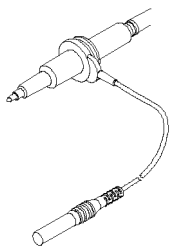

Ground Leads - The P5100 probe comes with a long and a short ground lead. Both ground leads connect to a removable crocodile clip.

Attach the ground lead to the probe body by inserting the probe head into the ground lead as shown.

The length of the ground lead directly impacts the fidelity of high-frequency signals. The longer the ground lead, the more the signal will be distorted. More information about the ground lead and signal quality is available. (See page 5, *Grounding the Probe*.)

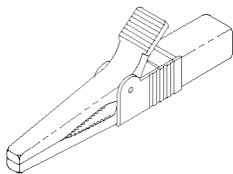

Crocodile Clip - The large crocodile clip attaches to the insulated banana connector on the long ground lead.

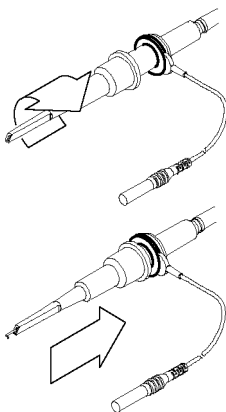

Small Hook Tip - Use the small hook tip for making connections to small conductors such as component leads.

Install the small hook tip by sliding it over the body of the probe and screwing it onto the threaded probe tip.



WARNING. To reduce risk of electric shock, always keep your fingers behind the finger guard on the probe body. When using hook-tip accessories, place your fingers in front of the finger guard only to retract the hook-tip accessory when you connect and disconnect the probe.

To use the tip, hold the probe body and pull the tip shield back. Hook the tip onto the circuit and release the shield. The hook tip will firmly hold the conductor under test.

P5100 Features and Standard Accessories

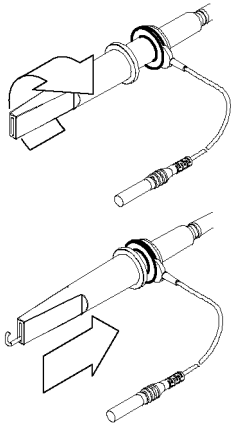

Large Hook Tip - Use the large hook tip when working with larger components such as bolt terminals and buss bars typically found in power distribution equipment.

Install the large hook tip by sliding it over the body of the probe and screwing it onto the threaded probe tip.

To use the tip, hold the probe body and pull the tip shield back. Hook the tip onto the circuit and release the shield. The hook tip will firmly hold the conductor under test.

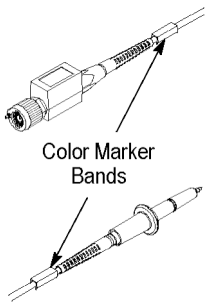

Color Marker Bands

Color Marker Bands - The color marker bands help you identify multiple probes in the circuit under test.

Clip the matching bands onto the cable at the probe head and compensation box to help identify probe channels at a glance.

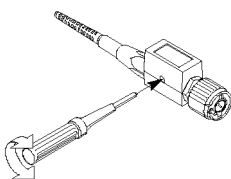

Adjustment Tool - Due to variations in oscilloscope input characteristics, the low-frequency compensation of the probe may need adjustment (in 10X attenuation only) after moving the probe from one oscilloscope channel to another.

If a 1 kHz calibrated square wave displayed at 1 ms/division shows significant differences between the leading and trailing edges, perform the following steps to optimize low-frequency compensation:

1. Connect the probe to the calibration signal on the oscilloscope front panel. **WARNING.** To avoid electric shock, only connect to the Probe Comp signal on the oscilloscope when making this adjustment.
2. Press AUTOSET or otherwise adjust your digitizing oscilloscope to display a stable waveform.
3. Adjust the trimmer in the probe until you see a perfectly flat-top square wave on the display.



WARNING. To avoid electric shock, only use the insulated adjustment tool when making compensation adjustments.

P5100 Optional Accessories

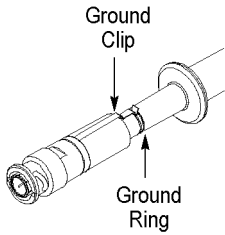

Probe Tip to BNC Adapter - This Probe Tip to BNC Adapter is intended only for use with performance verification and probe adjustment procedures, allowing the probe to be directly connected to BNC connectors of other test or signal generation equipment.



WARNING. To reduce risk of electric shock or fire, do not use the adapter for mains connections (for example, CAT II, CAT III, and CAT IV circuits), or for voltages exceeding 500 V (DC + peak AC). The Probe Tip to BNC Adapter is not rated for mains connections and not rated for any transient overvoltages (impulses) above the rated voltage (for example, when impulses are present, ensure that the maximum impulse is <math><500\text{ Vpk}</math> relative to ground before using this adapter).

Attach the adapter by pressing it onto the 6-32 probe tip and making sure that the ground clip makes contact with the ground ring.

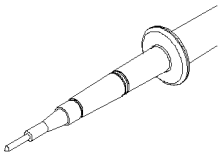

Rubber Spring Tip - Use the rubber spring tip to connect the P5100 probe to larger test sockets located in equipment or on printed circuit boards.

Connect the rubber spring tip by screwing it onto the threaded probe tip.

Operating Basics

Users need to know this information to get guaranteed performance from the P5100 probe. For best results, please read and apply this information.

Maximum Nondestructive Input Voltage

The P5100 probe is designed to be used in a high voltage environment; however, the voltage input rating of the probe decreases as the frequency of the applied signal increases. Please refer to the *Specifications* section of this manual for the maximum input voltage and frequency derating information.

Grounding the Probe

Connect the probe to the ground-referenced oscilloscope and then connect the ground lead to ground before making any measurements. Be careful that no part of the ground lead contacts voltage in the circuit under test. Except for the probe tip and BNC center conductor, all accessible metal (including the ground clip) is connected to the BNC shell.



WARNING. *To avoid electric shock and possible injury, do not apply any voltage above earth ground potential (0-volt potential) to the probe common lead (do not float the common). The exposed metal on the probe compensation box is electrically connected to the probe common lead and therefore is at the same potential.*

The P5100 voltage probe is intended for use with ground-referenced oscilloscopes only. Do not float the oscilloscope by removing or isolating the ground pin from the AC power cord. Do not use the P5100 voltage probe with any equipment with floating inputs, including the TPS2000 or THS700 series oscilloscopes.

Ground Lead Length

Always use as short a ground lead as possible between the probe head and circuit ground. The series inductance added by the probe tip and ground lead can result in a resonant circuit; this circuit may cause parasitic "ringing" visible within the bandwidth of your oscilloscope. (See Figure 1.) Ringing is not a concern when the probe is used with low frequency or long rise time signals.

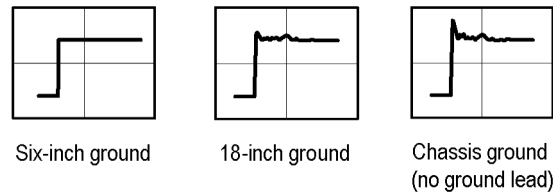

Figure 1: Waveform Distortion from Ground Lead Length

When you touch your probe tip to a circuit element, you are introducing a new resistance, capacitance, and inductance into the circuit. (See Figure 2.)

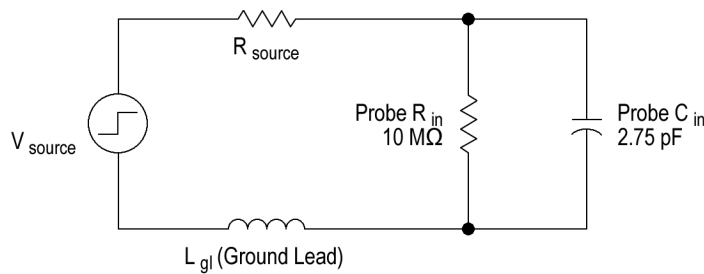

Figure 2: Probe Loading Equivalent Circuit

Ringings and rise time degradation can be masked if the frequency content of the signal degradation is beyond the bandwidth of the oscilloscope.

The preceding equation shows that reducing the ground lead inductance will raise the resonant frequency. If your measurements are affected by ringing, you can lower the inductance of your ground path (typically by shortening the ground lead) until the resonant frequency is well above the frequency of your measurements.

User Maintenance

This section covers the adjustments and maintenance that can be done by the user. Service-level adjustments must be done by a trained service person (see the Service Section of this manual for the procedure).

Low Frequency (LF) Probe Compensation

The low-frequency compensation of the P5100 probe must be checked every time that the probe is connected to a different oscilloscope input.

If the probe is used on more than one oscilloscope, service-level adjustments (for example, DC gain and high-frequency compensation) may be required. To determine if a service-level adjustment is required, perform the performance verification procedure on the probe. If a DC gain or High-Frequency compensation adjustment is needed, have these done by a trained service person. See the Service Section of this manual for the procedure.

A probe must be adjusted to match the input impedance of an oscilloscope in the same way that an antenna must be matched to a radio transmitter. If there is a mismatch between the two halves of the system, excessive distortion will result.

Because the probe attenuation is a 100x, a signal source of at least 5 V peak-to-peak at 10 kHz is ideal. The front panel calibrator on your oscilloscope may be adequate, or you can use an external signal source, such as a Tektronix AFG3000 or AWG5000.

Connect the probe to the signal source to display the test signal on your oscilloscope. To get a clear signal display, select the averaging or high resolution mode on your oscilloscope. Compensate the probe by adjusting **LF** on the probe compensation box so that the corners of the square wave are square. (See Figure 3 on page 7.)



WARNING. To avoid electric shock, only connect to the Probe Comp signal on the oscilloscope when making this adjustment. Only use the insulated adjustment tool when making compensation adjustments.

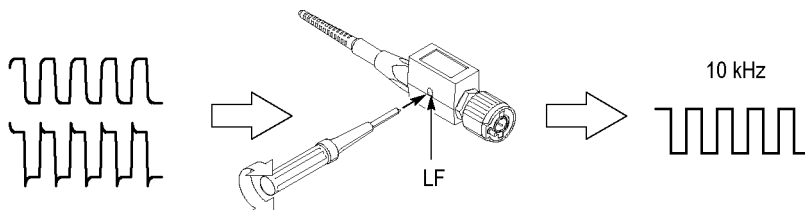

Figure 3: Coarse (LF) Compensation Adjustment

Cleaning

The P5100 probe is designed for high voltage use and should be kept as clean as possible. Surface conduction across the probe body caused by dirt and grease may present an electrical safety hazard.



CAUTION. *To avoid damage to the instrument, do not expose it to sprays, liquids, or solvents. Do not use chemical cleaning agents; they may damage the instrument. Avoid chemicals that contain benzene, toluene, xylene, acetone, or similar solvents.*

Clean the exterior surfaces of the instrument with a dry, lint-free cloth or a soft-bristle brush. If dirt remains, use a cloth or swab dampened with a 75% isopropyl alcohol solution. A swab is useful for cleaning in narrow spaces around the controls and connectors. Do not use abrasive compounds on any part of the instrument.



CAUTION. *Avoid getting moisture inside the instrument during exterior cleaning and use only enough solution to dampen the cloth or swab. Use a 75% isopropyl alcohol solution as a cleanser, and rinse with deionized water.*

Preparation for Shipment

If you need to ship your probe, pack it carefully to prevent its being damaged while in transit. If the original packaging is unfit for use or not available, use the following packaging guidelines:

1. Use a corrugated cardboard shipping carton having inside dimensions at least one inch greater than the probe dimensions. The box should have a carton test strength of at least 200 pounds.
2. Put the probe into a plastic bag or wrap to protect it from dampness in transit.
3. Place the probe into the box and stabilize it with light packing material.
4. Seal the carton with shipping tape.

Performance Verification

Use these performance verification procedures to verify that the P5100 probe meets the warranted specifications. These procedures should be performed in the order given using a TDS724C oscilloscope with the equipment recommended in the following table.



WARNING. *The following instructions are for use by qualified service personnel only. To avoid electrical shock, do not disassemble or maintain the probe while it is connected to a signal source other than those specified in this procedure.*

NOTE. *The probe must be low-frequency compensated before performance can be verified.*

If your probe fails to qualify under these conditions, service-level adjustments (DC gain and high-frequency compensation) are required. These adjustments must be done by a trained service person.

Table 1: Recommended Test Equipment

Equipment	Minimum Requirements	Recommended Equipment
Oscilloscope	350 MHz	Tektronix TDS724C
Calibration generator	≤1 ns rise time square wave 100 V square wave	Tektronix PG506A
Leveled signal generator	50 kHz to 250 MHz	Tektronix SG503
Termination, 50 Ω feedthrough	50 Ω male-to-female BNC	Tektronix 011-0049-XX
Adapter, BNC	Female-to-female barrel	Tektronix 103-0028-XX
Adapter, probe tip-to-BNC	Probe tip-to-male BNC	Tektronix 013-0291-XX
BNC cable, precision	No substitute ¹	Tektronix 012-0482-XX

¹ Required for use with Tektronix SG503.

DC Accuracy Check

1. Connect the DC accuracy test setup as shown.

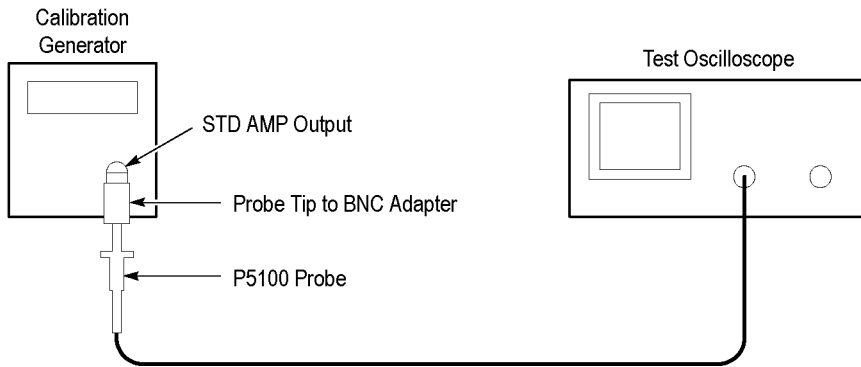

Figure 4: DC Accuracy Test Setup

2. Set the oscilloscope to 20 V/division (200 mV/division without scale factor).
3. Set the Calibration Generator **AMPLITUDE** to 100 V.
4. Adjust the **VARIABLE (OUT)** control on the Calibration Generator for a signal exactly five divisions in amplitude.

NOTE. The Amplitude measurement selection on the oscilloscope may be used to confirm the signal amplitude.

5. Note the percent error displayed and compare it to the value given for the System Attenuation specification. (See Table 2 on page 20.)

If your probe does not meet the DC accuracy requirement, service-level adjustments (DC gain and high-frequency compensation) are required. These adjustments must be done by a trained service person.

Bandwidth Check

1. Connect the test setup as shown.

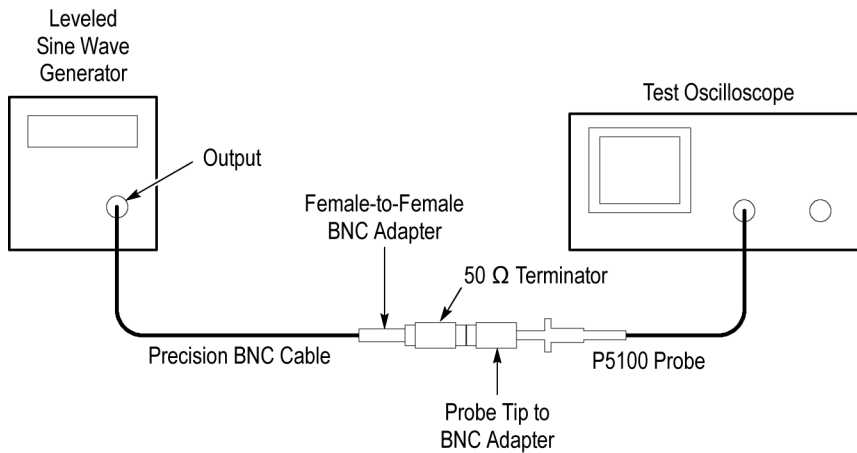

Figure 5: Bandwidth Test Setup

2. Set the Levelled Signal Generator output frequency to **REF $\geq .05$** .
3. Set the oscilloscope to 500 mV/division (5 mV/division without scale factor).
4. Adjust the Levelled Signal Generator for a display exactly 6 divisions peak-to-peak.
5. Increase the Levelled Signal Generator frequency until the display is 4.2 divisions peak-to-peak. (This represents the .707 or half-power amplitude.)
6. Note that the frequency is greater than 250 MHz.

If the probe does not meet the bandwidth requirement, service-level adjustments (DC gain and high-frequency compensation) are required. These adjustments must be done by a trained service person.

Adjustments

This section covers the adjustments and maintenance that must be done by a trained service person.

DC Gain and High Frequency (HF) Compensation

Precision, or high-frequency, compensation is not a common user adjustment; however, precision compensation should be checked if the probe was repaired or if any of the following conditions are true:

- The probe has excessive high-frequency aberrations.
- The probe fails to meet rated bandwidth specifications.
- You have installed the probe on an oscilloscope having an input capacitance near the limits of the probe compensation range. (See Figure 3 on page 7.)

To perform the high-frequency compensation adjustment you will need a signal source that has all of the following characteristics:

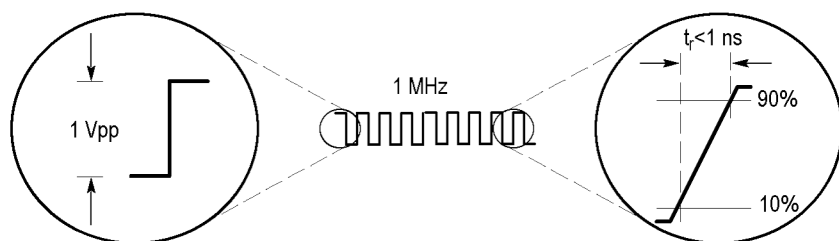

- Square-wave output at 1 MHz
- Fast rise output with rise time less than 1 ns
- Output properly terminated

The Tektronix PG506A Calibration Generator FAST RISE output meets these requirements when properly terminated.

Gain Adjustment (DC Accuracy)

NOTE. *If you adjust the DC gain, you must readjust the low frequency compensation; the DC gain and low frequency compensation adjustments interact with each other.*

1. Remove the top and bottom covers of the compensation box. To remove the covers, insert a thin flat-blade screwdriver between the shell covers and gently rotate the screwdriver to loosen the covers.
2. Connect the probe compensation box to the test oscilloscope.
3. Connect the probe tip to the unterminated **STD** output of the calibration generator using the optional probe tip to BNC adapter. (See Figure 6.)

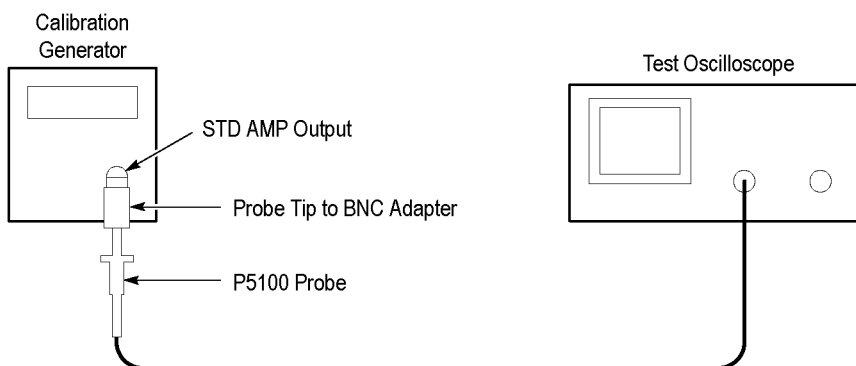

Figure 6: Gain Adjustment Setup

4. Set the calibration generator **AMPLITUDE** to 100 V.
5. Set the oscilloscope to 20 V/division (200 mV/division without scale factor).
6. Adjust the oscilloscope to display two to five cycles of the test signal.



WARNING. *To reduce risk of electric shock, use only the provided insulated adjustment tool when making adjustments. Hazardous voltages may be present inside the compensation box.*

7. Locate the **HF1**, **HF2**, and **DC Gain** adjustments. (See Figure 7.)

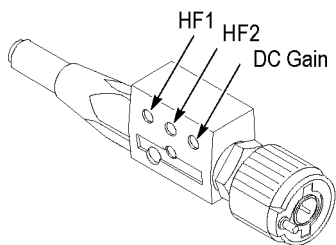

Figure 7: P5100 Adjustment Locations

8. Adjust **DC Gain** for exactly five divisions of signal amplitude at the falling edges of the waveform. (The **HIGH** measurement function of the oscilloscope may also be used to check DC gain).
9. Recheck the LF compensation.
10. Repeat the DC gain and LF compensation procedures until both are balanced.
11. Proceed to the HF adjustment.

High-Frequency (HF) Adjustment

1. Connect a 50 Ω feedthrough termination to the positive-going **FAST RISE** output of the calibration generator. (See Figure 8.)

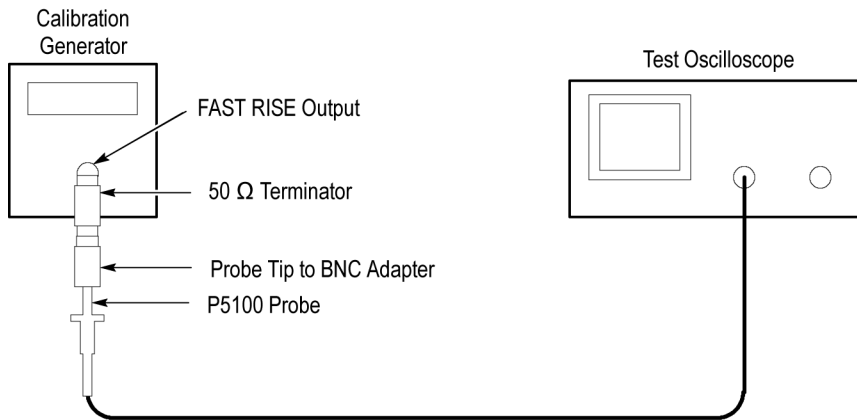

Figure 8: HF Adjustment Setup

2. Using the optional probe tip to BNC adapter, connect the probe to the termination.
3. Set the Calibration Generator to 1 MHz.
4. Set the **PULSE AMPLITUDE** to maximum.
5. Set the oscilloscope to 200 mV/division (2 mV/division without scale factor).
6. Set the oscilloscope averaging to 8.
7. Set the oscilloscope to 20 ns/div. (Adjust the oscilloscope as necessary to view the leading edge of the waveform.)

8. Adjust **HF2** for long term flatness.
9. Adjust **HF1** for a square leading edge. (See Figure 9.)

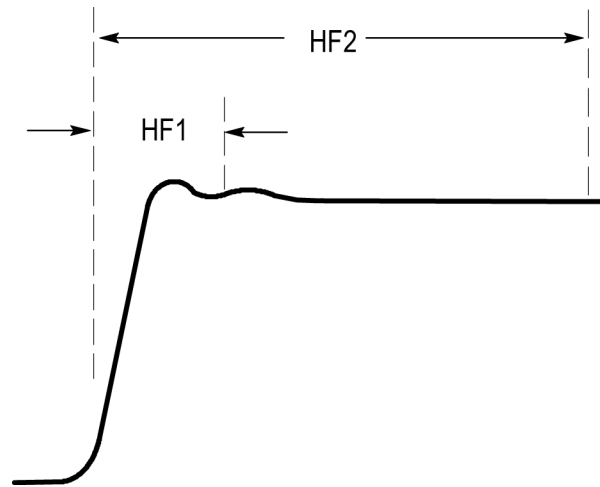

Figure 9: HF Compensation Adjustments

10. Reinstall the compensation box top and bottom covers.

Maintenance

Replacing Probe Parts

The P5100 probe has two major components: the probe head and cable assembly and compensation box. Accessory parts may be ordered as indicated in the replaceable parts list.

NOTE. *If you replace either the probe cable or the compensation box, you must perform a low- and high-frequency compensation of the probe before returning it to service. (See page 7, Low Frequency (LF) Probe Compensation.) (See page 12, DC Gain and High Frequency (HF) Compensation.)*

Use the following procedure to replace the compensation box or cable and probe head assemblies. (See Figure 10 on page 17.)

1. Using an adjustable or 1/2 inch (13 mm) wrench, loosen the compensation box cable retaining nut and slide it back.
2. Lightly grasp the cable strain relief and pull the cable out of the compensation box.
3. Slide the cable retaining nut off of the old cable and onto the new one.
4. Push the new cable connector into the compensation box and press it into place.
5. Using the wrench, gently tighten the cable retaining nut into place until it is snug.

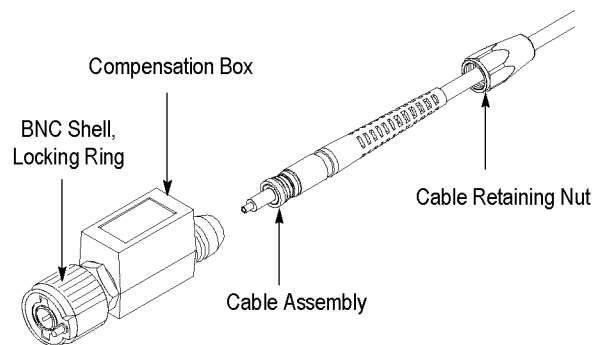

Figure 10: Probe Disassembly

Specifications

Specifications that are not warranted are typical and are provided as general information.

The following specification tables apply to a P5100 probe installed on a Tektronix TDS724C oscilloscope. When used with another instrument, the oscilloscope must have a bandwidth not less than 350 MHz, an input impedance of 1 M Ω , an input capacitance within the specified compensation. (See Table 3 on page 21.)



WARNING. *To avoid electric shock and possible injury, do not apply any voltage above earth ground potential (0-volt potential) to the probe common lead (do not float the common). The exposed metal on the probe compensation box is electrically connected to the probe common lead and therefore is at the same potential.*

The P5100 voltage probe is intended for use with ground-referenced oscilloscopes only. Do not float the oscilloscope by removing or isolating the ground pin from the AC power cord. Do not use the P5100 voltage probe with any equipment with floating inputs, including the TPS2000 or THS700 series oscilloscopes.

The instrument must have a warm-up period of 20 minutes and be in an environment that meets the specified requirements. (See Table 5 on page 22.)

Table 2: Warranted Electrical Specifications

Characteristics	Description
Attenuation (system)	X100, ±1.75%
-3 dB Bandwidth (system)	DC to 250 MHz
Maximum rated input voltage (See Figure 12.)	2500 V (DC + peak AC) CAT I, with rated overvoltage transients (impulses) up to 4500 Vpk. (See Figure 11.) 1000 V rms, CAT III

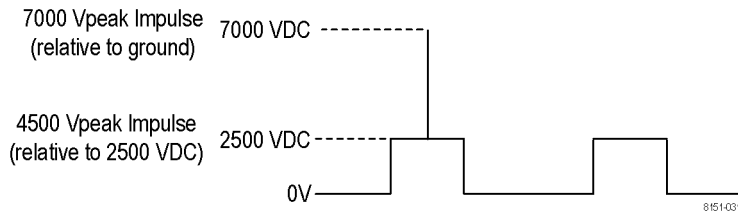

Figure 11: Maximum overvoltage transients

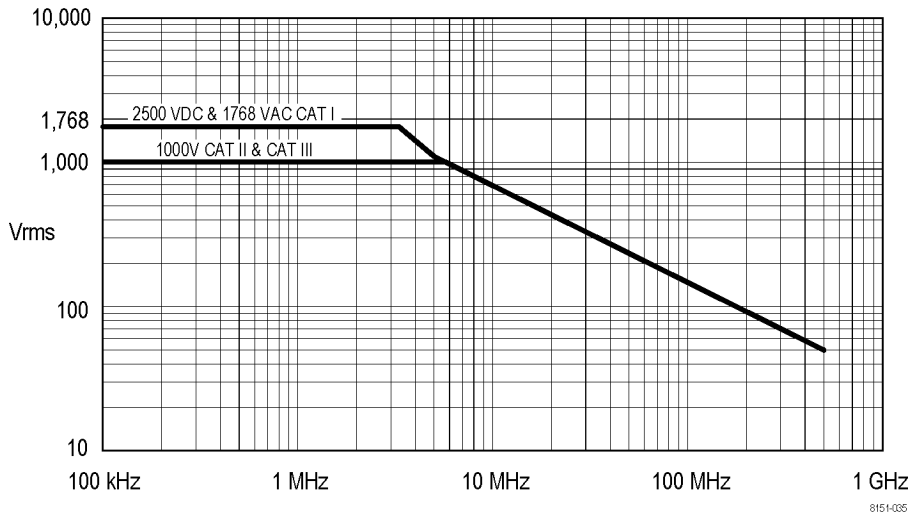

Figure 12: Maximum Input Voltage to Frequency Derating Curve (DC + peak AC)

Table 3: Typical Electrical Characteristics

Characteristics	Description
Rise time (system)	<1.75 ns
Input impedance (system)	10 MΩ (See Figure 13.)
Compensation range	7 pF to 30 pF
Input capacitance (system) Checked at 1 MHz.	<2.75 pF

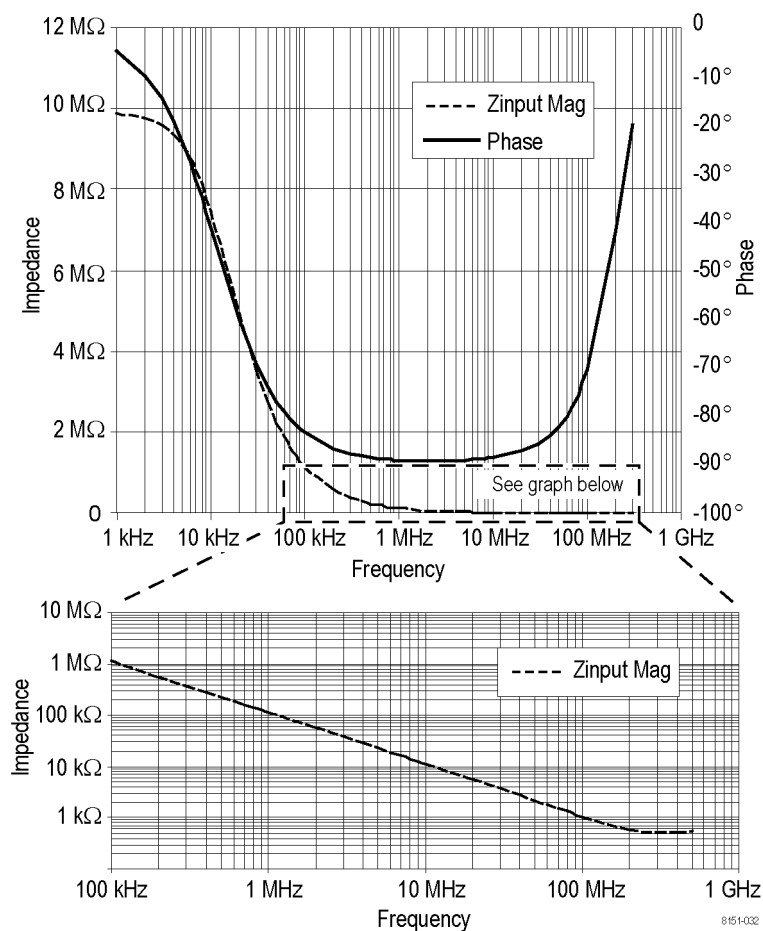

Figure 13: Typical Input Phase and Impedance

Table 4: Typical Mechanical Characteristics

Characteristics	Description
Net Weight (including accessories)	227 g (0.5 lb.)
Cable Length	3.1 m (10 ft.)

Table 5: Warranted Environmental Specifications

Characteristics	Description
Temperature	Nonoperating: -40 °C to +71 °C (-40 °F to +160 °F) Operating: 0 °C to +50 °C (+32 °F to +122 °F)
Humidity	Nonoperating and operating: Five cycles (120 hr. total) at 90% to 95% relative humidity.
Altitude	2,000 m (~ 6,600 ft).

Replaceable Parts

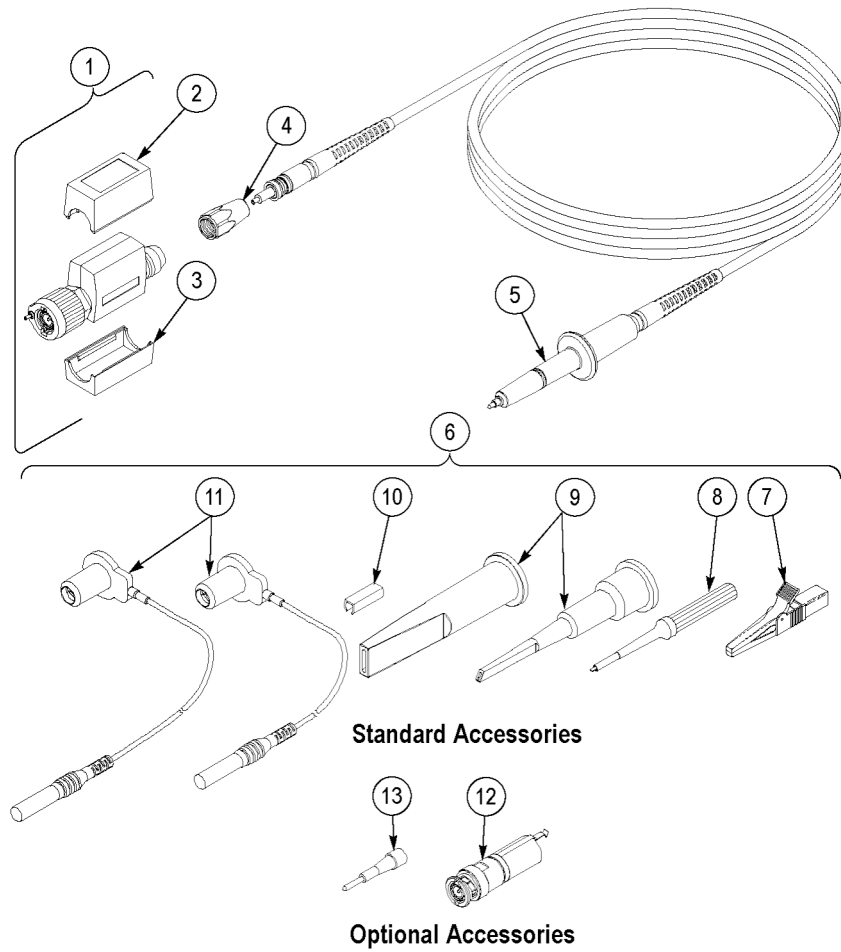

Figure 14: P5100 Replaceable Parts

Table 6: Replaceable Parts List

Fig. & Index Number	Tektronix Part Number	Qty	Name & Description
14-		1	P5100, PROBE, HI VOLTAGE:100X,250 MHz
-1	206-0466-XX	1	COMP BOX ASSY:P5100
-2	200-3016-XX	1	COVER,COMP BOX:TOP,ABS DOVE GRAY
-3	200-3017-XX	1	COVER,COMP BOX:BOTTOM,ABS SLATE GRAY
-4	200-3018-XX	1	COVER,CABLE NIP:COMP BOX
-5	206-0465-10	1	PROBE HEAD ASSY:P5100,100X W/CABLE ASSY
STANDARD ACCESSORIES			
-6	020-2137-XX	1	ACCESS KIT:LEADS,ADAPTERS AND MARKER

Table 6: Replaceable Parts List (cont.)

Fig. & Index Number	Tektronix Part Number	Qty	Name & Description
-7	344-0461-XX	1	CLIP,ELEC:CROCODILE, 82MM L,4MM
-8	003-1433-XX	1	SCREWDRIVER: ADJUSTMENT TOOL,METAL TIP
-9	013-0290-XX	1	HOOKTIP,SET:HOOKTIP ASSY,LARGE AND SMALL
-10	334-1275-XX	2	CLIP,CABLE MKR:RED,PLASTIC
	334-1275-XX	2	CLIP,CABLE MKR:YELLOW,PLASTIC
	334-1275-XX	2	CLIP,CABLE MKR:GREEN,PLASTIC
-11	196-3424-XX	1	LEAD SET ASSY:PROBE,GROUND,1 EA,18.0 L,6.0 L
	070-8151-XX	1	MANUAL,TECH: INSTRUCTIONS, P5100,DP
OPTIONAL ACCESSORIES			
-12	013-0291-XX	1	ADAPTER,PROBE:PROBE TO BNC,P5100
-13	206-0060-XX	1	TIP,PROBE:P6000