



## Film Capacitors - AC Capacitors

### General Purpose MKP AC Capacitors

**Series/Type:** CBB65A-1  
**Ordering code:** B33331V series  
**Date:** 2019-04-10  
**Version:** 2

**Construction**

- Metallized polypropylene film
- Filling material: soft polyurethane resin
- Aluminum can and top

**Features**

- Overpressure disconnection safety device
- UL approved for diameter > 40 mm
- Humidity protected: 85 °C, 85 % rel. humidity (RH) at 460 V for 1000 h
- Low dissipation factor
- Self-healing technology
- Indoor mounting
- CE compatible

**Typical applications**

- For general AC filtering application

**Terminals**



- 2+2 fast-on terminal 6.3 x 0.8mm #250 style, others on request

**Mounting parts (optional)**

- Threaded stud at bottom of can  
(M8, max torque = 5 Nm for 50 mm diameter)



Technical data and specifications	
Reference standards	IEC 61071, UL 810
Rated voltage V <sub>R</sub>	650 V
Rated AC RMS voltage V <sub>RMS</sub>	460 V
Rated capacitance C <sub>R</sub>	See table
Tolerance	± 5%
Dielectric Dissipation factor tan δ <sub>0</sub> at +20 °C	≤ 2 · 10 <sup>-4</sup> at 1 kHz
Life test	IEC 61071
Life expectancy	100 000 h for V <sub>RMS</sub>  ΔC/C  ≤3%
Maximum ratings	
Maximum permissible voltage V <sub>max</sub>	1.10 • V <sub>R</sub> : 8 h/day 1.15 • V <sub>R</sub> : 30 min/day 1.20 • V <sub>R</sub> : 5 min/day 1.30 • V <sub>R</sub> : 1 min/day
Maximum permissible current I <sub>max</sub>	See table

<b>Test data</b>	
AC test voltage terminal to terminal $V_{TT}$	975 V, 2 s
AC test voltage terminal to case $V_{TC}$	2200 V, 2 s
Dissipation factor $\tan \delta$ at + 20 °C	$\leq 10 \cdot 10^{-4}$ at 120 Hz
<b>Climatic data</b>	
Climatic category	40/085/21 to IEC 60068-1
Lower category $\theta_{min}$	-40° C
Upper category $\theta_{max}$	+85° C
Maximum hot spot temperature $\theta_{HS}$	+85° C
Damp heat test $t_{test}$	21 days
<b>Enforced humidity protection</b>	
Temperature	+85 °C
Relative humidity	85 %
Duration	1000 h
Applied voltage	$U_{RMS}$
Criteria	Capacitance deviation $\Delta C$ at +20 °C < $\pm 10\%$ Dissipation factor variation $\Delta \tan \delta$ at +20 °C < +0.005
<b>Mechanical and thermal properties of terminal insulator material</b>	
Terminal material: UL 94 V0 compatible	Self-extinguishing within 2 seconds of withdrawing glow wire without igniting wrapping tissue of GWT
<b>Compatibility to RoHS</b>	
Compliance to directive 2011/65/EU	
<b>Approvals</b>	
 US UL File E 238746	Approved component 10000 AFC. See table for approved ratings
	Compliance to LV directive 2014/35/EU

**Dimensional drawings and marking**

Note: Check the table before marking UL.

UL to be marked only for rating between 25  $\mu$ F to 50  $\mu$ F.

Don't mark UL for rating between 2  $\mu$ F to 20  $\mu$ F. In the blank space, the marking can be shifted left.

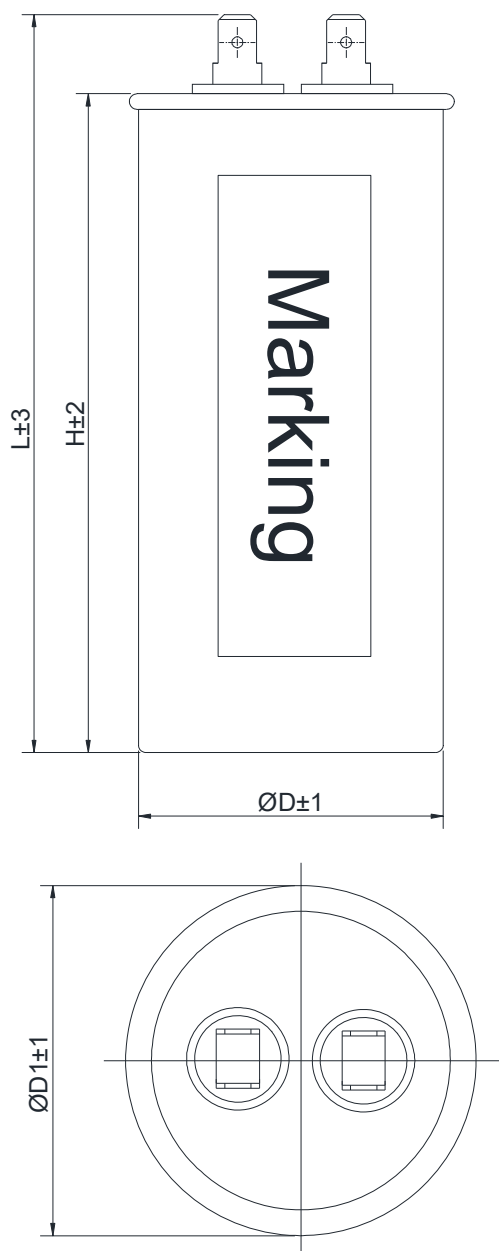
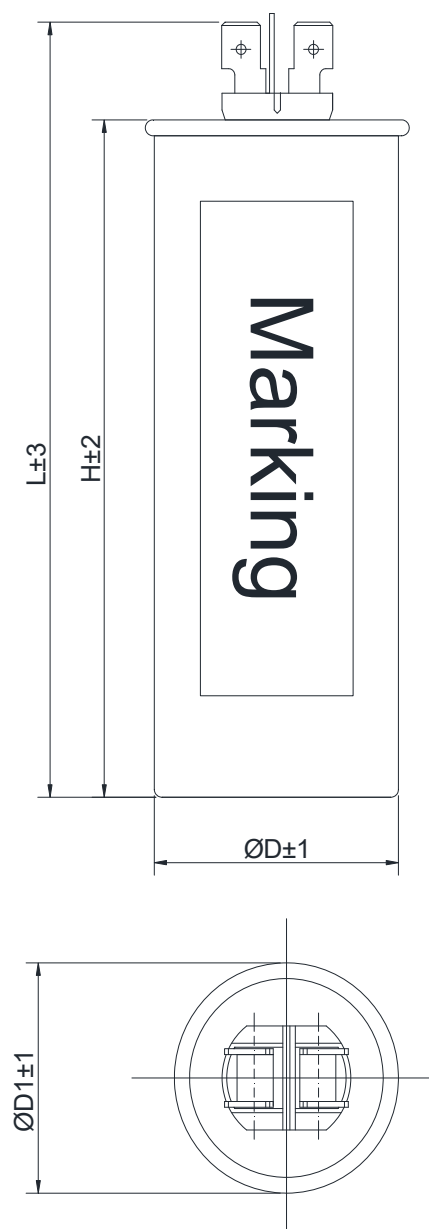
**Drawing 1**

**Drawing 2**

**Marking specification**
**With UL**

$C_R$  uF  
 +/-5%  $V_{RMS}$  460V~  $WW.YYN$   
 $U_N$  650V~  
 No PCB's CBB65A-1 IEC 61071 50/60Hz  
 B33331V 40/85/21 Protected E238746  
 Overpressure disconnecter SH 10 K  
 Discharge before handling  
 Made by EPCOS P.O. No.

**Without UL**

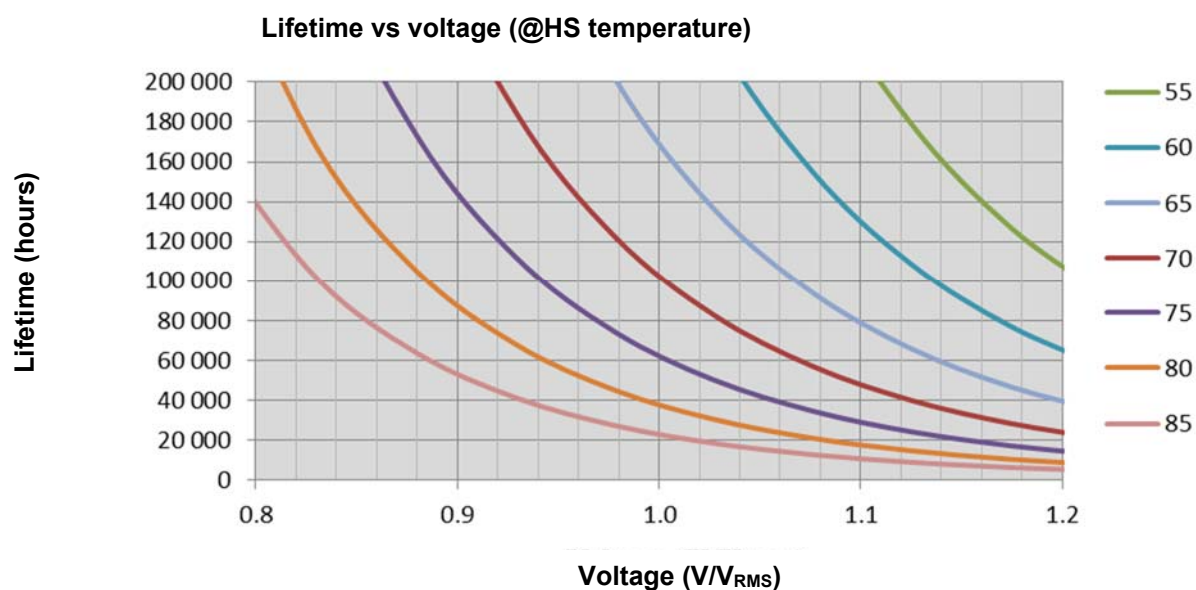
$C_R$  uF  $WW.YYN$   
 +/-5%  $V_{RMS}$  460V~  $U_N$  650V~  
 No PCB's CBB65A-1 IEC 61071  
 B33331V 40/85/21 Protected  
 Overpressure disconnecter 50/60Hz  
 Discharge before handling SH  
 Made by EPCOS P.O. No.

**Expected lifetime**

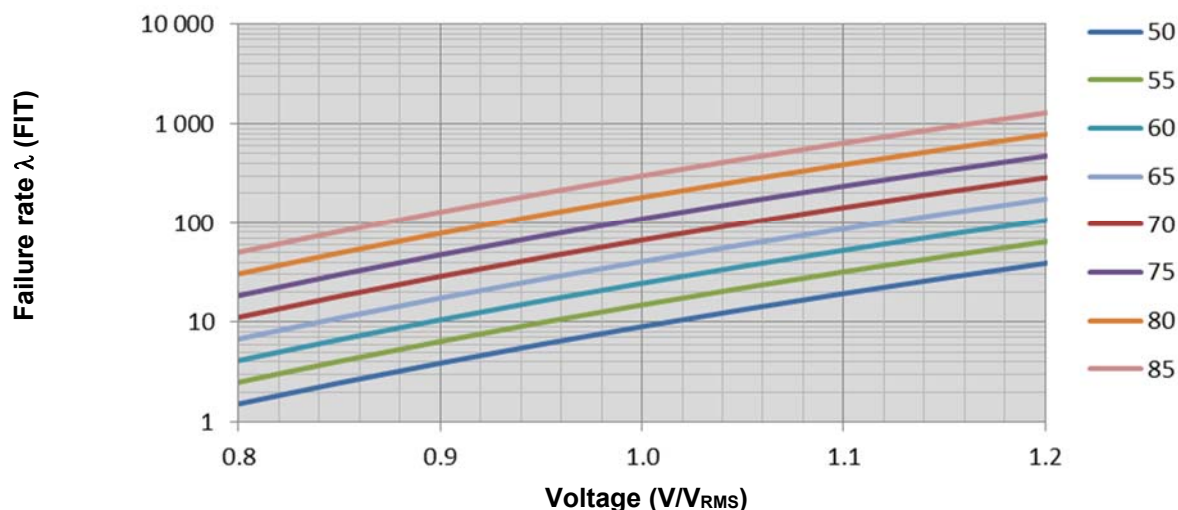
**Expected fit rate**
**Failure rate  $\lambda$  vs voltage (@HS temperature)**

**Ordering codes and packing unit**

$V_R$	$C_R$	$I_{max}^{1)}$	$\hat{r}$	ESR <sup>2)</sup>	Case (D x H)	$D_1$	L	Drawing	Ordering code	Packing unit	Approval
$V_{RMS}$	$\mu F$	A	A	m $\Omega$	mm	mm	mm				
650 $V_R$	2	6	55	35	30 x 55	33	73	2	B33331V7205J0#X	100	
	4	7	75	23	30 x 65	33	83	2	B33331V7405J0#X	100	
	6	8	100	21	30 x 65	33	83	2	B33331V7605J0#X	100	
	8	9	140	17	30 x 65	33	83	2	B33331V7805J0#X	100	
	10	10	130	19	30 x 75	33	93	2	B33331V7106J0#X	100	
460 $V_{RMS}$	12	12	210	13	40.5 x 65	43.5	78	1	B33331V7126J0#X	49	
	14	12	200	11	40.5 x 65	43.5	78	1	B33331V7146J0#X	49	
	16	12	210	12	40.5 x 75	43.5	88	1	B33331V7166J0#X	49	
	20	15	260	11	40.5 x 85	43.5	98	1	B33331V7206J0#X	49	
	25	16	260	12	45 x 85	48	98	1	B33331V7256J0#X	49	UL
	30	16	340	10	50 x 85	53	98	1	B33331V7306J0#X	36	UL
	40	16	350	11	50 x 100	53	113	1	B33331V7406J0#X	36	UL
	50	16	410	14	50 x 100	53	113	1	B33331V7506J0#X	36	UL

<sup>1)</sup>  $I_{max}$  – Maximum RMS current for continuous operation defined for a hotspot of  $\leq 85$  °C, case temperature of  $\leq 60$  °C, including harmonics up to frequency of 20 kHz.

<sup>2)</sup> ESR – Equivalent Series resistance at 1KHz

**Composition of ordering code**

#: construction

6 Aluminium can flat type

8 Aluminium can with M8 bolt

X:

0 as per this dimension and properties

1-9 special dimension and properties

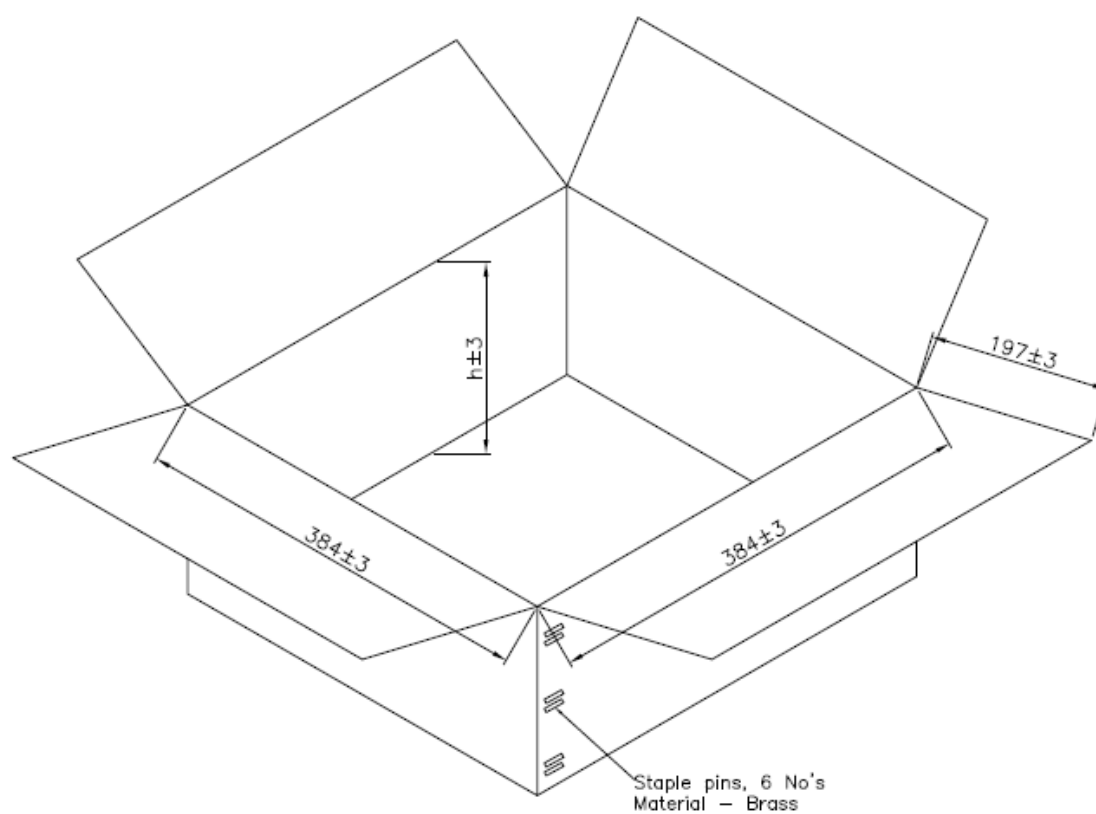
**Packing box**

$h = \text{capacitor height (H)} + \text{terminal height} + 10 \text{ mm min.}$

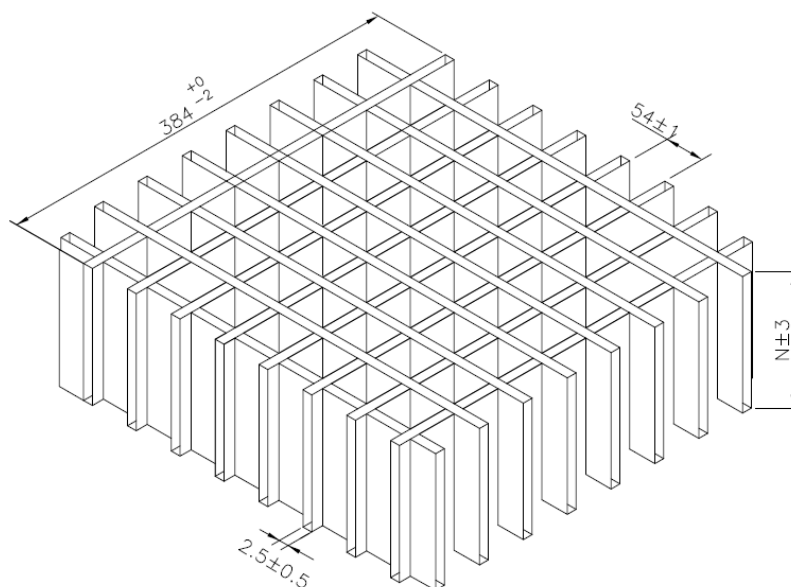

**Rated AC voltage  $V_R$**

Maximum operating peak voltage of either polarity of reversing type waveform for which the capacitor is designed

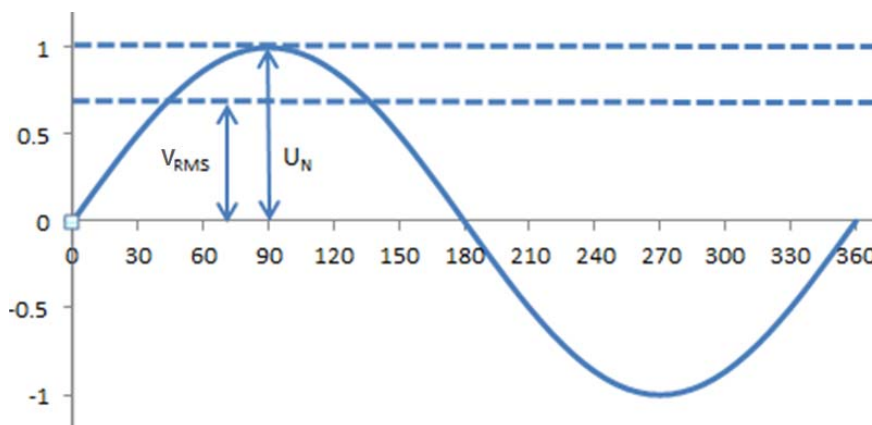

**Rated AC RMS voltage  $V_{RMS}$**

Root mean square of the maximum permissible value of sinusoidal AC voltage in continuous operation

**Rated capacitance  $C_R$**

Designed capacitance of the capacitor at 20 °C at 1 kHz

**Maximum continuous current  $I_{max}$**

Maximum RMS current for continuous operation, including harmonics



**Maximum peak current  $\hat{I}$** 

Maximum current amplitude which occurs instantaneously during continuous operation

The maximum peak current ( $\hat{I}$ ) and the maximum rate of voltage rise  $\left(\frac{dV}{dT}\right)_{max}$  of a capacitor are related as follows:

$$\hat{I} = C \cdot \left(\frac{dV}{dT}\right)_{max}$$

**Maximum surge current  $\hat{I}_s$** 

Admissible peak current induced by a switching or any other disturbance of the system which is allowed for a limited number of times

$$\hat{I}_s = C \cdot \left(\frac{dV}{dT}\right)_s$$

Maximum duration: 50 ms / pulse

Maximum number of occurrences: 1000 (during load)

**Equivalent series resistance ESR**

Effective resistance which, if connected in series with an ideal capacitor of capacitance value equal to that of the capacitor in question, would have a power loss equal to active power dissipated in that capacitor under specified operating conditions.

**Self-inductance  $L_{self}$** 

Series inductance of the terminals and the winding

With self-inductance, it is possible to determine the resonance frequency.

$$f = \frac{1}{2\pi \cdot \sqrt{L_{self} \cdot C}}$$

**Harmonics**

Harmonics result from the operation of electrical loads with non-linear voltage-current characteristics. It is necessary to calculate the temperature rise of the capacitors from hotspot to case during the using process. If the temperature rise of theoretical calculation of capacitor's hotspot exceeds the maximum allowable range, we would propose to check the total harmonic current distortion (THD<sub>i</sub>) of the input terminals.

$$THD_i = \frac{\sqrt{\sum_{n=1}^{\infty} I_n^2}}{I_1}$$

**Thermal load**

After installation of the capacitor, it is necessary to verify that maximum hot-spot temperature is not exceeded at extreme service conditions.

**Mechanical protection**

The capacitor has to be installed in a way that mechanical damages and dents in the aluminum can are avoided.

### Storage and operating conditions

Do not use or store capacitors in corrosive atmosphere, especially where chloride gas, sulfide gas, acid, alkali, salt or the like are present. In dusty environments, regular maintenance and cleaning especially of the terminals is required to avoid conductive path between phases and/or phases and ground. The maximum storage temperature is 85 °C.

### Service life expectancy

Electrical components do not have an unlimited service life expectancy; this applies to self-healing capacitors, too. The maximum service life expectancy may vary depending on the application for which the capacitor is used.

### Overpressure disconnecter

To ensure full functionality of an overpressure disconnecter, the following must be observed:

- The elastic elements must not be hindered, i.e.
  - connecting lines must be flexible leads (cables).
  - there must be sufficient space for expansion above the connections.
  - folding seams must not be retained by clamps.
- Stress parameters of the capacitor must be within the IEC 61071 specification.

### Safety

- Electrical or mechanical misapplication of capacitors may be hazardous. Personal injury or property damage may result from bursting of the capacitor or from expulsion of oil or melted material due to mechanical disruption of the capacitor.
- Ensure good, effective grounding for capacitor enclosures.
- Observe appropriate safety precautions during operation (self-recharging phenomena and the high energy contained in capacitors).
- Handle capacitors carefully, because they may still be charged even after disconnection.
- The terminals of capacitors, connected bus bars and cables as well as other devices may also be energized.
- Follow good engineering practice.

### Cautions and warnings

- In case of dents of more than 1 mm depth or any other mechanical damage, capacitors must not be used at all. This applies also in cases of leakage.
- To ensure the full functionality of the overpressure disconnecter, elastic elements must not be hindered and a minimum space of 12 mm has to be kept above each capacitor.
- Check tightness of the connections/terminals periodically.
- The energy stored in capacitors may be lethal. To prevent any chance of shock, discharge and short-circuit the capacitor before handling.
- Failure to follow cautions may result, worst case, in premature failures, bursting and fire.
- TDK Electronics is not responsible for any kind of possible damages to persons or things due to improper installation and application of capacitors for power electronics.

### Display of ordering codes for TDK Electronics products

The ordering code for one and the same product can be represented differently in data sheets, data books, other publications, on the company website, or in order-related documents such as shipping notes, order confirmations and product labels. **The varying representations of the ordering codes are due to different processes employed and do not affect the specifications of the respective products.** Detailed information can be found on the Internet under [www.tdk-electronics.tdk.com/orderingcodes](http://www.tdk-electronics.tdk.com/orderingcodes).

## Important notes

The following applies to all products named in this publication:

1. Some parts of this publication contain **statements about the suitability of our products for certain areas of application**. These statements are based on our knowledge of typical requirements that are often placed on our products in the areas of application concerned. We nevertheless expressly point out **that such statements cannot be regarded as binding statements about the suitability of our products for a particular customer application**. As a rule we are either unfamiliar with individual customer applications or less familiar with them than the customers themselves. For these reasons, it is always ultimately incumbent on the customer to check and decide whether a product with the properties described in the product specification is suitable for use in a particular customer application.
2. We also point out that **in individual cases, a malfunction of electronic components or failure before the end of their usual service life cannot be completely ruled out in the current state of the art, even if they are operated as specified**. In customer applications requiring a very high level of operational safety and especially in customer applications in which the malfunction or failure of an electronic component could endanger human life or health (e.g. in accident prevention or life-saving systems), it must therefore be ensured by means of suitable design of the customer application or other action taken by the customer (e.g. installation of protective circuitry or redundancy) that no injury or damage is sustained by third parties in the event of malfunction or failure of an electronic component.
3. **The warnings, cautions and product-specific notes must be observed.**
4. In order to satisfy certain technical requirements, **some of the products described in this publication may contain substances subject to restrictions in certain jurisdictions (e.g. because they are classed as hazardous)**. Useful information on this will be found in our Material Data Sheets on the Internet ([www.tdk-electronics.tdk.com/material](http://www.tdk-electronics.tdk.com/material)). Should you have any more detailed questions, please contact our sales offices.
5. We constantly strive to improve our products. Consequently, **the products described in this publication may change from time to time**. The same is true of the corresponding product specifications. Please check therefore to what extent product descriptions and specifications contained in this publication are still applicable before or when you place an order.

We also **reserve the right to discontinue production and delivery of products**. Consequently, we cannot guarantee that all products named in this publication will always be available. The aforementioned does not apply in the case of individual agreements deviating from the foregoing for customer-specific products.

6. Unless otherwise agreed in individual contracts, **all orders are subject to our General Terms and Conditions of Supply**.
7. **Our manufacturing sites serving the automotive business apply the IATF 16949 standard**. The IATF certifications confirm our compliance with requirements regarding the quality management system in the automotive industry. Referring to customer requirements and customer specific requirements ("CSR") TDK always has and will continue to have the policy of respecting individual agreements. Even if IATF 16949 may appear to support the acceptance of unilateral requirements, we hereby like to emphasize that **only requirements mutually agreed upon can and will be implemented in our Quality Management System**. For clarification purposes we like to point out that obligations from IATF 16949 shall only become legally binding if individually agreed upon.

## Important notes

8. The trade names EPCOS, CeraCharge, CeraDiode, CeraLink, CeraPad, CeraPlas, CSMP, CTVS, DeltaCap, DigiSiMic, ExoCore, FilterCap, FormFit, LeaXield, MiniBlue, MiniCell, MKD, MKK, MotorCap, PCC, PhaseCap, PhaseCube, PhaseMod, PhiCap, PowerHap, PQSine, PQvar, SIFERRIT, SIFI, SIKOREL, SilverCap, SIMDAD, SiMic, SIMID, SineFormer, SIOV, ThermoFuse, WindCap are **trademarks registered or pending** in Europe and in other countries. Further information will be found on the Internet at [www.tdk-electronics.tdk.com/trademarks](http://www.tdk-electronics.tdk.com/trademarks).

Release 2018-10

# Mouser Electronics

Authorized Distributor

Click to View Pricing, Inventory, Delivery & Lifecycle Information:

## EPCOS / TDK:

[B33331V7306J080](#) [B33331V7405J080](#) [B33331V7406J080](#) [B33331V7506J080](#) [B33331V7605J080](#)  
[B33331V7805J080](#) [B33331V7205J080](#) [B33331V7206J080](#) [B33331V7256J080](#) [B33331V7106J080](#)  
[B33331V7126J080](#) [B33331V7146J080](#) [B33331V7166J080](#)